

Ref.12007

■ 2x2x400mm

x2

■ 2x3x400mm

x4

| 0,6x5x400mm

x40

| 0,6x5x400mm

x40

■ 2x5x400mm

x40

■ 2x5x400mm

x1

■ 4x4x400mm

x1

● ø3x400mm

x1

● ø4x400mm

x1

● ø5x400mm

x1

● ø6x400mm

x2

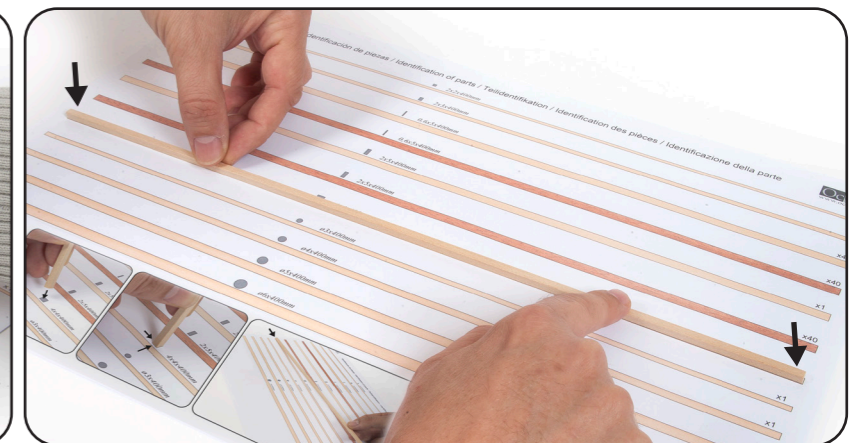
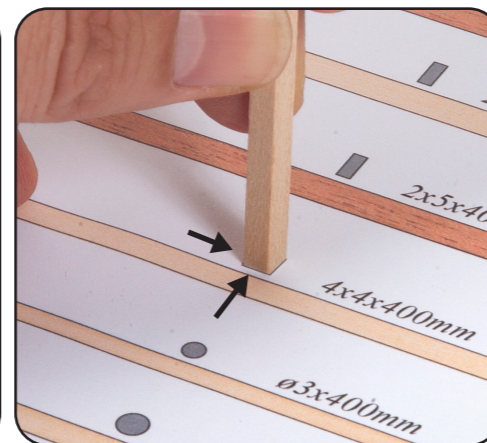
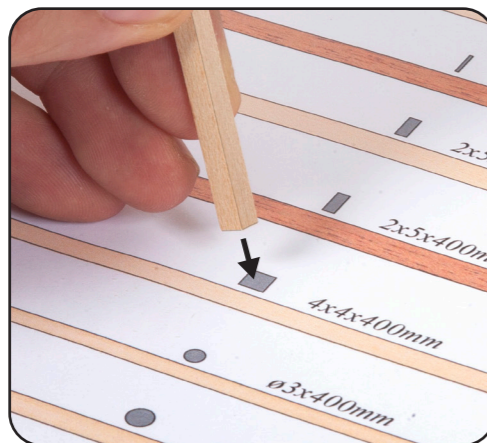

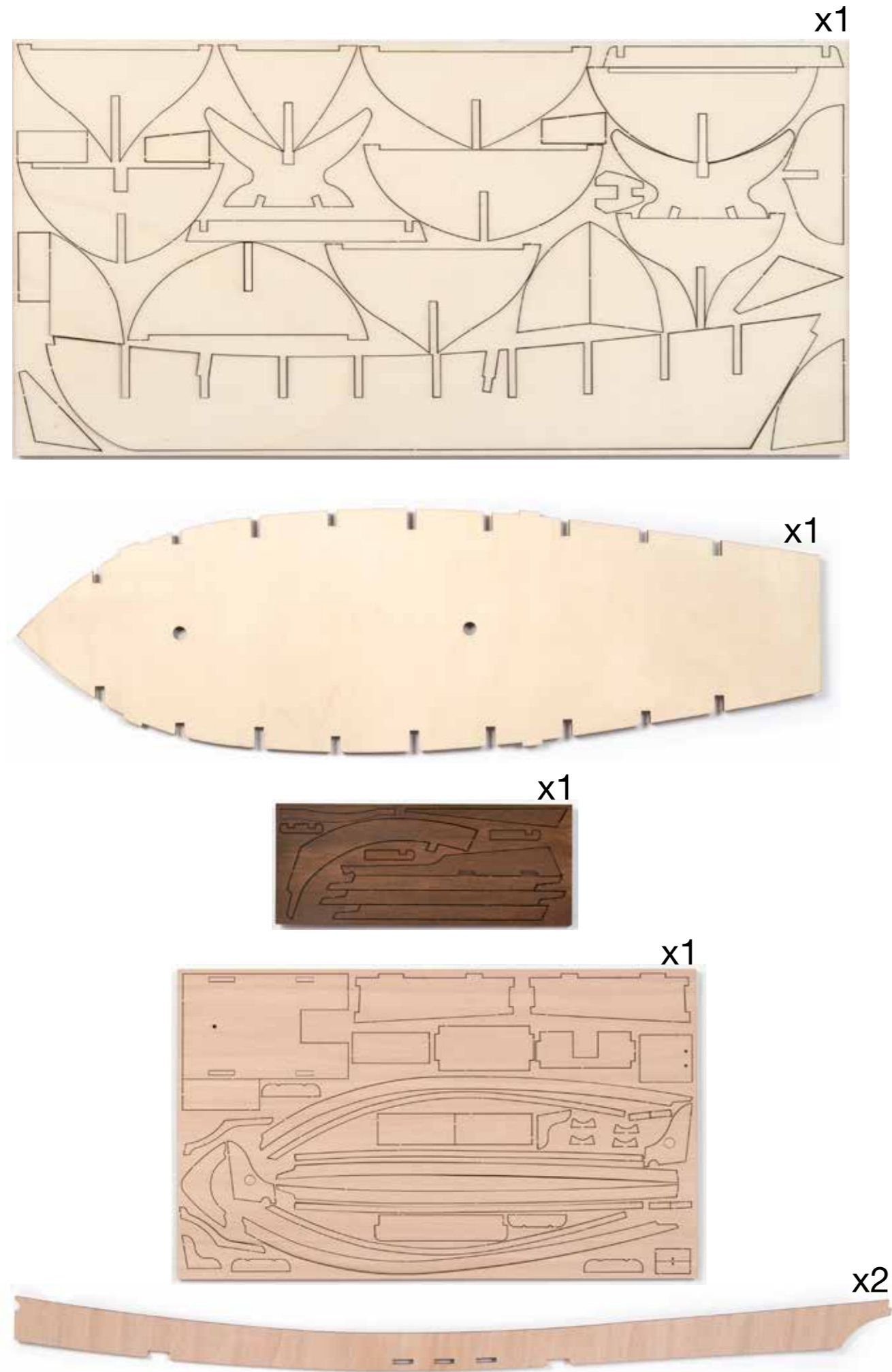



**Cola blanca o de carpintero/White, or carpenter's, glue.
Colle blanche ou de menuisier/Weißer Kleber (Tischlerleim).
Colla bianca o da falegname.**

Para unión de piezas de madera. Su mayor uso es en la construcción del esqueleto del casco y en la colocación del primer forro de éste. En todos los casos, siempre se seguirán las recomendaciones del fabricante.

For joining pieces of wood together. Mainly used for gluing together the skeleton of the hull and attaching the first layer of lining to it. In all cases, always follow the manufacturer's recommendations.

Pour l'assemblage de pièces en bois. On l'utilisera majoritairement pour la construction de la charpente de la coque et pour l'installation du premier bordé de celle-ci. Dans tous les cas, il faudra suivre les recommandations du fabricant.

Der Schusterleim wird zur Beplankung des Decks und für Teile verwendet, die mit dünnen Holzplättchen abgedeckt werden. Dieser Leim wird hauptsächlich zur Beplankung des Decks und zur zweiten Rumpfbeplankung verwendet. Bitte beachten Sie dabei stets die Hinweise des Herstellers.

Per unire i pezzi di legno. Si usa maggiormente nella costruzione dello scheletro dello scafo e per collocare il primo rivestimento dello scafo. In tutti i casi, seguire sempre le raccomandazioni del fabbricante.



Pinturas/Paints/Peintures/Farben/Pittura.

Se recomiendan pinturas acrílicas al agua. Para pequeñas superficies y detalles de piezas pequeñas de madera o metal. En todos los casos, siempre se seguirán las recomendaciones del fabricante.

Acrylic water paints are recommended. For small surfaces and parts details small wood or metal. In all cases, always follow the manufacturer's recommendations.

Les peintures acryliques à l'eau sont recommandées. Pour les petites surfaces et détails des pièces petit bois ou en métal. Dans tous les cas, il faudra suivre les recommandations du fabricant.

Acrylwasserfarben werden empfohlen. Für kleine Oberflächen und Teiledetails kleines Holz oder Metall. Bitte beachten Sie dabei stets die Hinweise des Herstellers.

Si raccomandano vernici ad acqua acriliche. Per piccole superfici e dettagli di parti in legno o metallo. In tutti i casi, seguire sempre le raccomandazioni del fabbricante.

Pegamento de secado rápido (cianoacrilato)/Quick-drying glue.

**Colle à séchage rapide/Sekundenkleber.
Collante ad asciugatura rapida.**

Para piezas que sean difíciles de mantener en su posición final y que necesiten un secado casi instantáneo. Recomendado para la colocación de piezas pequeñas sobre las cubiertas y distintas partes del casco y mástiles. En todos los casos, siempre se seguirán las recomendaciones del fabricante.

For parts that are difficult to hold in their final position and which need to set instantly. Recommended for fitting small parts onto the decks, different parts of the hull or the masts. In all cases, always follow the manufacturer's recommendations.

Pour pièces difficiles à maintenir dans leur position finale et requérant un séchage presque instantané. Recommandé pour l'installation de petites pièces sur les ponts et autres parties de la coque et des mâts. Dans tous les cas, il faudra suivre les recommandations du fabricant.

Für Teile, die schlecht in Position zu halten sind und schnell fixiert werden müssen. Empfohlen zum Aufkleben kleiner Bauteile auf das Deck und an Teile von Rumpf und Masten. Bitte beachten Sie dabei stets die Hinweise des Herstellers.

Per pezzi difficili da mantenere nella loro posizione finale e che richiedano una presa quasi rapida. Raccomandato per collocare i pezzi piccoli sulle coperte e su diverse parti della scafo ed alberi. In tutti i casi, seguire sempre le raccomandazioni del fabbricante.



Tintes/Dye/Colorant/Tönung/Dye.

Se recomiendan tintes al agua para madera. Para teñir las maderas de los listones, varillas y chapas. En todos los casos, siempre se seguirán las recomendaciones del fabricante.

Water dyes are recommended for wood. To dye the wood of the slats, rods and veneers.

In all cases, always follow the manufacturer's recommendations.

Les colorants à l'eau sont recommandés pour le bois. Teindre le bois des lattes, tiges et placages.

Dans tous les cas, il faudra suivre les recommandations du fabricant.

Für Holz werden Wasserfarben empfohlen. Das Holz der Lamellen, Stangen und Furniere färben.

Bitte beachten Sie dabei stets die Hinweise des Herstellers.

I coloranti ad acqua sono raccomandati per il legno. Per tingere il legno di doghe, aste e faccette.

In tutti i casi, seguire sempre le raccomandazioni del fabbricante.



Cola de contacto o de zapatero/Contact or cobbler's glue.

**Colle de contact ou de cordonnier/Kontakkleber (Schusterleim).
Colla da contatto o da calzolaio.**

Para la sujeción de los forros de cubiertas y piezas que se deban cubrir con chapas finas de madera. Generalmente se aplica en el forrado de cubiertas y el segundo forro del casco. En todos los casos, siempre se seguirán las recomendaciones del fabricante.

For gluing into place the decks and the parts that are covered with fine wood veneer. Generally it is used to attach the planking to the decks and the second layer of lining of the hull. In all cases, always follow the manufacturer's recommendations.

Pour la fixation des bordés des ponts et des pièces qui seront recouvertes de fines lamelles de bois. Appliquée généralement sur le bordage des ponts et le deuxième bordé de la coque. Dans tous les cas, il faudra suivre les recommandations du fabricant.

Der Schusterleim wird zur Beplankung des Decks und für Teile verwendet, die mit dünnen Holzplättchen abgedeckt werden. Dieser Leim wird hauptsächlich zur Beplankung des Decks und zur zweiten Rumpfbeplankung verwendet. Bitte beachten Sie dabei stets die Hinweise des Herstellers.

Per incollare i rivestimenti delle coperte e per i pezzi che devono poi essere ricoperti con fine lamina di legno. Generalmente si applica al rivestimento delle coperte e il secondo rivestimento dello scafo. In tutti i casi, seguire sempre le raccomandazioni del fabbricante.



Barnices/Varnishes/Vernis/Lacke/Vernici

El más usado es barniz tapaporos de acabado satinado. En todos los casos, siempre se seguirán las recomendaciones del fabricante.

The most used is pore-filling varnish with satin finish. In all cases, always follow the manufacturer's recommendations.

Le plus utilisé est le vernis de remplissage des pores avec une finition satinée.

Dans tous les cas, il faudra suivre les recommandations du fabricant.

Am häufigsten wird Porenfülllack mit Satin-Finish verwendet. Bitte beachten Sie dabei stets die Hinweise des Herstellers.

La più utilizzata è la vernice riempitiva a poro con finitura satinata. In tutti i casi, seguire sempre le raccomandazioni del fabbricante.





REF.19103

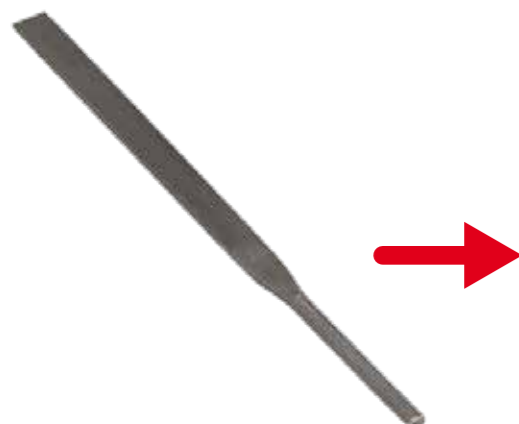
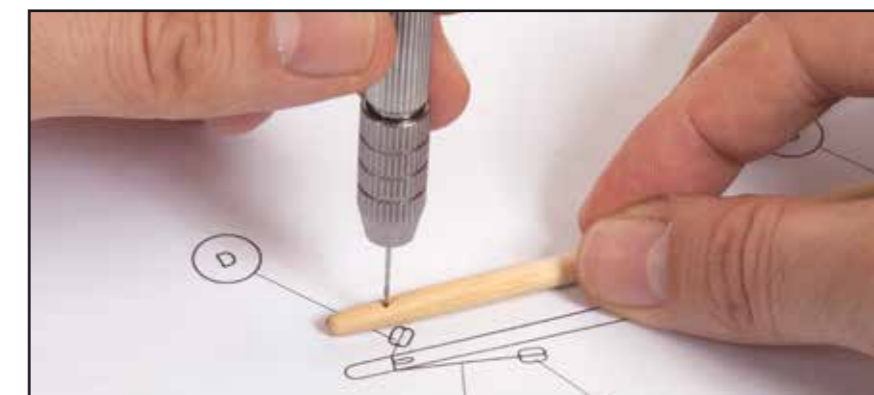
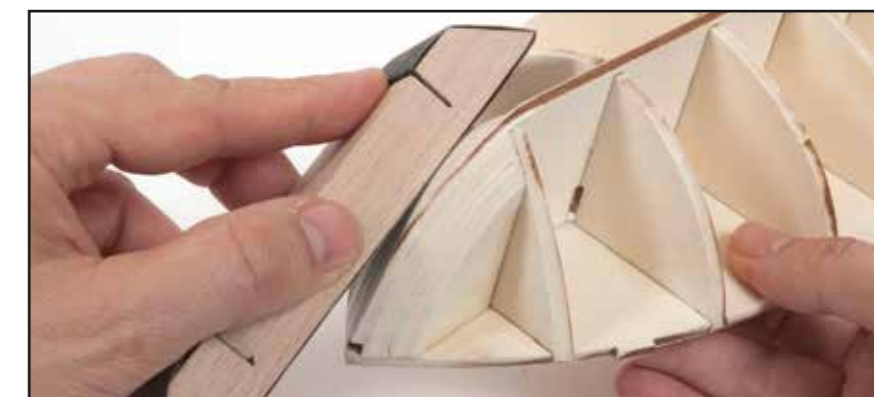
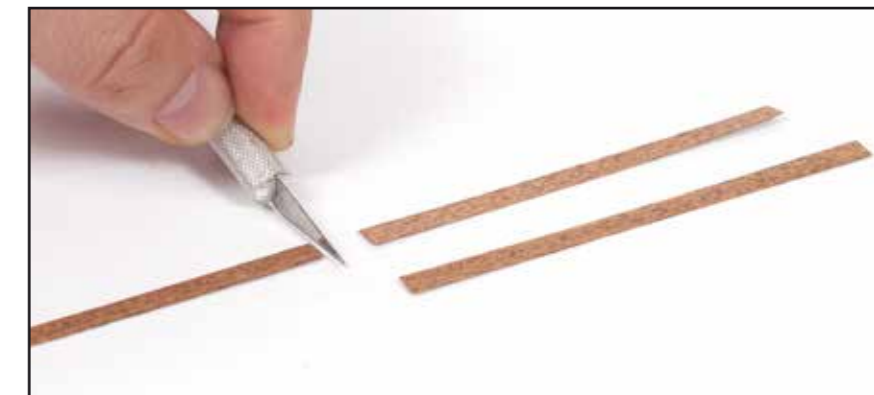

A- Utilice un cúter para cortar los nervios que unen las piezas a las planchas, y así poder extraerlas sin dañarlas. Después, lije las piezas levemente con papel de lija de grano medio, para eliminar el posible repelo de la madera y los restos de los nervios de unión. Siguiendo el orden alfanumérico, inserte y pegue las piezas indicadas en las imágenes. Antes de encolar las cuadernas, A2 a A11, verifique que encajan correctamente en su posición haciendo “tope” en los encajes correspondientes de la falsa quilla, A1. Es importante que las cuadernas queden completamente perpendiculares a la falsa quilla para que posteriormente la cubierta encaje bien. Para esta operación utilice como adhesivo cola blanca. Mantenga las piezas inmovilizadas hasta que el adhesivo se seque.

B- Utilice un lápiz y una regla para hallar el centro de la cubierta, B1, y trace una línea longitudinal sobre ella, que la divida en dos mitades simétricas. Agrupe unas 24 chapas, B2, haciendo coincidir sus perfiles, e inmovilícelas con unas pinzas. Utilice un lápiz para destacar los perfiles de las chapas. Tome un poco de cinta de carroceros, (cinta de pintor), y colóquela sobre un trozo de madera o similar, con la cara adhesiva orientada hacia el exterior. Después, sitúe las chapas sobre la cinta adhesiva de manera que queden muy juntas. Utilice una espátula para aplicar una capa fina y homogénea de cola de contacto sobre las chapas B2. Inmediatamente después, separe las chapas una a una y resérvelas con la cara adhesiva orientada hacia arriba. Debe aplicar también una capa de cola de contacto sobre una mitad de la cubierta B1. Cuando la cola ya no enganche al contacto con los dedos, será el momento de comenzar a forrar la cubierta. Coloque las chapas B2, una a una sobre la cubierta encolada y presione para que se peguen. Utilice el mango de madera de alguna herramienta para frotar con firmeza las chapas y conseguir así que se fijen bien. Forre el resto de la cubierta hasta completarla. Después, sitúela con las chapas orientadas hacia abajo y con un cúter, corte los sobrantes que sobresalen de su contorno. No corte las chapas de los rebajes de la cubierta, observe la imagen 18 para apreciar como debe quedar la cubierta. Utilice un cúter y después una lima redonda, para reabrir los orificios del centro de la cubierta. Lije toda la superficie de la cubierta con un taco lijador. Para simular la tablazón de la cubierta, debe trazar líneas perpendiculares a las chapas. Comience trazando las líneas cada 60 mm alternando las chapas. Después, trace líneas cada 30 mm en las chapas alternas. Marque con el lápiz dos puntos a cada lado de las líneas transversales para simular el claveteado. Aplique barniz nitro tapaporos incoloro con acabado satinado a toda la superficie de la cubierta. Lije la parte superior de la última cuaderna para facilitar el apoyo de la cubierta. Aplique cola blanca, para pegar la cubierta. Para ayudar a inmovilizar la cubierta puede aplicar también pegamento rápido. Asegúrese de que los salientes superiores de las cuadernas encajan en los rebajes de la cubierta.

C- Pegue los refuerzos C1 a C4 a ambos lados de la falsa quilla. Coloque el casco boca abajo y comience a lijar empezando desde proa y avanzando hacia popa. Debe desbastar los refuerzos y las aristas de las cuadernas pero sin deformar su perfil original. El lijado del casco ha de quedar simétrico, es decir, que el lateral derecho ha de quedar igual que el izquierdo. El lijado debe realizarse en todo el casco y debe ser progresivo y suave. Compruebe con un listón, que el lijado es correcto. Para ello, debe deslizar el listón, sobre las cuadernas, para ver como se ajusta a su forma y que apoyo tiene el listón sobre las cuadernas. Sumerja la pieza C5 en agua durante unos 15 minutos para que recupere flexibilidad. Elimine el exceso de agua con un papel secante. Inmediatamente después, utilice algún objeto cilíndrico de diámetro aproximado de 10 cm, para curvar levemente la pieza. Sitúe la pieza C5 sobre el objeto y presiónela con los dedos muy juntos para no romperla. Observe que solamente debe curvarse la parte delantera de la pieza. Después, aplique pegamento rápido y pegue una pieza C5 en el lateral del casco. Proceda de la misma manera para pegar una pieza C5 en el otro lateral del casco. Ajuste y pegue la pieza C6 en la parte trasera del casco.

D-E-F- Sumerja en agua un par de listones D1 para que recuperen flexibilidad. Presente uno de ellos en el lateral del casco para apreciar su recorrido y su ajuste. Aplique cola en las cuadernas justo por debajo de las amuradas. Coloque el listón y clávelo con las puntas A. Para esta operación puede utilizar un clavador, o un martillo. Será necesario clavar una punta A en las zonas donde el listón se cruza con una cuaderna. Una vez clavado el listón a lo largo del casco, deberá cortar el sobrante del mismo por delante y por detrás. Debe ir pegando y clavando listones a ambos lados del casco para conseguir un acabado simétrico. Es importante que pegue los listones también entre sí. A medida que avance con el forrado del casco, encontrará zonas donde el listón no curva bien y será en ese punto donde deberá cortarlo a medida. Pegue los listones lo más juntos posible para conseguir una buena cobertura. Avance el forrado del casco desde la parte inferior de las amuradas hasta la parte inferior de la falsa quilla y al revés. A medida que el forro del casco se va cerrando se formarán espacios con forma de cuña. Elabore estas cuñas cortando listones F1 y dándoles forma con un lijador. Después, péguelos para cerrar el casco. Forre también la parte trasera del casco y lijela para dejarla ajustada a la última cuaderna.

G-H-I- Utilice lijadores para lijar el forro del casco y unificar así su superficie. Utilice una lima para limar las cabezas de las puntas. Compruebe el ajuste de la pieza J1 en la parte delantera del casco y apreciar así el lijado que debe hacer. Corte tiras de chapas G1 y G2 y forre con ellas la parte trasera del casco. Corte los sobrantes con un cúter. Aplique cola de contacto a las chapas G3 y a la zona del casco que le muestran las imágenes. Comience el forrado pegando la primera tira G3 ajustada bajo la amurada. Recuerde que debe ir pegando chapas a ambos lados del casco para conseguir un acabado simétrico. Después, siga pegando chapas H1 por la parte inferior del casco. Complete el forro del casco como hizo con el primer forro, cerrando los huecos con cuñas realizadas a medida. Es importante que las chapas queden muy juntas y que las frote para conseguir un buen acabado. Proceda de la misma manera para forrar la parte superior del casco con las chapas i1. Lije toda la superficie del casco para dejarlo fino. Tenga precaución, pues las chapas son muy finas. Utilice papel de lija medio para redondear las aristas de dos listones i3. Téñalos de color nogal y péguelos uno a cada lado del barco, a 20 mm del perfil superior del casco.

J- Presente las piezas J1 a J5 en el casco para apreciar su ajuste. Retóquelas si fuera necesario. Después, péguelas centradas sobre la falsa quilla del casco. Bisele y tiña las piezas J6 y péguelas en el frontal del casco. Barnice todas las superficies del casco. Utilice cinta de carroceros para proteger la cubierta y pinte de color blanco el interior de las amuradas y de la popa. Después, retire la cinta de carroceros. Pegue las piezas J7 centradas con los orificios de la cubierta. Ajuste y tiña las piezas J8 a J10 de color Nogal y péguelas en la cubierta contra las amuradas. Elabore y tiña de color Nogal las piezas J11 y péguelas como le muestran las imágenes. Bisele con una lima la parte superior de las piezas J11.

K- Lije y tiña las piezas K1 a K5 de color Sapeli. Después pegue las piezas en el casco y barnícelas. Redondee las piezas K6 y K7 con papel de lija y retoque de color Nogal. Pegue las piezas K6 y K7, y después, aplíqueles barniz tapaporos. De forma a la pieza K8 con una varilla y péguela al conjunto. Utilice unos alicates de corte para ajustar la longitud de las bisagras K9 y las puntas K10 que lo necesiten. Pegue y clave las bisagras con las puntas a la pieza K6. Utilice algún objeto plano para enderezar el hilo de latón K11. Para ello, haga rodar el hilo bajo el objeto plano. Elabore y pegue los ejes K11 en las bisagras del timón.

L- Realice el orificio para el timón y retóquelo con una lima redonda o similar. Presente el timón en el casco para comprobar su ajuste y calcular la posición de las bisagras L1. Fije las bisagras L1 con pegamento y puntas L2. Inserte y pegue las piezas L3. Utilice un lápiz para dibujar más o menos la figura que muestran las imágenes en el lateral del casco, y péguele encima cinta de carroceros. Corte la cinta de carroceros con un cúter y retire la parte que muestra la imagen. De esta manera tendrá una máscara para poder pintar con comodidad. Aplique pintura de color negro satinado y cuando se seque, retire la cinta de carroceros.

M-N- Utilice la plantilla PL-01 para elaborar las decoraciones M1 a M3. Doble y corte el hilo de latón con unos alicates. Después péguelas en el barco. Inserte y pegue entre sí las piezas M4 y M5. Barnice y decore los barriles M6. Tiña los soportes M7 de color Sapeli y péguelos a dos de los barriles. Elabore las piezas M8 y fíjeles los ejes M9. Pinte las piezas M14 de color negro satinado y tiña las piezas M15 de color Sapeli. Pegue las piezas en el barco tomando las distancias de la plantilla PL-01. Anude un hilo M11 alrededor de un motón M10. Inserte un cáncamo M12 y cierre el nudo. Aplique un poco de pegamento y corte el sobrante del hilo. Utilice unos alicates para abrir y cerrar las anillas M13, e insertarlas en las argolla de los cáncamos M12. Realice orificios en cubierta para insertar y pegar los cáncamos M12. Tiña las chapas N1 de color Pino y córtelas a medida. Forre las piezas N2. Construya la escotilla con las piezas N2 a N4. Barnice la escotilla y añádale las piezas N5 y N6. Decore la bomba de achique N7 y añádale las piezas N5 y N8. Pegue la escotilla y la bomba de achique en la cubierta.

O- Construya el tambucho con las piezas O1 a O4 y fórralo con las chapas O5. Tiña un listón de color Sapeli y elabore y con él las piezas O7 a O11. De otro listón elabore y pegue las piezas O12. Después, barnice el todo el tambucho. Forre las piezas O13 y O14 con el forro O15. Corte a medida dos piezas O16 para las puertas. Barnice las tres puertas obtenidas. Elabora y pegue la pieza O17 y O18 y péguelas. Pegue las puertas en el tambucho y la chimenea O19 pintada previamente de color negro. Pegue el tambucho en la cubierta.

P- Para elaborar los cadenotes P1, corte ocho porciones de hilo de 50 mm. Adapte una pieza P1 alrededor de una vigota P2 y cruce los extremos del hilo. Utilice unos alicates para trenzar el hilo un par de vueltas. Después, corte uno de los extremos del hilo y enderece el otro. Elabore una argolla en el extremo de la pieza P1. Pegue la pieza P1 en el casco como le muestra la imagen y clávela con una punta P3. Siga los mismos pasos para elaborar y colocar ocho cadenotes. Inserte y fije los cáncamos y motones que le indican las imágenes.

Q- Inserte y pegue las piezas Q1 y Q2. Después, pinta los conjuntos de color negro satinado y detalla los relieves de color oro. Inserta y fija un hilo Q4 con una anilla Q3. Refuerza la unión con un hilo Q5. Inserta el hilo Q4 por el orificio del casco y anúdalo como te muestra la imagen. Después, corta el sobrante.

ARBOLADURA

Para elaborar los mástiles, el primer paso a seguir será cortar las varillas según las medidas que indica la lista de piezas, o bien tomarlas directamente de los planos que están impresos a escala 1/1.

Todos los mástiles y vergas tienen cierta conicidad que se deberá realizar.

Para realizar la conicidad a los mástiles, lije las varillas, (con un lijador), aumentando el desgaste de ésta a medida que se acerca al extremo donde se quiere disminuir el diámetro. Haga rodar la varilla para que el desgaste sea igual por todo el contorno hasta conseguir llegar al diámetro que indica el plano.

Para elaborar la conicidad de las vergas, realice las mismas operaciones, pero esta vez a ambos extremos de la varilla.

Deberá teñir o pintar las varillas en función del modelo que esté construyendo.

Para realizar correctamente los mástiles de este modelo se deberá tener en cuenta:

Los planos

Las fotos de detalle de los mástiles

Las medidas y descripción de materiales de la lista de piezas

Las hojas “IP” de identificación de piezas

La plantilla PL-01

Los mástiles se deberán barnizar y algunas de las piezas que los componen se deberán pintar. Véanse las fotos generales de detalle de los mástiles.

Una vez montados y barnizados, deberán colocarles los aparejos, (estrobos, cuadernales, cáncamos, motones, etc.), y fijarlos al barco. Los mástiles se deben introducir hasta hacer tope en los encajes de la falsa quilla.

JARCIA

Para elaborar la jarcia de este barco, siga el orden alfabético de las figuras impresas de los planos, que indican el orden de colocación: de hilos, vigotas, motones, velas, etc, destacados en color rojo. La lista de piezas le orientará sobre el tipo de materiales y medidas a utilizar.

Para simular el envejecido de las velas, se les puede dar un baño con infusión de té, sin hacerlas hervir, y dejarlas secar bien arrugadas. Se colocaran sin planchar para que tengan cuerpo.

SERVICIO DE ATENCIÓN AL CLIENTE

Para cualquier duda o información sobre el montaje de nuestros productos, puede contactar con nuestro **Servicio Técnico** en la dirección **www.occre.com**. Le atenderemos con mucho gusto.

A- Utiliser un cutter pour couper les nerfs qui unissent les pièces aux planches de sorte à pouvoir les retirer sans les abîmer. Ensuite, poncer légèrement les pièces avec du papier de verre à grain moyen afin d'éliminer la fibre éventuelle du bois et les restes des nerfs d'union. Introduire et coller les pièces indiquées sur les figures en suivant l'ordre alphanumérique. Avant de coller les couples A2 à A11, vérifier qu'ils s'emboîtent correctement à leur place et qu'ils pénètrent à fond dans les emboîtures de la fausse quille A1. Il est important que les couples soient parfaitement perpendiculaires à la fausse quille afin que le pont s'emboîte correctement par la suite. Utiliser de la colle blanche pour réaliser cette opération. Maintenir les pièces immobilisées jusqu'à ce que la colle sèche.

B- Utiliser un crayon et une règle pour définir le centre du pont B1, et tracer une ligne longitudinale sur ce dernier qui le divise en deux moitiés symétriques. Regrouper 24 plaques de bordage B2 en faisant coïncider leur profil et immobiliser ces pièces avec des pinces. Faire ressortir ensuite les profils des plaques à l'aide d'un crayon. Prendre un peu de ruban de carrossier (ruban de peintre) et le placer sur un morceau de bois ou une matière semblable, en plaçant la face adhésive vers l'extérieur. Ensuite, placer les plaques sur le ruban adhésif en veillant à ce qu'elles soient bien serrées les unes contre les autres. Utiliser une spatule pour appliquer une couche fine et homogène de colle de contact sur les plaques B2. Immédiatement après, séparer les plaques une par une et les mettre de côté en plaçant leur face adhésive vers le haut. Il faut également appliquer une couche de colle de contact sur une moitié du pont B1. Lorsque la colle n'accroche plus au contact des doigts, ce sera le moment de commencer à border le pont. Placer les plaques B2, une à la fois, sur le pont collé et appuyer sur les pièces pour qu'elles collent. Utiliser le manche en bois d'un outil pour frotter fermement les plaques et s'assurer qu'elles sont bien fixées. Border le reste du pont. Ensuite, placer le pont avec les plaques orientées vers le bas et couper à l'aide d'un cutter les parties qui dépassent du contour. Ne pas couper les plaques des encoches du pont. Regarder la figure 18 pour voir l'aspect que doit prendre le pont. Utiliser un cutter, puis une lime ronde pour rouvrir les orifices du centre du pont.

Poncer toute la surface du pont avec une cale à poncer. Pour simuler le bordage du pont, tracer des lignes perpendiculaires aux plaques. Commencer par tracer des lignes tous les 60 mm sur une plaque sur deux. Ensuite, tracer des lignes tous les 30 mm sur les autres plaques. Marquer au crayon deux points de chaque côté des lignes transversales pour simuler le cloutage. Appliquer du vernis nitro bouche-pores incolore, finition satinée, sur toute la surface du pont. Poncer la partie supérieure du dernier couple pour faciliter l'appui du pont. Appliquer de la colle blanche pour coller le pont. On peut également appliquer de la colle rapide pour aider à immobiliser le pont. On s'assurera que les tenons supérieurs des couples s'emboîtent dans les encoches du pont.

C- Coller les renforts C1 à C4 de chaque côté de la fausse quille. Retourner la coque et la poncer en allant de la proue vers la poupe. Il faut dégrossir les renforts et les arêtes des couples, mais en veillant à ne pas déformer leur profil original. Le ponçage de la coque doit être symétrique, c'est-à-dire que le côté droit doit être identique au côté gauche. Le ponçage doit être réalisé sur tout le pont ; il doit être progressif et doux. Vérifier à l'aide d'un listeau que le ponçage est correct. À cet effet, faire glisser le listeau sur les couples afin de voir s'il s'adapte bien à leur forme et afin de vérifier l'appui du listeau sur les couples. Plonger la pièce C5 dans l'eau pendant environ 15 minutes afin qu'elle récupère sa flexibilité. Éliminer l'excédent d'eau à l'aide d'un papier buvard. Immédiatement après, utiliser un objet cylindrique de 10 cm environ de diamètre pour courber légèrement la pièce. Placer la pièce C5 sur l'objet et la presser avec les doigts serrés les uns contre les autres pour ne pas la casser. Il faut remarquer que seule la partie avant de la pièce doit être courbée. Appliquer ensuite de la colle rapide et coller une pièce C5 sur le côté de la coque. Procéder de la même manière pour coller une pièce C5 sur l'autre côté de la coque. Ajuster et coller la pièce C6 à l'arrière de la coque.

D-E-F- Plonger deux listeaux D1 dans l'eau afin qu'ils récupèrent leur flexibilité. Placer un de ces listeaux sur le côté de la coque pour voir sa position et son adaptation à la coque. Appliquer de la colle sur les couples juste au-dessous des murailles. Placer le listeau et le clouer à l'aide des pointes A. On peut utiliser un cloueur ou un marteau pour réaliser cette opération. Il faudra clouer une pointe A aux endroits où le listeau croise un couple. Une fois le listeau cloué tout le long de la coque, il faudra couper l'excédent à l'avant et à l'arrière. Il faut coller et clouer des listeaux de chaque côté de la coque afin d'obtenir une finition symétrique. Il est important de coller également les listeaux entre eux. Au fur et à mesure que le bordage de la coque avancera, on trouvera des endroits où les listeaux ne seront pas bien courbés. C'est à ces endroits qu'il faudra les découper sur mesure. Coller les listeaux les plus serrés possible pour obtenir une bonne courbure. Réaliser le bordage de la coque à partir de la partie inférieure des murailles jusqu'à la partie inférieure de la fausse quille et retour. Des espaces en forme de coins se formeront au fur et à mesure que le bordage de la coque se fermera. Réaliser ces coins en coupant des listeaux F1 et donner la forme voulue à ces pièces à l'aide d'une cale à poncer. Ensuite, coller ces pièces pour fermer la coque. Border également la partie arrière de la coque et la poncer pour l'ajuster sur le dernier couple.

G-H-I- Utiliser des taquets de ponçage pour poncer le bordé de la coque et pour uniformiser ainsi sa surface. Utiliser une lime pour limer les têtes des pointes. Vérifier l'ajustement de la pièce J1 à l'avant de la coque et observer le ponçage à obtenir. Découper des lattes de bordage G1 et G2 et border avec celles-ci la partie arrière de la coque. Couper les excédents à l'aide d'un cutter. Appliquer de la colle de contact sur les lattes G3 et sur la zone de la coque indiquée sur les figures. Commencer le bordage en collant la première latte G3 bien ajustée sous la muraille. Ne pas oublier qu'il faut coller des lattes de chaque côté de la coque afin d'obtenir une finition symétrique. Ensuite, continuer de coller des lattes H1 sur la partie inférieure de la coque. Terminer de border la coque comme pour le premier bordage en comblant les espaces à l'aide de coins fabriqués sur mesure. Il est important que les lattes soient bien serrées les unes contre les autres et de les frotter pour obtenir une bonne finition. Procéder de la même manière pour border la partie supérieure de la coque avec les lattes i1. Poncer toute la surface de la coque pour obtenir une finition fine. Il faut faire attention en réalisant cette opération car ces lattes sont très fines. Utiliser du papier de verre à grain moyen pour arrondir les arêtes de deux listeaux i3. Teindre ces lattes en couleur noyer et les coller une de chaque côté du bateau, à 20 mm du profil supérieur de la coque.

J- Placer les pièces J1 à J5 sur la coque pour voir la position qu'elles devront avoir. Retoucher ces pièces si c'est nécessaire. Ensuite, coller ces pièces bien centrées sur la fausse quille de la coque. Biseauter et teindre ces pièces J6, puis les coller sur l'avant de la coque. Vernir toutes les surfaces de la coque. Utiliser du ruban de carrossier pour protéger le pont et peindre en blanc l'intérieur des murailles et de la poupe. Ensuite, retirer le ruban de carrossier. Coller les pièces J7 bien centrées sur les orifices du pont. Ajuster et teindre les pièces J8 à J10 en couleur Noyer et les coller sur le pont contre les murailles. Réaliser et teindre en couleur Noyer les pièces J11, puis les coller comme sur les figures. Biseauter la partie supérieure des pièces J11 à l'aide d'une lime.

K- Poncer et teindre les pièces K1 à K5 en couleur Sapelli. Ensuite, coller les pièces sur la coque, puis les vernir. Arrondir les pièces K6 et K7 avec du papier de verre et retoucher celles-ci en couleur noyer. Coller les pièces K6 et K7, puis appliquer du vernis bouche-pores. Donner de la forme à la pièce K8 avec une tige, puis coller la pièce sur l'ensemble. Utiliser une pince à couper pour ajuster la longueur des charnières K9 et les pointes K10, si c'est nécessaire. Coller et clouer les charnières avec les pointes sur la pièce K6. Utiliser un objet plat pour redresser le fil de laiton K11. À cet effet, faire rouler le fil sous l'objet plat. Confectionner et coller les axes K11 sur les charnières du gouvernail.

L- Percer l'orifice pour le gouvernail et retoucher avec une lime ronde ou semblable. Placer le gouvernail sur la coque pour vérifier sa disposition et calculer la position des charnières L1. Fixer les charnières L1 avec de la colle et des pointes L12. Insérer et coller les pièces L13. Utiliser un crayon pour dessiner de façon approximative la figure montrée sur les photos sur le flanc de la coque, puis coller dessus du ruban de carrossier. Couper le ruban de carrossier à l'aide d'un cutter et retirer la partie montrée sur la photo. On aura ainsi un masque qui permettra de peindre de façon optimale. Appliquer de la peinture de couleur noire satinée et, quand elle est sèche, retirer le ruban de carrossier.

M-N- Utiliser le patron PL-01 pour confectionner les décorations M1 à M3. Plier et couper le fil de laiton avec une pince. Ensuite, coller ces pièces sur le bateau. Introduire et coller ensemble les pièces M4 et M5. Vernir et décorer les tonneaux M6. Teindre les supports M7 de couleur Sapelli, puis les coller sur deux tonneaux. Confectionner les pièces M8 et fixer les axes M9 sur ces pièces. Peindre les pièces M14 en noir satiné et teindre les pièces M15 en couleur Sapelli. Coller les pièces sur le bateau en prenant les distances sur le patron PL-01. Nouer un fil M11 autour d'une poulie M10. Introduire un piton M12 et faire le nœud. Appliquer un peu de colle et couper l'excédent de fil. Utiliser une pince pour ouvrir et fermer les anneaux M13 et les introduire dans l'ouverture des pitons M12. Percer des orifices sur le pont pour introduire et coller les pitons M12. Teindre les plaques N1 en couleur pin et les couper sur mesure. Border les pièces N2. Construire l'écouille avec les pièces N2 à N4. Vernir l'écouille et y ajouter les pièces N5 et N6. Décorer la pompe d'assèchement N7 et y ajouter les pièces N5 et N8. Coller l'écouille et la pompe d'assèchement sur le pont.

O- Construire le rouf avec les pièces O1 à O4 et le border avec les plaques O5. Teindre un listeau en couleur Sapelli et confectionner avec ce listeau les pièces O7 à O11. Confectionner et coller les pièces O12 à partir d'un autre listeau. Ensuite, vernir tout le rouf. Recouvrir les pièces O13 et O14 avec le bordé O15. Découper sur mesure deux pièces O16 pour les portes. Vernir les trois portes obtenues. Confectionner et coller les pièces O17 et O18. Coller les portes sur le rouf et la cheminée O19 qui aura été peinte au préalable en noir. Coller le rouf sur le pont.

P- Pour fabriquer les cadènes P1, couper huit morceaux de fil de 50 mm. Faire passer une pièce P1 autour d'un cap de mouton P2 et croiser les extrémités du fil. Utiliser une pince pour tordre deux fois le fil. Ensuite, couper une des extrémités du fil et redresser l'autre extrémité. Faire un anneau à l'extrémité de la pièce P1. Coller la pièce P1 sur la coque comme le montre la figure, puis la clouer avec une pointe P3. Procéder de la même manière pour confectionner et placer huit cadènes. Introduire et fixer les autres pitons et poulies qui sont indiqués sur les figures.

Q- Introduire et coller les pièces Q1 et Q2. Ensuite, coller les ensembles en noir satiné et faire ressortir les reliefs en couleur dorée. Introduire et fixer un fil Q4 avec un anneau Q3. Renforcer l'union avec un fil Q5. Introduire le fil Q4 dans l'orifice de la coque et le nouer comme sur la figure. Ensuite, couper l'excédent.

MÂTURE

La première chose à faire pour confectionner les mâts est de couper les baguettes aux dimensions indiquées dans la liste des pièces ou de prendre ces mesures directement des plans qui sont imprimés à l'échelle 1/1.

Tous les mâts et les vergues possèdent une certaine conicité qui doit être travaillée.

Pour réaliser la conicité des mâts, poncer les baguettes (avec une ponceuse) en augmentant le dégrossissage au fur et à mesure qu'on s'approche de l'extrémité où l'on souhaite diminuer le diamètre. Faire rouler la baguette afin que l'usure soit égale sur tout le contour jusqu'à ce qu'on obtienne le diamètre indiqué sur le plan.

Effectuer les mêmes opérations pour réaliser la conicité des vergues mais, dans ce cas, aux deux extrémités de la baguette.

Il faudra teinter ou peindre les baguettes en fonction de la maquette qui sera construite.

Pour réaliser correctement les mâts de cette maquette, il faudra tenir compte :

Des plans. Des photos de détail des mâts. Des dimensions et de la description des matériaux de la liste des pièces. Des feuilles « IP » d'identification des pièces. Le patron PL-01

Les mâts devront être vernis et certaines des pièces qui les composent devront être peintes. Voir les photos générales de détail des mâts. Lorsque les mâts seront montés et vernis, on placera leurs apparaux (estropes, moufles, pitons, poulies, etc.) et on les attachera au bateau. Les mâts doivent être introduits de sorte qu'ils s'emboîtent à fond contre la fausse quille.

GRÉEMENT

Pour réaliser le gréement de ce bateau, on suivra l'ordre alphabétique des figures imprimées des plans, qui indiquent l'ordre de montage (fils, caps de mouton, poulies, etc.) mis en évidence en rouge. La liste des pièces indique le type de matériaux et les dimensions à utiliser. Pour simuler le vieillissement des voiles, on peut les faire tremper dans une infusion de thé, sans les faire bouillir, et les laisser sécher bien chiffonnées. Les voiles seront placées non repassées afin d'avoir du volume.

SERVICE CLIENT

Pour toute question ou information concernant le montage de nos produits,
vous pouvez contacter notre Service technique

à l'adresse suivante: www.occre.com. Nous répondrons avec plaisir à vos questions.

A- Use a cutter to cut the tabs that join the pieces to the templates, so they can be removed without damaging them. Then sand the pieces lightly with medium grain sandpaper to remove any snags on the wood and any remains of the tabs. Following the alphanumeric order, insert and glue the pieces indicated in the images. Before gluing the ribs as shown in A2 to A11, check they fit correctly by inserting them until the "stop" in the corresponding slits of the false keel, A1. It's important the ribs are completely perpendicular to the false keel to ensure the deck fits properly afterwards. Use white glue as an adhesive for this operation. Keep the parts immobilised until the adhesive dries.

B- Use a pencil and ruler to find the centre of the deck, B1, and draw a longitudinal line on it, dividing it into two symmetrical halves. Assemble about 24 strips, B2, ensuring their profiles match, and immobilise them with pegs. Use a pencil to highlight the profiles of the strips. Place some masking tape (painter's tape) on a piece of wood or similar, with the adhesive side facing outwards. Then place the strips on the adhesive tape so they're very close together. Use a spatula to apply a thin, even layer of contact glue to the B2 strips. Immediately afterwards, separate the strips one by one and put them to one side, with the adhesive side facing upwards. You must also apply a layer of contact glue on one half of the B1 deck. When the glue is no longer sticky to touch, it's time to start lining the deck. Place the B2 strips, one by one, on the glued deck and press them into place. Use the wooden handle of a tool to press down the strips firmly and ensure they're securely fastened. Line the rest of the deck until it's complete. Then position the deck with the strips facing downwards and, using a cutter, cut off any excess protruding from its edge. Don't cut the strips at the deck rabbets; see picture 18 to see what the deck should look like. Use a cutter and then a round file to reopen the holes in the centre of the deck. Sand the entire surface of the deck with a sanding block. To simulate the deck boarding, you must draw lines perpendicular to the strips. Start by drawing the lines every 60 mm, alternating the strips. Then draw lines every 30 mm on the alternate strips. Use the pencil to mark two points on each side of the transversal lines to simulate nailing. Prime the entire surface of the deck with colourless satin-finish nitro varnish. Sand the top of the last rib to ensure the deck is well supported. Apply white glue to the deck. To help immobilise the deck, you can also apply instant glue. Make sure the top projections of the ribs fit into the slits in the deck.

C- Glue the reinforcements C1 to C4 to both sides of the false keel. Turn the hull upside-down and start sanding from the bow, working your way towards the stern. You should roughen the reinforcements and the edges of the ribs but without altering their original profile. The sanding of the hull must be symmetrical; i.e. the right side must be the same as the left side. Sanding should be done on the entire hull and should be progressive and smooth. Check with a stick that the sanding is correct. To do so, you should slide the stick over the ribs to check how it adjusts to their shape and how the batten rests on the ribs. Soak a C5 part in water for about 15 minutes to restore flexibility. Remove any excess water with blotting paper. Immediately afterwards, use a cylindrical object of approximately 10 cm diameter to slightly bend the piece. Place the C5 on the object and press with your fingers very close together so as not to break it. Note that only the front of the part should be bent. Next, apply instant glue and attach the C5 to the side of the hull. Use the same method to glue another C5 to the other side of the hull. Fit and glue the C6 to the back of the hull.

D-E-F- Soak a pair of D1 sticks in water to restore flexibility. Check the length and adjustment by comparing one of them with the side of the hull. Apply glue to the ribs just below the bulwarks. Position the strip and nail it in place using the tacks. For this operation you can use a nailer or a hammer. A tack will need to be inserted at those points where the strip crosses a rib. Once the strip has been nailed down along the hull, you should cut off any excess from the front and back. You should glue and nail strips to both sides of the hull to achieve a symmetrical finish. It's important to also glue the strips together. As you proceed with the hull lining, you'll find areas where the strip doesn't bend well; this where you'll need to cut it to size. Glue the strips as close together as possible to get good coverage. Place the hull lining from the bottom of the bulwarks to the bottom of the false keel and vice versa. As the hull lining is completed, wedge-shaped spaces will appear. Make these wedges by cutting F1 strips and shaping them with a sander. Then glue them to complete the hull. Also line the back of the hull and sand it down to fit the last rib.

G-H-I- Use sanders to sand the hull lining to make the surface even. Use a file for the heads of the tacks. Check the fit of part J1 on the front of the hull and thereby check whether any sanding is required. Cut strips of G1 and G2 and use them to line the back of the hull. Remove any excess with a cutter. Apply contact glue to the G3 strips and to the area of the hull shown in the pictures. Begin the lining by gluing the first G3 strip just below the bulwark. Remember to glue strips on both sides of the hull to achieve a symmetrical finish. Then continue to glue H1 strips to the underside of the hull. Complete the hull lining as you did with the first lining, filling any gaps with custom-made wedges. It's important that the strips are positioned very close together and that you file them to get a good finish. Proceed in the same way to line the top of the hull with the i1 strips. Sand the entire surface of the hull to make it smooth. Be careful, as the strips are very thin. Use medium sandpaper to round the edges of two i3 strips. Stain them walnut colour and glue them, one on each side of the boat, 20 mm from the upper edge of the hull.

J- Check parts J1 to J5 with the hull to ensure they fit. Adjust them if necessary. Then glue them in the centre of the false keel of the hull. File and stain the J6 parts and glue them to the front of the hull. Varnish all hull surfaces. Use masking tape to protect the deck then paint the inside of the bulwarks and the stern white. Remove the masking tape. Glue the J7 parts, centred with the holes of the deck. Adjust and stain the parts J8 to J10 a Walnut wood colour and glue them on the deck against the bulwarks. Make and stain the J11 parts a Walnut wood colour then glue them as shown in the pictures. File the top of the J11 parts.

K- Sand and then stain the parts K1 to K5 a Sapele wood colour. Then glue the pieces to the hull and varnish them. Round off parts K6 and K7 with sandpaper and retouch in walnut. Glue the parts K6 and K7, then apply a primer to them. Shape the K8 part with a rod and attach it to the model. Use cutting pliers to adjust the length of the K9 hinges and K10 tacks as needed. Glue and nail the hinges with the tacks to the K6 part. Use a flat object to straighten the K11 brass wire. To do so, roll out the wire under the flat object. Make and glue the K11 shafts to the rudder hinges.

L- Make the hole for the rudder and finish with a round file or similar. Check the rudder against the hull to make sure it fits and calculate the position of the L1 hinges. Secure the L1 hinges with glue and L2 tacks. Insert and glue the L3 parts. Use a pencil to roughly draw the figure shown in the pictures on the side of the hull, then cover with masking tape. Cut the masking tape with a cutter and remove the part shown in the picture. This way you'll have a mask and can paint comfortably. Apply satin black paint and, when dry, remove the masking tape.

M-N- Use the PL-01 template to make the M1 to M3 decorations. Bend and cut the brass wire with pliers. Then glue them to the boat. Insert and glue M4 and M5 together. Varnish and decorate the M6 barrels. Stain the M7 supports with a Sapele wood colour and glue them to two of the barrels. Make the M8 parts and fix the M9 shafts to them. Paint the M14 parts in satin black and stain the M15 part a Sapele wood colour. Glue the parts onto the boat using the measurements given on the PL-01 template. Knot an M11 thread around an M10 block. Insert an M12 eyebolt and finish the knot. Apply some glue and cut off any excess thread. Use pliers to open and close the M13 rings, and insert them into the M12 eyebolts. Make holes in the deck to insert and glue the M12 eyebolts. Stain the N1 strips a pine wood colour and cut them to size. Line up the N2 parts. Build the hatchway using parts N2 to N4. Paint the hatchway and add the N5 and N6 parts. Decorate the N7 bilge pump and add the N5 and N8 parts. Glue the hatchway and bilge pump to the deck.

O- Construct the deckhouse with parts O1 to O4 and strip it with the O5 strips. Stain a strip Sapele wood colour and use it to make parts O7 to O11. From another strip make and glue the O12 parts. Then varnish the whole deckhouse. Line parts O13 and O14 with the O15 lining. Cut to size two O16 parts for the doors. Varnish the three doors obtained. Make and glue parts O17 and O18 and attach them. Glue the doors onto the deckhouse and the chimney O19, previously painted black. Glue the deckhouse to the deck.

P- To make the P1 chains, cut eight portions of 50 mm wire. Wind a P1 around a P2 deadeye and cross over the ends of the wire. Use a pair of pliers to braid the wire a couple of turns. Then cut one end of the wire and straighten the other. Make a ring on the end of the P1 part. Glue the P1 part onto the hull as shown and attach with a P3 tack. Follow the same steps to make and place eight chains. Insert and fix the eyebolts and blocks as shown in the pictures.

Q- Insert and glue parts Q1 and Q2. Then paint them satin black and with the details in relief in gold. Insert and glue a Q4 thread with a Q3 ring. Reinforce the connection with a Q5 thread. Insert the Q4 thread through the hole in the hull and knot it as shown in the picture. Then remove any excess.

MASTS AND SPARS

In order to make up the masts the first step is to cut the rods to size, as indicated in the parts list, or by taking measurements directly from the plans, which are printed in 1/1 scale.

All of the masts and spars have to have a certain conical shape, which they will have to be given.

In order to achieve this conical shape for the masts, sand down the rod (using a sander), increasing the amount of sanding down as you get closer to the end at which you want to decrease the diameter. Turn the rod so that you sand it down evenly on all sides, until achieving the diameter indicated in the plan.

To achieve this conical shape for the spars carry out the above operations but in this case evenly reducing the diameter at both ends of the rod.

The rods will have to be stained or painted, depending on the model that you are building.

To correctly make up the mast for this model you must take into account:

The plans

The close-up photos of the masts and spars

The measurements and material descriptions of the parts list

The "PI" parts identification sheets

Template PL-01

The masts and spars need to be varnished, while some of the parts that make them up are meant to be painted. Examine the general and close-up photos of the masts

Once the mast and spars has been assembled and varnished fix the tackle (slings, blocks, eyebolts, clump blocks, etc.) into place on the ship. The masts will have to be fully inserted into the sockets prepared to receive them in the false keel.

SAILS AND RIGGING

In order to make up the running gear for this ship follow the alphabetic order of the images printed on the plans, indicating the order for fitting the (ropes, clump blocks, blocks, sails, etc.) highlighted in red. In combination with the parts list this will serve as a guide with regard to the type of material to be used and the measurements.

A method for simulating the aging of the sails is to soak them in an infusion of tea, without boiling, and then leaving them to dry all wrinkled up. Fit them in place without ironing so that they will have a certain consistency.

CUSTOMER ATTENTION SERVICE

Lorem ipsum

In the case of whatsoever doubt or further information that you may require regarding the assembly of our products, please contact our Technical Service online at the address www.occre.com. We will be delighted to attend to you.

A- Die Teile vorsichtig mit einem Schneidewerkzeug (Cutter) herauslösen und die kleinen Befestigungsenden entfernen. Anschließend die mit feinem Schmirgelpapier glätten, um die Reste der Befestigungsenden und eventuelle Holzspäne zu entfernen. Die auf den Abbildungen gezeigten Teile in der angegebenen Reihenfolge einsetzen und aufkleben. Vor dem Aufkleben der Spanten (A2 bis A11) sicherstellen, dass diese korrekt am Anschlag sitzen und mit den dazugehörigen Einkerbungen des falschen Kiels A1 abschließen. Die Spanten müssen vollkommen senkrecht auf dem falschen Kiel die Abdeckung passt, damit die Decks danach gut eingesetzt werden können. Für diesen Schritt weißen Leim verwenden. Die Teile fixieren, bis der Kleber getrocknet ist.

B- Mit Bleistift und Lineal die Mitte des Decks B1 ermitteln und eine Längslinie ziehen, mit der das Deck in zwei symmetrische Hälften geteilt wird. Ein paar 24 Leisten B2 mit gleichem Profilen mit Klammern zusammenstecken. Mit einem Bleistift die Profile der Leisten markieren. Etwas Kreppband mit der Klebeseite nach außen auf ein Stück Holz oder einen ähnlichen Gegenstand legen. Anschließend die Leisten dicht nebeneinander auf das Klebeband setzen. Mit einem Spachtel eine dünne gleichmäßige Schicht Kontaktkleber auf die Leisten B2 verteilen. Unmittelbar anschließend die Leisten voneinander trennen und mit der Klebeseite nach oben beiseite legen. Eine Schicht Kontaktkleber auf eine Hälfte des Decks B1 verteilen. Wenn der Leim nicht mehr an den Fingern kleben bleibt, mit dem Weger des Decks beginnen. Die Leisten B2 nacheinander einzeln auf die mit Leim bestrichene Deckhälfte setzen und andrücken, damit sie haften. Damit sie gut anhaften, die Leisten mit dem Holzstiel eines Werkzeugs andrücken. Das Deck komplett mit Leisten verkleiden. Anschließend das Deck mit der Oberseite nach unten aufsetzen und die überstehenden Teile der Leisten abschneiden. Die Leisten der Aussparungen des Decks nicht abschneiden, auf Abbildung 18 ist zu sehen, wie das Deck aussehen muss. Mit einem Cutter und anschließend einer Rundfeile die Öffnungen an der Deckmitte wieder öffnen.

Die ganze Oberfläche des Decks mit einem Sander glatt schmirgeln. Abschließend senkrechte Linien ziehen, um die Schiffsbeplankung zu simulieren. Die Längslinien alle 60 mm auf jeder zweiten Leiste ziehen. Anschließend auf den Leisten dazwischen alle 30 mm Linien ziehen. Mit einem Bleistift an jeder Seite die Plankennägel simulieren. Die ganze Oberfläche des Decks mit satiniertem farblosem porenschließendem Lack behandeln. Die Oberseite des letzten Spanten glatt schmirgeln, damit das Deck besser sitzt. Weißen Leim auftragen, um das Deck anzukleben. Um das Deck zu immobilisieren, kann auch Sekundenkleber verwendet werden. Die oberen Ende der Spanten müssen in den Aussparungen des Decks sitzen.

C- Die Verstrebungen C1 bis C4 an beiden Seiten des falschen Kiels aufkleben. Den Rumpf mit der Oberseite nach unten anbringen und vom Bug in Richtung Heck glattschmirgeln. Die Verstrebungen und die Kanten der Spanten glätten, aber dabei nicht das ursprüngliche Profil verändern. Beim Glätten des Rumpfs darauf achten, dass beide Seiten symmetrisch zueinander sein müssen. Die ganze Oberfläche des Rumpfs nach und nach vorsichtig glätten. Mit der Leiste testen, ob eine gleichmäßige Oberfläche hergestellt wurde. Dazu die Leiste über die Spanten fahren und prüfen, wie sie sich der Form anpasst und wie die Leiste auf dem Spanten sitzt. Das C5-Teil für ca. 15 Minuten in Wasser einweichen, damit es biegsam wird. Überschüssiges Wasser mit Papiertaschentuch trocknen. Unmittelbar anschließend das Teil vorsichtig mit einem zylinderförmigen Gegenstand (Dm. ca. 10 cm) zurechtbiegen. Teil C5 auf den Zylinder setzen und mit den Fingern vorsichtig andrücken und dabei aufpassen, dass es nicht zerbricht. Darauf achten, dass nur das vordere Ende des Teils gekrümmt werden muss. Anschließend Sekundenkleber auftragen und ein Teil C5 an die Rumpfseite kleben. Auf gleiche Weise mit Teil C5 für die andere Rumpfseite verfahren. Teil C6 anpassen und am hinteren Ende des Rumpfs aufkleben.

D-E-F- Die Leisten D1 in Wasser einweichen, damit sie biegsamer werden. Eine davon an die Rumpfseite halten, um die richtige Passform zu prüfen. Leim auf die Spanten direkt unter der Schanzverkleidung auftragen. Die Leiste anbringen und mit den Stiften A aufnageln. Dazu kann man einen Nagler oder einen Hammer verwenden. Einen Stift A an der Stelle festnageln, an der die Leiste einen Spant kreuzt. Nachdem die Leiste an der gesamten Länge des Rumpfs angenagelt wurde, die überstehenden Enden zu beiden Seite abschneiden. Die Leisten an beiden Seiten des Rumpfs aufkleben und festnageln, damit ein symmetrisches Ganzes entsteht. Die Leisten müssen auch miteinander verklebt werden. Beim Verkleiden des Schiffsrumpfs von oben nach unten gelangt man an eine Stelle, an der sich die Leiste nicht mehr gut krümmen lässt. Ab dieser Höhe müssen die Leisten zurechtgestutzt werden. Die Leisten so nah wie möglich aneinander kleben, damit eine geschlossene Oberfläche entsteht. Von der Unterseite der Schanzverkleidung bis zur Unterseite des falschen Kiels mit dem Verkleiden fortfahren und umgekehrt. Je mehr sich die Rumpfbeplankung schließt, desto mehr treffen keilförmige offene Stellen auf. Die Schlusskeile aus Leisten F1 zurechtschneiden und mit einem Sander in die passende Form bringen. Anschließend ankleben, um den Rumpf zu schließen. Die Rückseite des Rumpfs verkleiden und glatt schmirgeln, so das sie mit dem letzten Spant abschließt.

G-H-I- Die Rumpfbeplankung mit Feilen glatt schmirgeln und eine gleichmäßige Oberfläche herstellen. Mit einer Feile die Köpfe der Stifte glätten. Den korrekten Sitz von Teil J1 an der Vorderseite des Rumpfs prüfen und falls notwendig glatt schmirgeln. Leisten G1 und G2 ausschneiden und damit die Hinterseite des Rumpfs verkleiden. Die überstehenden Teile mit einem Cutter abschneiden. Kontaktkleber auf die Leisten G3 und die auf den Abbildungen gezeigten Stellen des Rumpfs auftragen. Mit der Beplankung mit der Leiste G3 beginnen, die direkt unter der Schanzverkleidung angeklebt wird. Die Leisten an beiden Seiten des Rumpfs aufkleben, damit ein symmetrisches Ganzes entsteht. Anschließend die Leisten H1 an der Unterseite des Rumpfs aufkleben. Die Rumpfbeplankung wie bei der ersten Verkleidung damit abschließen, die Zwischenräume mit nach Maß zurechtgeschnittenen Schlusskeilen zu schließen. Die Leisten eng aneinander kleben und anreiben, damit eine gleichmäßige Oberfläche entsteht. Ebenso vorgehen, um die Oberseite des Rumpfs mit den Leisten I1 zu verkleiden. Die ganze Oberfläche des Rumpfs glatt schmirgeln. Vorsichtig vorgehen, denn die Leisten sind sehr dünn. Die Kanten der beiden Leisten i3 mit mittelfeinem Schmirgelpapier abrunden. In Nussbaumholzfarbe färben und jeweils eine an jeder Seite des Schiffs 20 mm vom oberen Profil des Rumpfs entfernt ankleben.

J- Die Teile J1 bis J5 an den Rumpf halten, um den Sitz zu überprüfen. Falls erforderlich zurechtstutzen. Anschließend zentriert auf den falschen Kiel des Rumpfs kleben. Die Teile J6 abkanten und färben und an den Vorderseite des Rumpfs aufkleben. Alle Oberflächen des Rumpfs lackieren. Das Deck zum Schutz mit Kreppband abkleben und die Innenseite von Schanzverkleidung und Heck weiß lackieren. Anschließend Kreppband entfernen. Die Teile J7 mit den Öffnungen des Decks zentriert aufkleben. Die Teile J8 bis J10 zurechtstutzen und in Wallnuss-Farbe lackieren und auf dem Deck an die Schanzverkleidung kleben. Die Teile J11 anfertigen und in Wallnuss-Farbe lackieren und wie auf den Abbildungen gezeigt aufkleben. Mit einer Feile die Oberseite der Teile J11 abrunden.

K- Die Teile K1 bis K5 glatt schmirgeln und in Sapelly-Holz färben. Anschließend die Teile an den Rumpf kleben und lackieren. Die Teile K6 und K7 mit Schmirgelpapier abrunden und in Nussbaumholzfarbe nachlackieren. Die Teile K6 und K7 aufkleben und anschließend mit Poren schließendem Lack behandeln. Teil K8 mit einem Stab formen und an die Baugruppe kleben. Mit einer Zange die Scharniere K9 und die Stifte K10 wenn nötig auf die passende Länge zurechtschneiden. Die Scharniere mit den Stiften an Teil K6 kleben und festnageln. Einen ebenen Gegenstand verwenden, um den Messingdraht K11 auszurichten. Dazu den Draht um den Gegenstand wickeln. Die Achsen K11 anfertigen und an die Ruderscharniere kleben.

L- Öffnung für das Steuer anbringen und Innenseite mit einer Rundfeile oder einem ähnlichen Werkzeug glätten. Das Steuer an den Rumpf halten, um den richtigen Sitz zu prüfen und die Position der Scharniere L1 zu bestimmen. Scharniere L1 mit Kleber und Stiften L2 befestigen. Die Teile L3 einsetzen und aufkleben. Mit einem Bleistift die auf den Abbildungen gezeigte Figur an der Rumpfseite zeichnen und Kreppband darüber kleben. Kreppband mit einem Cutter einschneiden und das auf der Abbildung gezeigte Stück entfernen. Auf diese Weise erhält man eine Schablone und kann einfacher lackieren. In satiniertem Schwarz lackieren und Kreppband entfernen.

M-N- Mit der Schablone PL-01 die Dekorationen M1 bis M3 anfertigen. Messingdraht mit einer Zange knicken und zurechtschneiden. Anschließend am Schiff aufkleben. Die Teile M4 und M5 einsetzen und aneinander kleben. Die Fässer M6 lackieren und verzieren. Die Stützen M7 in Sapelly-Holz färben an zwei der Fässer kleben. Die Teile M8 anfertigen und an den Achsen M9 befestigen. Die Teile M14 in satiniertem Schwarz lackieren die Teile M15 in Sapelly-Holz färben. Die Teile in den Abständen von Schablone PL-01 am Schiff aufkleben. Draht M11 um eine Blockrolle M10 wickeln. Ösenstift M12 einsetzen und Knoten festzurren. Etwas Kleber aufbringen und überstehende Enden des Drahts aufbringen. Mit einer Zange die Schiffsringe M13 öffnen und schließen und in die Öse der Ösenstifte M12 einsetzen. Öffnungen am Deck anbringen, um die Ösenstifte M12 einzusetzen, danach festkleben. Die Leisten N1 pinienfarben färben und passend zurechtschneiden. Die Teile N2 verkleiden. Die Luke aus den Teilen N2 bis N4 anfertigen. Die Luke lackieren und die Teile N5 und N6 anbringen. Die Lenzpumpe N7 dekorieren und die Teile N5 und N8 anbringen. Luke und Lenzpumpe auf Deck aufkleben.

O- Die Kajütsluke aus den Teilen O1 bis O4 anfertigen und mit den Leisten O5 verkleiden. Eine Leiste in Sapelly-Holz färben und mit den Teilen O7 bis O11 verkleben. Mit einer anderen Leiste die Teile O12 zusammenkleben. Anschließend die ganze Kajütsluke I. Die Teile O13 und O14 mit Beplankung O15 verkleiden. Zwei Teile O16 für die Türen zurechtschneiden. Die drei Türen danach lackieren. Teil O17 und O18 zusammenkleben und aufkleben. Türen an die Kajütsluke kleben und Schornstein O19 schwarz anmalen und aufkleben. Die Kajütsluke auf Deck festkleben.

P- Die Wantleisten P1 aus acht 50-mm-Stücken Draht anfertigen. Teil P1 um Klampbock P2 wickeln und die Enden des Drahts kreuzen. Mit einer Zange den Draht verdrehen. Anschließend ein Ende des Drahts abschneiden und das andere zurechtziehen. Eine Öse am Ende von Teil P1 anfertigen. Teil P1 wie auf der Abbildung gezeigt an den Rumpf kleben und mit einem Stift P3 festnageln. Auf dieselbe Weise acht Wantleisten anfertigen und aufkleben. Die Ösenstifte und Blockrollen, die auf den Abbildungen zu sehen sind, einsetzen und befestigen.

Q- Die Teile Q1 und Q2 einsetzen und festkleben. Anschließend die Baugruppen in satiniertem Schwarz lackieren und die Reliefs goldfarben anmalen. Draht Q4 mit einer Öse Q3 befestigen. Verbindung mit einem Draht Q5 verstärken. Draht Q4 in die Öffnung des Rumpfs einsetzen und wie auf der Abbildung gezeigt verknoten. Anschließend die überstehenden Enden abschneiden.

BEMASTUNG

Zur Herstellung der Masten müssen zuerst die Stäbe entsprechend der Maße zurecht geschnitten werden, die in der Teileliste angegeben sind oder die direkt anhand der Skizze abgemessen wurde. Die Skizzen sind im Maßstab 1/1 angefertigt.

Alle Masten und Rahen müssen leicht konisch verlaufen und vor dem Einbau entsprechen vorbereitet werden.

Um die Masten in Konusform zu bringen, müssen die Masten (mit einer Feile) zurecht geschliffen werden, und zwar in der Form, dass sie nach oben hin verjüngt werden. Die Stäbe dabei drehen und an allen Seiten gleichmäßig abschleifen, bis sie zu dem auf der Skizze angegebenen Durchmesser passen.

Um die Rahen in Konusform zu bringen, ebenso verfahren, allerdings hier an beiden Enden der Stangen.

Die Stäbe in Abhängigkeit von dem Modell färben oder anmalen.

Um die Masten dieses Schiffsbaumodells richtig vorzubereiten, müssen die folgenden Punkte beachtet werden:

Die Skizzen. Detailfotos der Masten. Maße und Materialien der Teileliste. IP-Blätter zur Identifikation der Bauteile. Schablone PL-01

Die Masten müssen lackiert werden und einige der Einzelteile der Masten müssen angemalt werden. Siehe Fotos mit allgemeiner Ansicht der Masten

Nach Aufstellung und Lackierung der Masten wird die Takelung (Stroppe, Rollenblöcke, Ösen, Blockrollen etc.) an den Masten und dann am Schiff befestigt. Die Masten müssen eingesetzt werden, bis sie an die Einkerbungen des falschen Kiels stoßen.

TAKELAGE

Zur Takelung des Schiffsmodells die alphabetische Reihenfolge der Abbildungen befolgen, auf denen die Anbringung der Takelung (Faden, Klampböcke, Blockrollen usw.) erläutert wird. Sie sind in Rot hervorgehoben. Auf der Teileliste sehen Sie, welche Materialien zum Bau des Modells notwendig sind.

Zur künstlichen Alterung der Segel die Stoffstücke in Tee legen (nicht kochen) und trocknen lassen, bis die Stoffe faltig werden. Die Segel ohne vorheriges Bügeln anbringen, damit sie Volumen haben.

UNSER KUNDENDIENST

Bei Fragen zum Aufbau unserer Modelle steht Ihnen unser Kundendienst zur Verfügung.

Sie erreichen uns online unter www.occre.com.

Wir stehen Ihnen gern mit Rat und Tipps zur Verfügung.

A- Utilizzare un cutter per tagliare i nervi che uniscono i pezzi alle lastre, in modo che possano essere rimossi senza danneggiarli. Quindi, carteggiare leggermente i pezzi con carta vetrata a grana media, per rimuovere ogni possibile sbavatura del legno e i resti dei nervi del punto d'unione. Seguendo l'ordine alfanumerico, inserire e incollare i pezzi indicati nelle immagini. Prima di incollare le coste, da A2 ad A11, verificare che si adattino correttamente alla posizione "fermando" i corrispondenti giunti della falsa chiglia, A1. È importante che le coste siano completamente perpendicolari alla falsa chiglia in modo tale che in seguito il ponte si adatti correttamente. Per questa operazione utilizzare colla bianca. Tenere le parti immobilizzate fino a quando l'adesivo non si asciuga.

B- Utilizzare una matita e un righello per trovare il centro del ponte, B1, e tracciare una linea longitudinale su di esso, che lo divida in due metà simmetriche. Raggruppare circa 24 lastre, B2, far corrispondere bene i loro profili, e immobilizzarle con le pinze. Utilizzare una matita per evidenziare i profili delle lastre. Prendete del nastro adesivo (nastro da pittore) e mettetelo su un pezzo di legno o simile, con il lato adesivo rivolto verso l'esterno. Poi posizionare le lastre sul nastro in modo che rimangano ben unite tra loro. Con una spatola applicare uno strato sottile e uniforme di colla a contatto sulle lastre B2. Subito dopo, separare le lastre una per una e riservarle con il lato adesivo rivolto verso l'alto. Si dovrebbe anche applicare uno strato di colla a contatto su metà del ponte B1. Quando la colla non si aggancia più con il contatto delle dita, è il momento di iniziare a rivestire il ponte. Posizionare le lastre B2, una per una, sul ponte spalmando di colla e premere affinché aderiscano bene. Utilizzare il manico di legno di uno strumento per sfregare bene le lastre allo scopo di farle aderire saldamente. Rivestire il resto del ponte fino a quando non è completo. Quindi posizionarlo con le lastre rivolti verso il basso e con un cutter tagliare il materiale in eccesso che sporge dal suo contorno. Non tagliare le lastre negli incavi della costa, vedi figura 18 per vedere come dovrebbe essere la costa. Utilizzare un cutter e poi una lima tonda per riaprire i fori al centro del ponte.

Carteggiare l'intera superficie del ponte con carta vetrata. Per simulare il fasciame del ponte, è necessario tracciare delle linee perpendicolari alle lastre. Iniziare disegnando le linee ogni 60 mm, alternando le lastre. Quindi tracciare delle linee ogni 30 mm su lastre alternate. Utilizzare la matita per segnare due punti su ogni lato delle linee trasversali per simulare l'inchiodatura. Applicare su tutta la superficie del ponte una vernice satinata incolore alla nitrocellulosa. Carteggiare la parte superiore dell'ultima costa per facilitare il supporto del ponte. Applicare la colla bianca, per incollare il ponte. Per aiutare a immobilizzare il ponte si può anche applicare della colla rapida. Assicurarsi che le sporgenze superiori dei telai si inseriscano negli incavi della ponte.

C- Incollare i rinforzi da C1 a C4 su entrambi i lati della falsa chiglia. Capovolgere lo scafo e iniziare a levigare dalla prua e spostarsi in avanti verso poppa. Si consiglia di irruvidire i rinforzi e i bordi dei telai, ma senza deformare il loro profilo originale. La levigatura dello scafo deve essere simmetrica, cioè il lato destro deve essere uguale a quello sinistro. La levigatura deve essere effettuata su tutto lo scafo e deve essere progressiva e liscia. Controllare che la levigatura sia corretta con un'asta. Per fare questo, è necessario far scorrere l'asta sulle coste per vedere come si adatta alla loro forma e come l'asta si appoggia sulle coste. Immergere il pezzo C5 in acqua per circa 15 minuti per ripristinarne la flessibilità. Rimuovere l'acqua in eccesso con carta assorbente. Subito dopo, utilizzare un oggetto cilindrico di circa 10 cm di diametro per piegare leggermente il pezzo. Posizionare il pezzo C5 sull'oggetto e premerlo con le dita molto vicino per non romperlo. Si noti che solo la parte anteriore del pezzo deve essere piegata. Applicare quindi una colla rapida e incollare un pezzo C5 sul lato dello scafo. Procedere allo stesso modo per incollare un pezzo C5 all'altro lato dello scafo. Predisporre e incollare il pezzo C6 sul retro dello scafo.

D-E-F- Immergere una coppia di aste D1 in acqua per ripristinarne la flessibilità. Presentarne uno sul lato dello scafo per controllarne la lunghezza. Applicare la colla sui telai appena sotto i bastioni. Posizionare l'asta e inchiodarla con i chiodini A. per realizzare questa operazione si può utilizzare un'inchiodatrice o un martelletto. Sarà necessario mettere un chiodino A nelle aree in cui l'asta si interseca con una costa. Una volta inchiodata l'asta lungo lo scafo, è necessario tagliarne l'eccesso della parte anteriore e posteriore. Si devono incollare e inchiodare le aste su entrambi i lati dello scafo per ottenere una finitura simmetrica. È importante incollare anche le aste tra loro. Man mano che si procede con il rivestimento dello scafo, si trovano zone in cui l'asta non si piega bene ed è a questo punto che è necessario tagliarla a misura. Incollare le aste il più vicino possibile per ottenere un buon ponte. Far avanzare il fasciame dello scafo dal fondo dei bastioni fino al fondo della falsa chiglia e poi di nuovo indietro. Man mano che il rivestimento dello scafo si chiude, si formeranno spazi cuneiformi. Elaborare questi cunei tagliando delle aste F1 e modellandole con una levigatrice. Poi incollarle insieme per chiudere lo scafo. Rivestire anche il retro dello scafo e levigarlo per adattarlo all'ultima costa.

G-H-I- Usare le levigatrici per levigare il rivestimento dello scafo e così unificarne la superficie. Utilizzare una lima per limare le testine dei chiodini. Controllare il montaggio della parte J1 sulla parte anteriore dello scafo per valutare la levigatura che si deve effettuare. Tagliare strisce di lastre G1 e G2 e rivestire la parte posteriore dello scafo con esse. Tagliare l'eccesso con un cutter. Applicare la colla a contatto sulle lastre G3 e sull'area dello scafo mostrata nelle immagini. Iniziare il rivestimento incollando la prima striscia G3 montata sotto il bastione. Ricordarsi di incollare le lastre su entrambi i lati dello scafo per ottenere una finitura simmetrica. Poi continuare ad incollare le lastre H1 sul fondo dello scafo. Completate il rivestimento dello scafo come avete fatto con il primo rivestimento, chiudendo gli spazi vuoti con cunei su misura. È importante che le lastre siano molto vicine tra loro e che vengano ben sfregate per ottenere una buona finitura. Procedere allo stesso modo per rivestire la parte superiore dello scafo con le lastre I1. Carteggiare l'intera superficie dello scafo per renderlo ben liscio. Fate attenzione, perché le lastre sono molto sottili. Utilizzare carta vetrata media per arrotondare i bordi di due aste I3. Verniciare in color di noce e incollarne una su ogni lato della barca, a 20 mm dal profilo superiore dello scafo.

J- Presentare i pezzi da J1 a J5 sullo scafo per controllarne la misura. Se necessario, ritoccarli. Poi incollarli ben centrati sulla falsa chiglia dello scafo. Smussare e verniciare i pezzi J6 e fissarli con del nastro adesivo sulla parte anteriore dello scafo. Dipingere tutte le superfici dello scafo. Utilizzare del nastro adesivo per proteggere il ponte e dipingere in bianco la parte interna dei bastioni e la poppa. Quindi rimuovere il nastro adesivo. Incollare le parti J7 ben centrate con i fori del ponte. Montare e colorare i pezzi da J8 a J10 in color Noce e incollarli sul ponte contro i bastioni. Preparare e verniciare i pezzi J11 in color Noce e incollarli come mostrato nelle immagini. Smussare con una lima la parte superiore dei pezzi J11.

K- Levigare e verniciare i pezzi da K1 a K5 nel colore Sapelli. Poi incollare i pezzi sullo scafo e verniciarli. Arrotondare i pezzi K6 e K7 con carta vetrata e ritoccare con vernice color noce. Incollare i pezzi K6 e K7, e poi applicare uno strato di vernice turapori. Modellare il pezzo K8 con un'asta e incollarlo all'insieme. Utilizzare pinze da taglio per regolare la lunghezza delle cerniere K9 e dei chiodini K10 in base alle necessità. Incollare e inchiodare le cerniere con i chiodini al pezzo K6. Utilizzare un oggetto piatto per raddrizzare il filo di ottone K11. Per fare questo, arrotolare il filo sotto l'oggetto piatto. Costruire e incollare gli assi K11 alle cerniere del timone.

L- Fare il foro per il timone e ritoccarlo con una lima rotonda o simile. Presentare il timone sullo scafo per verificarne l'adattamento e calcolare la posizione delle cerniere L1. Fissare le cerniere L1 con colla e chiodini L2. Inserire e incollare le parti L3. Usare una matita per disegnare approssimativamente la figura mostrata nelle immagini sul lato dello scafo, e attaccarci sopra il nastro adesivo da carrozziere. Tagliare il nastro adesivo con un cutter e rimuovere la parte mostrata nella foto. In questo modo avrete una maschera per dipingere comodamente. Applicare la vernice nera satinata e, quando si asciuga, rimuovere il nastro adesivo.

M-N- Utilizzare la dima PL-01 per realizzare le decorazioni da M1 a M3. Piegare e tagliare il filo di ottone con le pinze. Poi incollarle sulla barca. Inserire e incollare tra loro i pezzi M4 e M5. Verniciare e decorare i barili M6. Verniciare i supporti M7 in colore Sapelli e incollarli a due dei barili. Realizzare i pezzi M8 e fissare ad essi gli assi M9. Dipingere i pezzi M14 di colore nero satinato e verniciare i pezzi M15 in colore Sapelli. Incollare i pezzi nella barca prendendo le distanze della dima PL-01. Annodare un filo M11 attorno ad un bozzello M10. Inserire un golfare M12 e chiudere il nodo. Applicare un po' di colla e tagliare l'eccesso di filo. Usare le pinze per aprire e chiudere gli anelli M13 e inserirli negli anelli dei golfari M12. Praticare dei fori nel ponte per inserire e incollare i golfari M12. Verniciare le lastre N1 in color pino e tagliarle a misura. Rivestire i pezzi N2. Costruire il boccaporto con i pezzi da N2 a N4. Dipingere il boccaporto e aggiungere i pezzi N5 e N6. Decorare la pompa di sentina N7 e aggiungere i pezzi N5 e N8. Incollare il boccaporto e la pompa di sentina al ponte.

O- Per realizzare il tambucio si devono utilizzare i pezzi da O1 a O4 e rivestirlo con le lastre O5. Verniciare un'asta in color Sapelli e costruire con essa i pezzi da O7 a O11. Da un'altra asta elaborare e incollare i pezzi O12. Poi verniciare l'intero tambucio. Rivestire i pezzi O13 e O14 con il rivestimento O15. Tagliare a misura due pezzi O16 per le porte. Dipingere le tre porte così ottenute. Elaborare e incollare il pezzo O17 e O18 e incollarli. Incollare gli sportelli del tambucio e il comignolo O19 precedentemente verniciato di nero. Incollare il tambucio sul ponte.

P- Per realizzare le lande delle sartie P1, tagliare otto porzioni di filo da 50 mm. Adattare un pezzo P1 attorno ad una bigotta P2 e incrociare le estremità del filo. Utilizzare pinze per intrecciare il filo un paio di giri. Poi tagliare un'estremità della corda e raddrizzare l'altra. Fare un anello alla fine del pezzo P1. Incollare il pezzo P1 sullo scafo come mostrato e inchiodarlo con un chiodino P3. Seguire gli stessi passi per realizzare e posizionare otto lande delle sartie. Inserire e fissare i golfari e i bozzelli mostrati nelle immagini.

Q- Inserire e incollare le parti Q1 e Q2. Poi, dipingere il tutto in nero lucido e mettere in risalto i rilievi dorati. Inserire e fissare un filo Q4 con un anello Q3. Rinforzare l'unione con un filo Q5. Inserire il filo Q4 attraverso il foro dello scafo e annodarlo come mostrato in figura. Poi tagliare l'eccesso.

ALBERATURA

Per realizzare l'alberatura, il primo passo da seguire sarà quello di tagliare le aste secondo le misure indicate nell'elenco dei pezzi, oppure prenderle direttamente dalle planimetrie che sono stampate in scala 1/1.

Tutti gli alberi e i pennoni hanno una certa conicità che si dovrà ottenere.

Per ottenere la conicità degli alberi, occorre scartavetrare le aste (con una smerigliatrice), aumentando l'azione della stessa a misura che ci si avvicina all'estremità dove si deve diminuire il diametro. Far girare l'asta affinché la smerigliatura sia uguale su tutto il contorno, fino ad arrivare al diametro indicato nella planimetria.

Per ottenere la conicità dei pennoni, realizzare le stesse operazioni, ma in questo caso su entrambe le estremità dell'asta. Si dovranno verniciare o tingere le aste in funzione del modello che si stia realizzando.

Per realizzare gli alberi di questo modello in maniera corretta si dovranno utilizzare:

Le planimetrie;

Le foto dettagliate degli alberi;

Le misure e la descrizione dei materiali nell'elenco dei pezzi;

Le pagine "IP" con l'identificazione dei pezzi.

La sagoma PL-01

Gli alberi devono essere smaltati ed alcuni dei pezzi che li compongono devono essere verniciati. Vedi le foto generali dettagliate degli alberi.

Una volta montati e smaltati, devono essere collocati gli attrezzi (stroppi, quarnali, golfare, bozzelli, ecc.) e fissati al vascello. Gli alberi devono essere introdotti fino in fondo negli appositi incastrati della falsa chiglia.

SARTIA

Per elaborare la sartia di questo vascello occorre seguire l'ordine alfabetico delle figure stampate delle planimetrie, che indicano l'ordine di collocazione delle cime, delle bigotte, dei bozzelli, delle vele, ecc., risaltati in colore rosso. L'elenco dei pezzi serve ad orientare in merito al tipo di materiali ed alle misure da utilizzare.

Per simulare l'invecchiamento delle vele, queste possono essere bagnate con te, senza farle bollire, e poi lasciarle asciugare mantenendole ben arrugate. Poi si collocano senza stirarle, affinché mantengano corpo.

SERVIZIO ASSISTENZA CLIENTI

Per qualsiasi dubbio o informazione sul montaggio dei nostri prodotti, contattare il nostro **Servizio Tecnico** al seguente indirizzo **www.occre.com**.
Saremo lieti di poterVi aiutare.

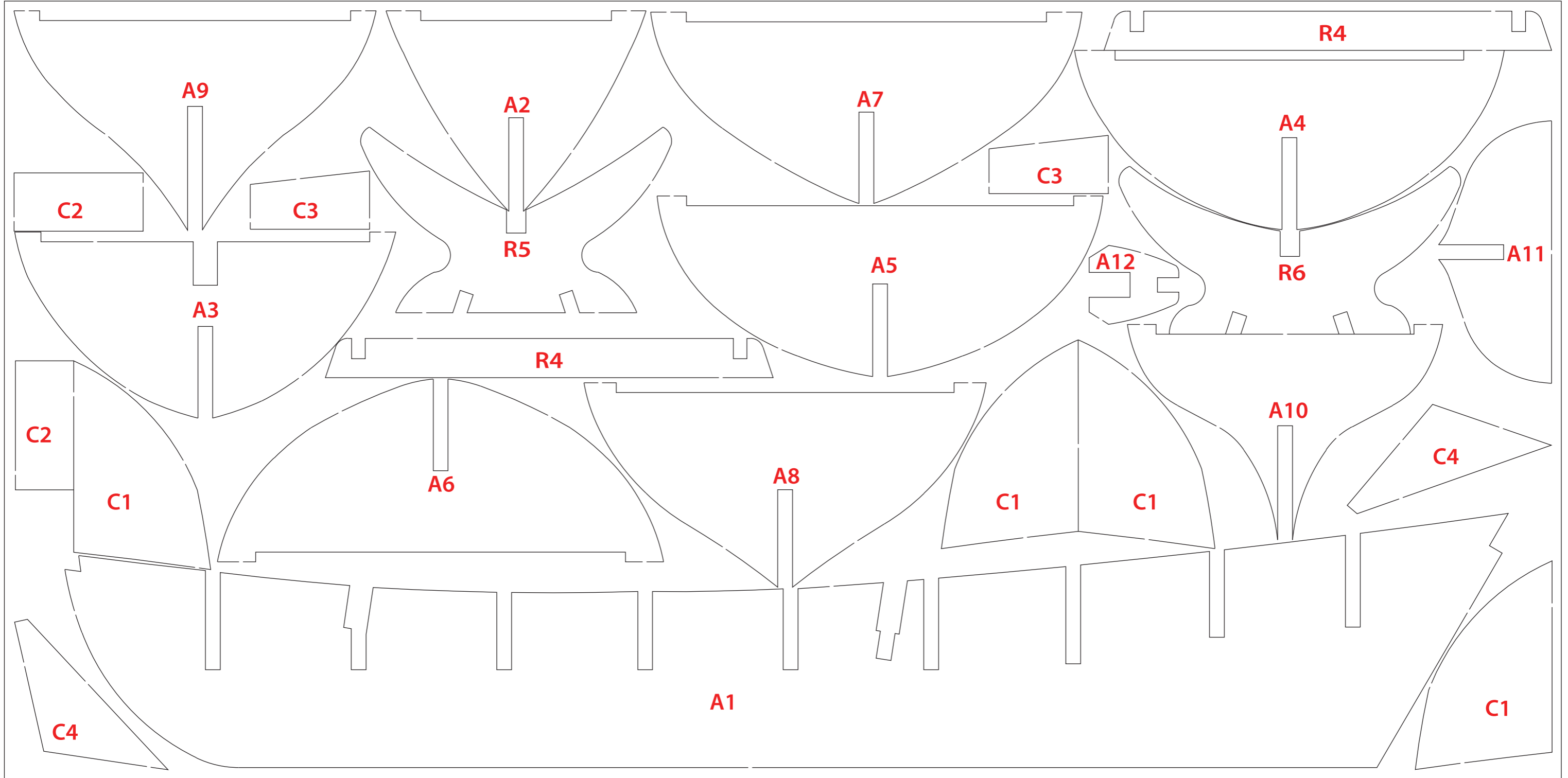

12007-1



Ref.12007

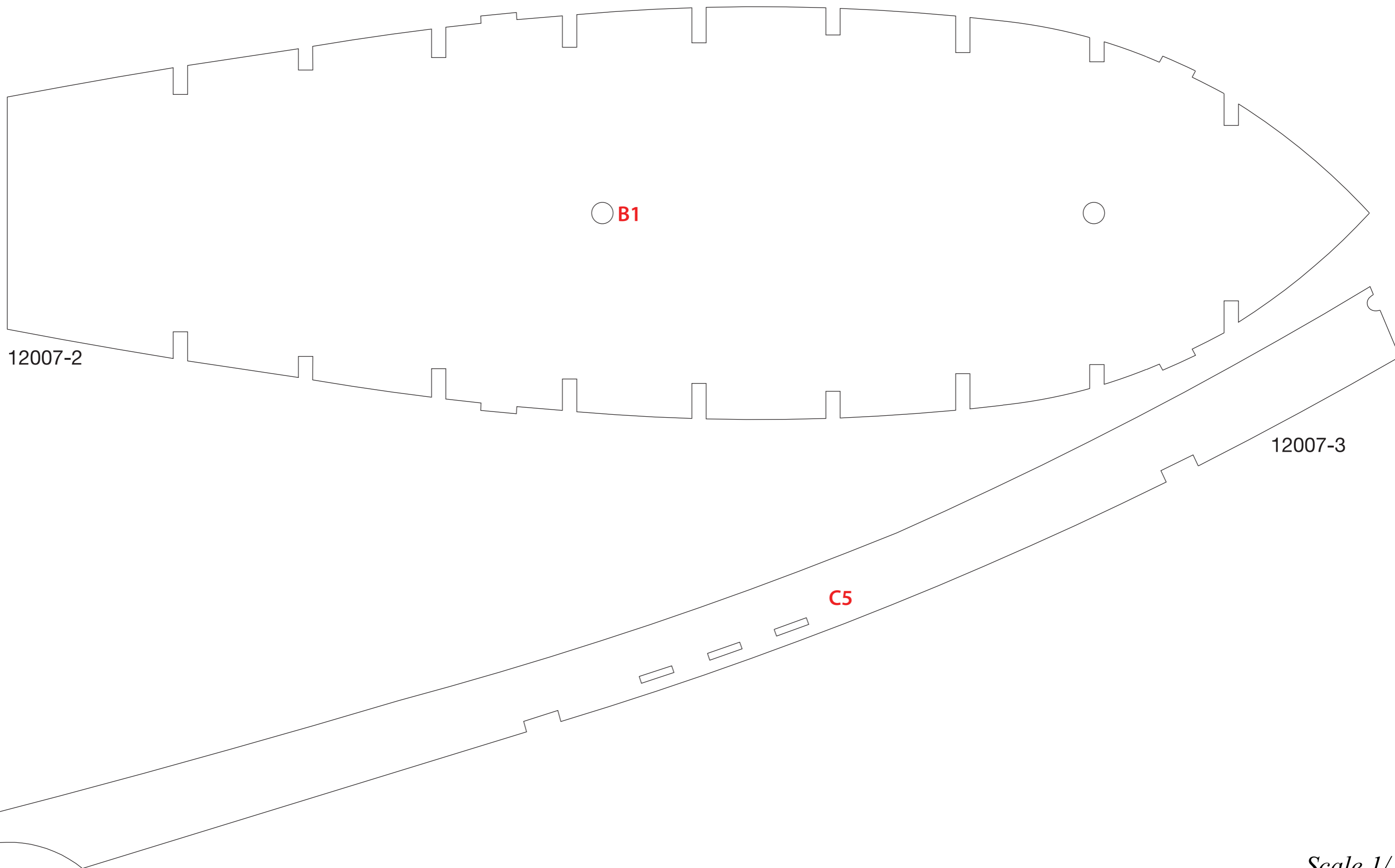

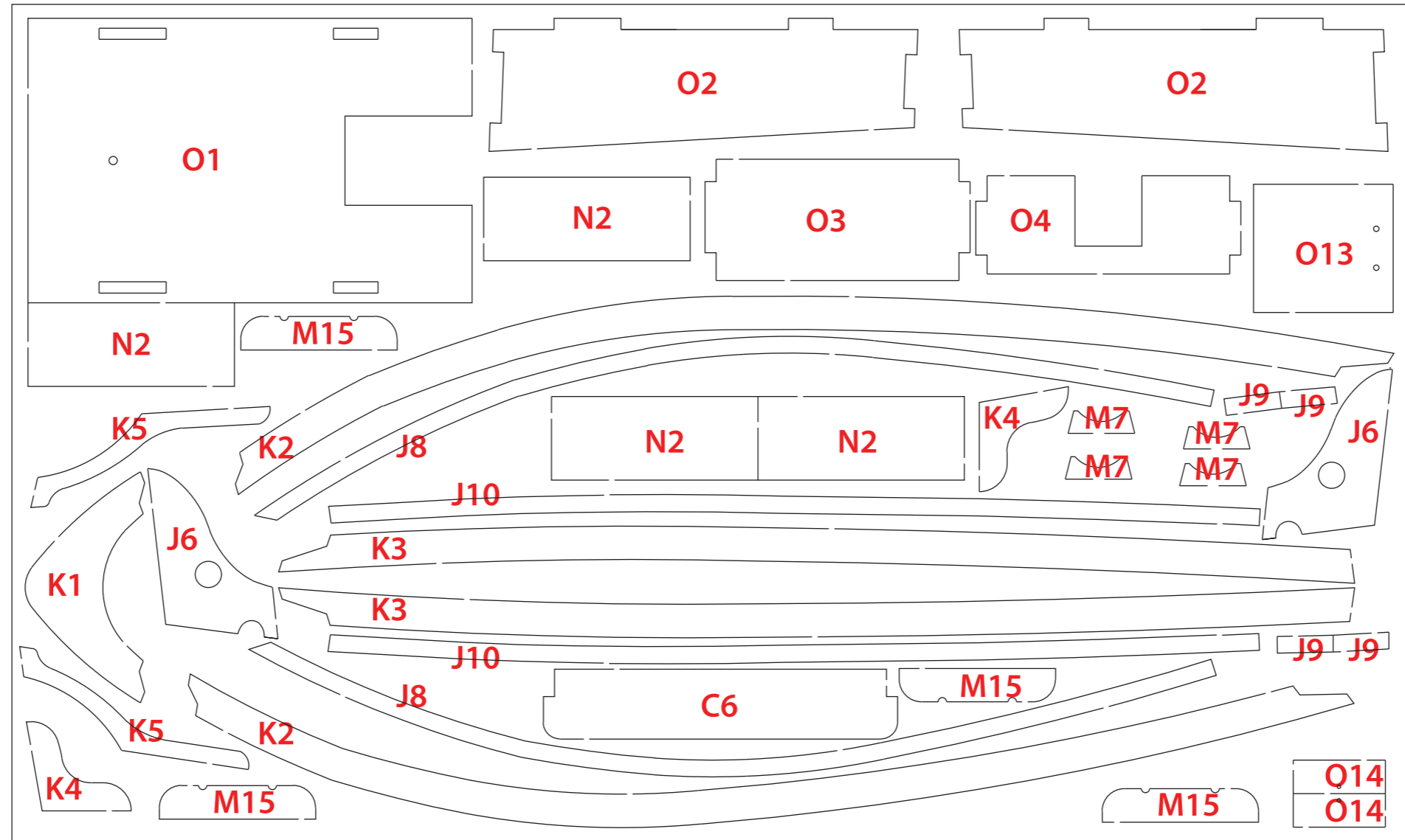

12007-4

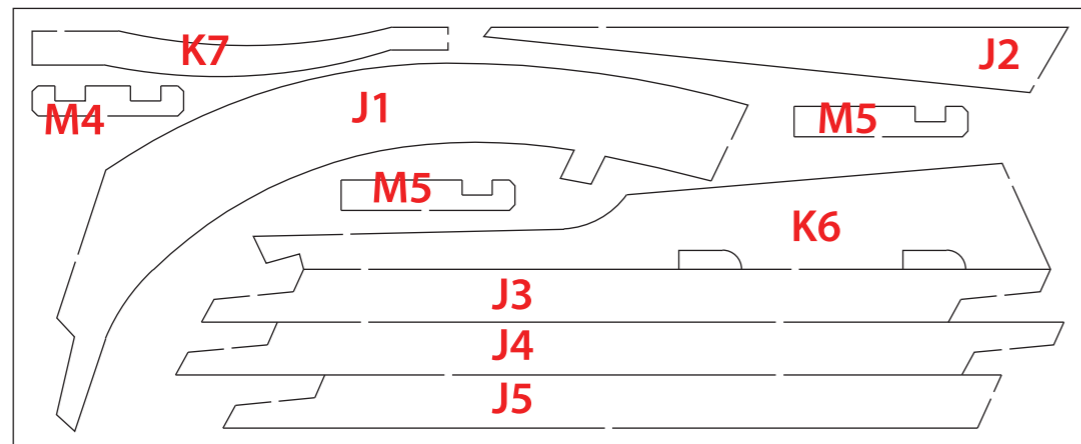

12007-5



12007-6

Polaris PL-01

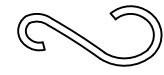
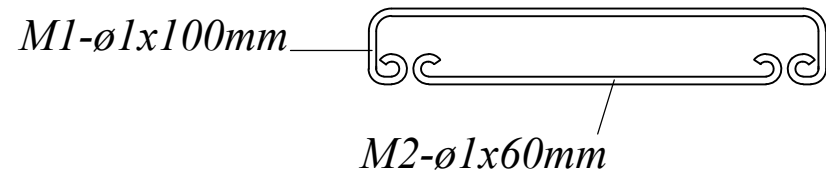

M3-ø1x40mm



ø17-ø1x16mm

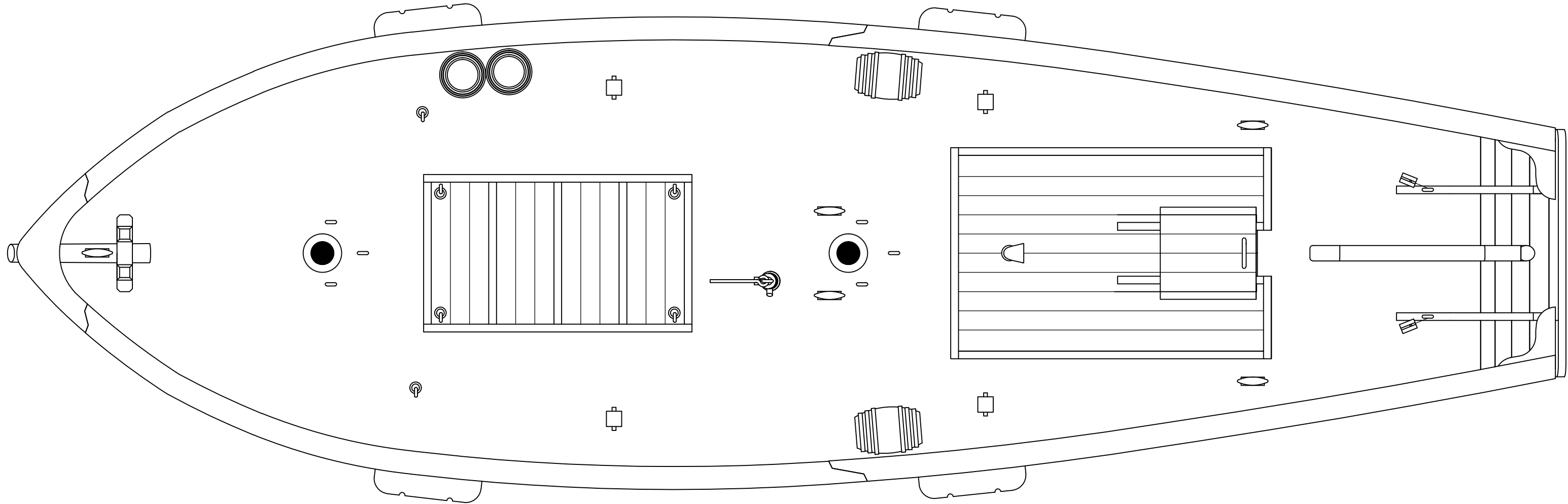

ø0,5x100mm x5

ø1x100mm x5

ø1,5x100mm x1



Accede a vídeos tutoriales fotografiando los códigos QR.
Access tutorial videos photographing QR codes.
Accédez aux didacticiels vidéo photographiant les codes QR.
Greifen Sie auf Video-Tutorials zu, die QR-Code fotografieren.
Accedi ai video tutorial fotografando i codici QR.
Доступ к видеоурокам фотографирования QR-кодов.

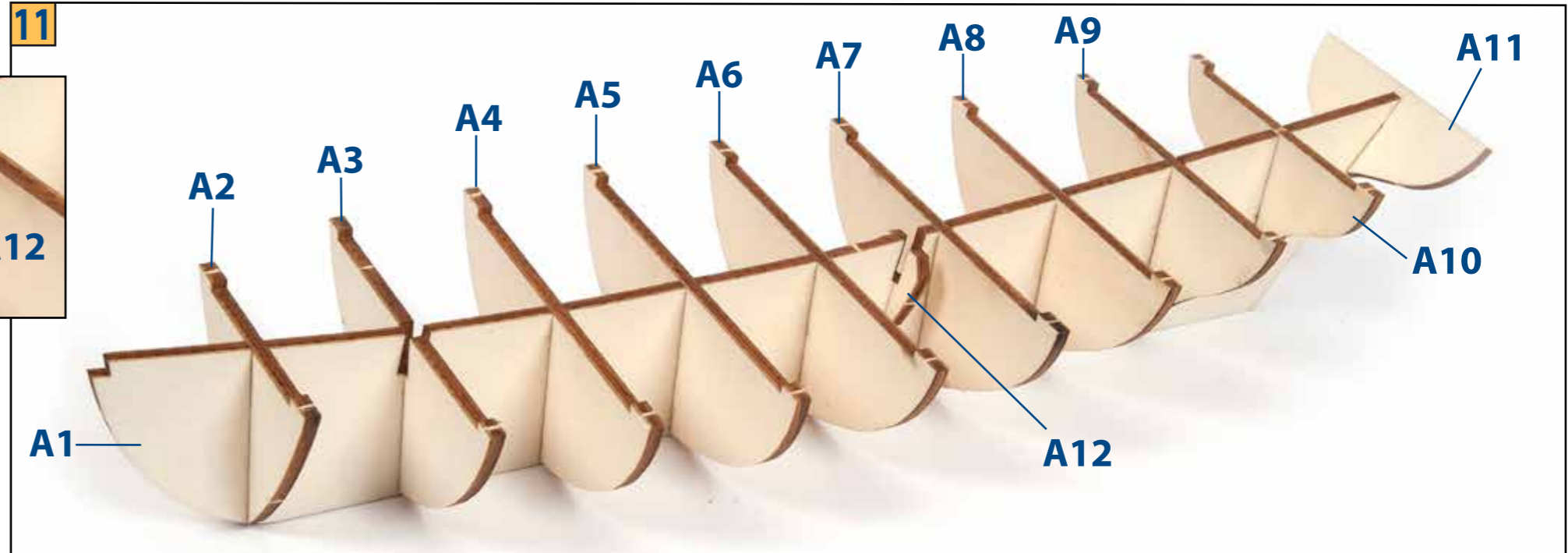
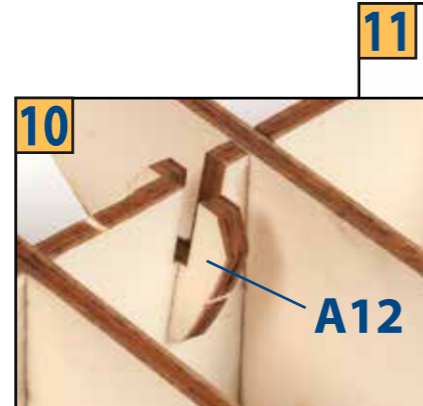
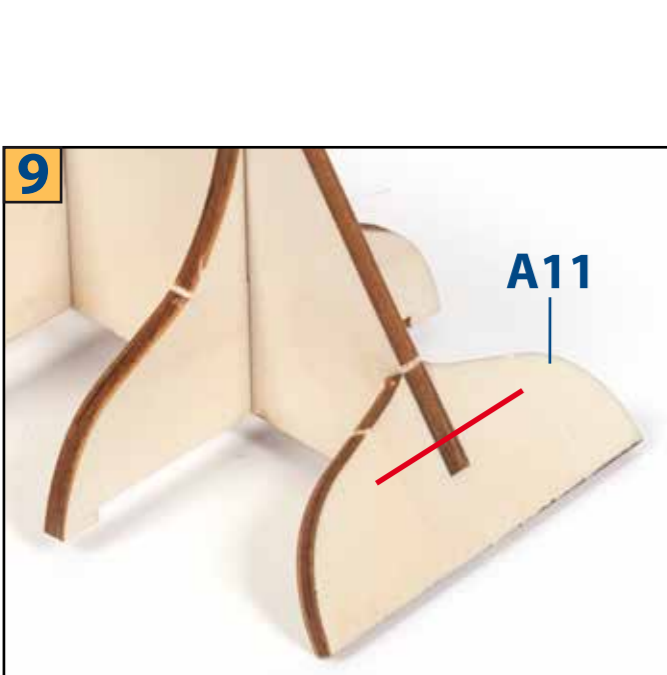
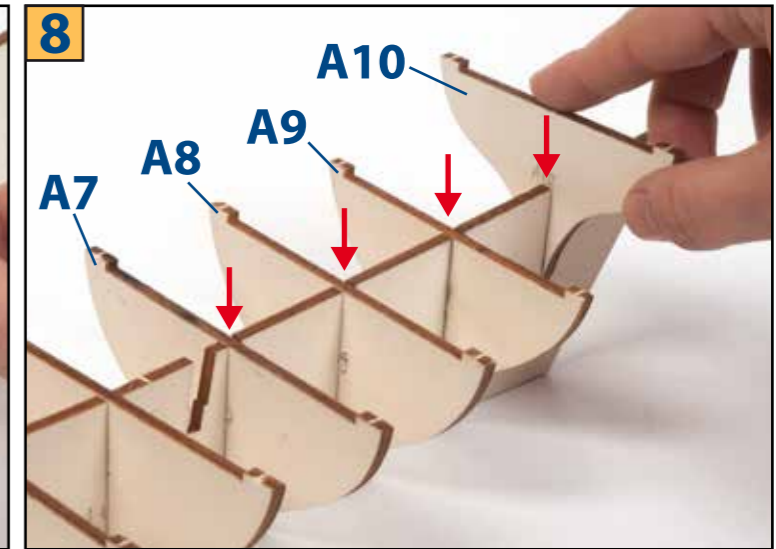
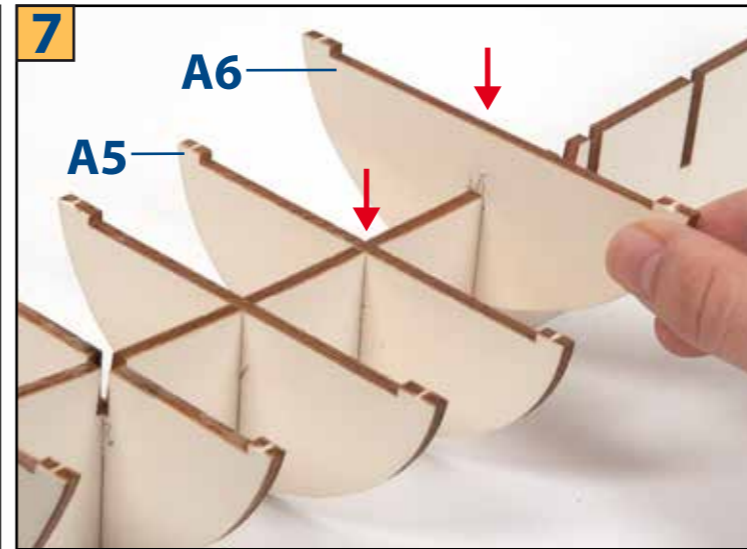
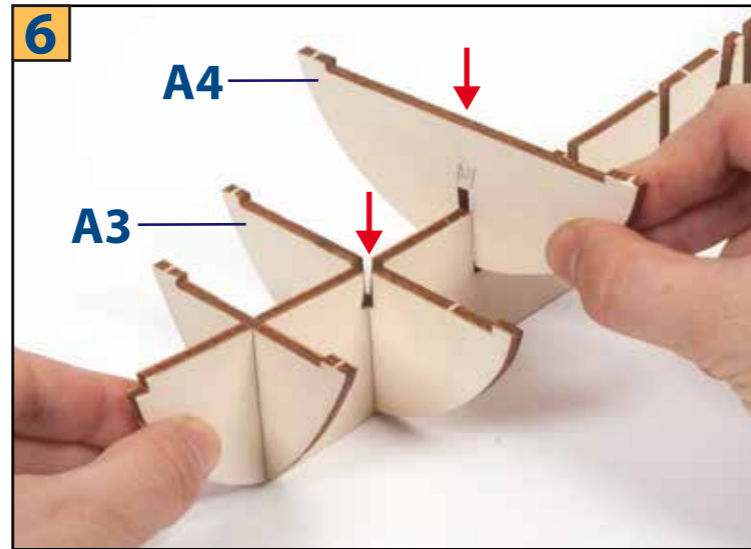
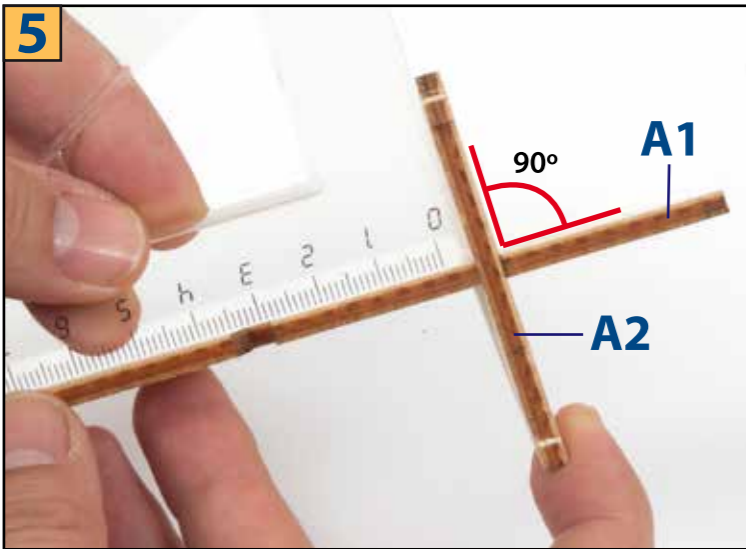
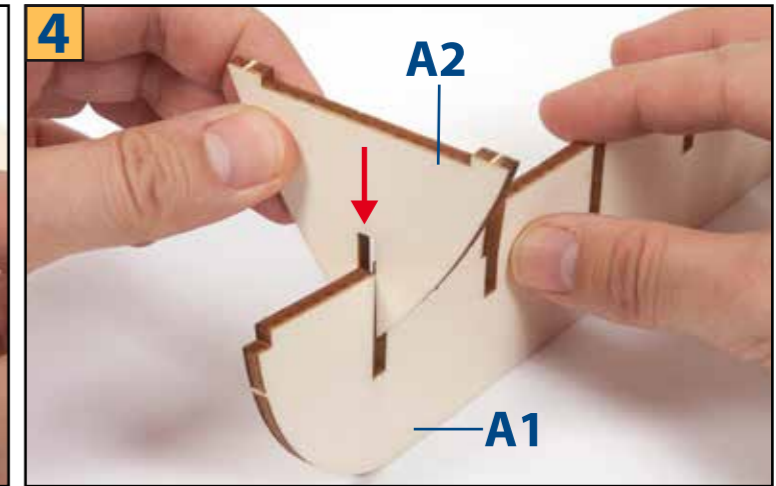
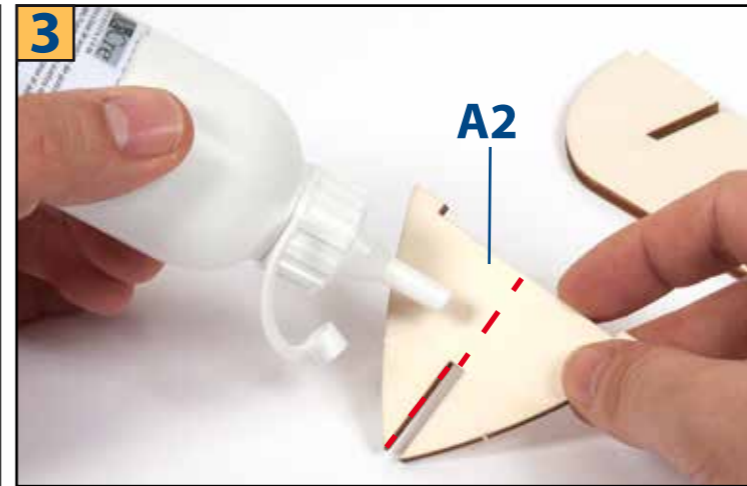
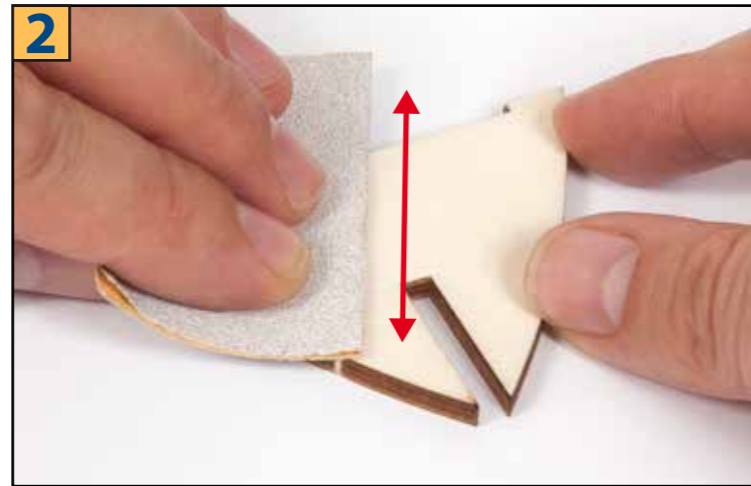
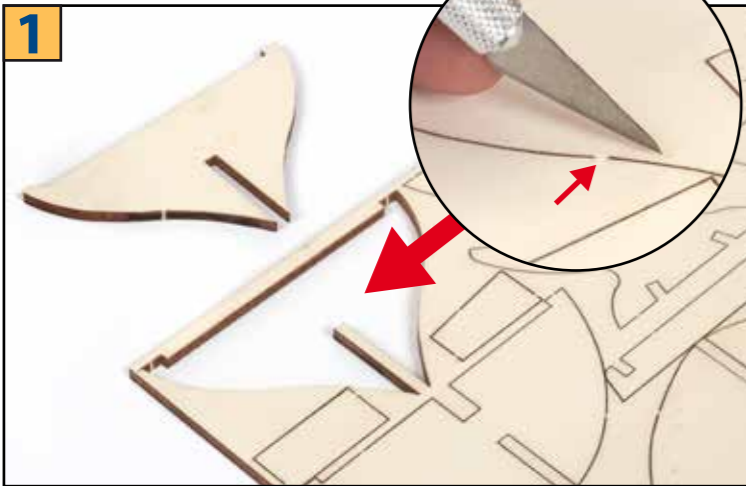

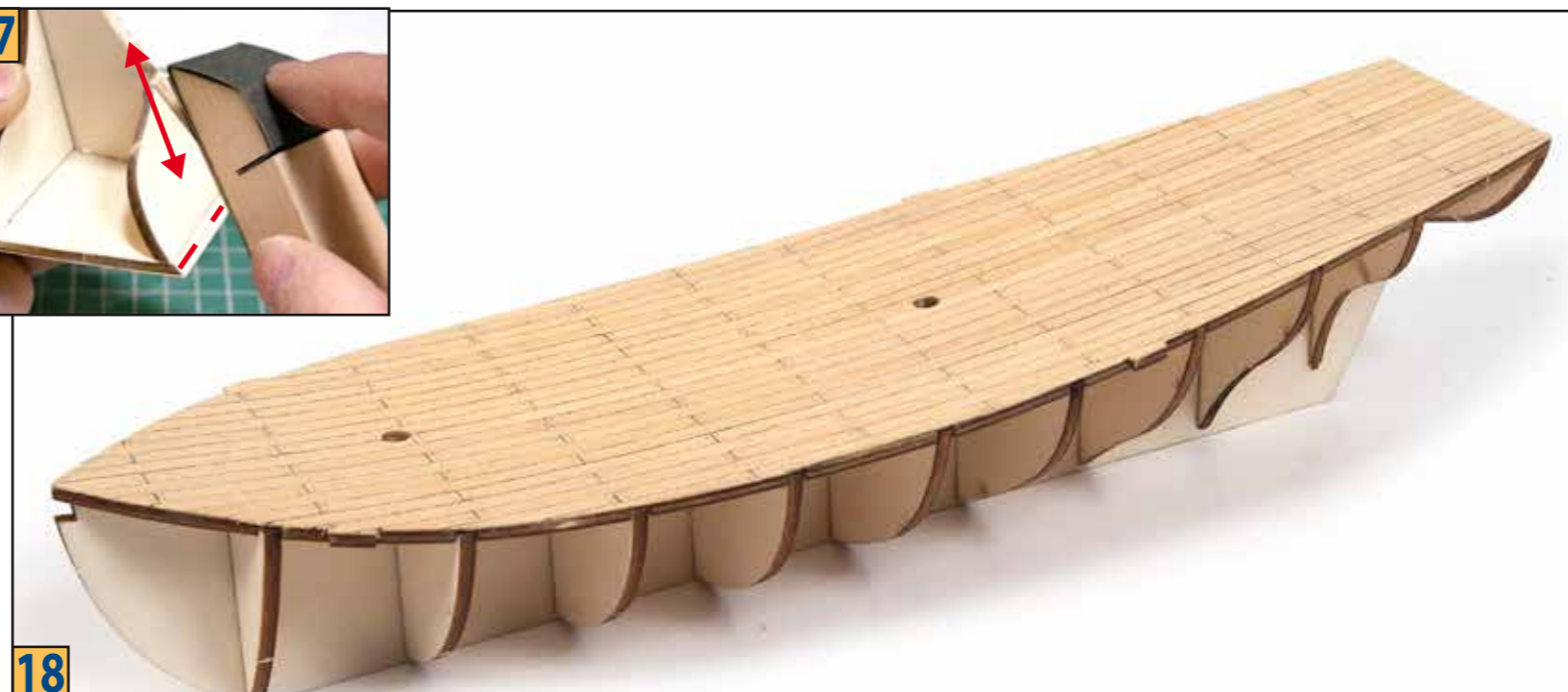
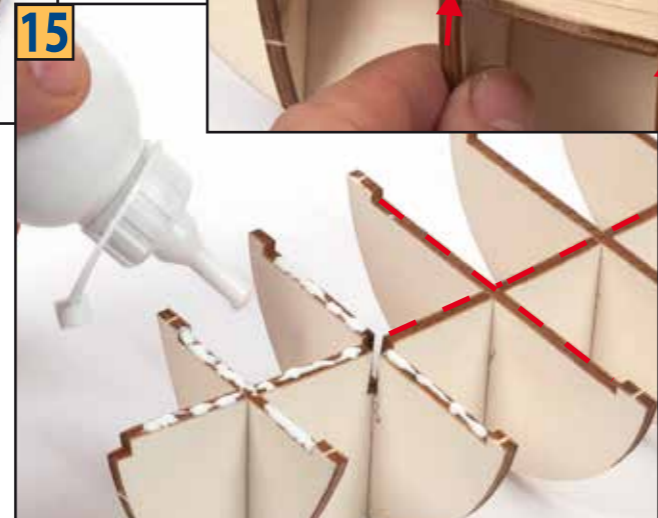
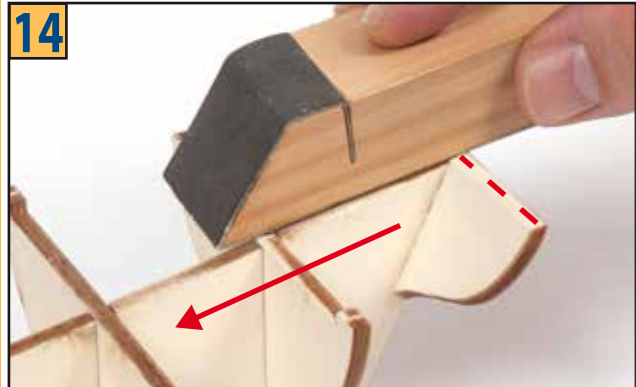
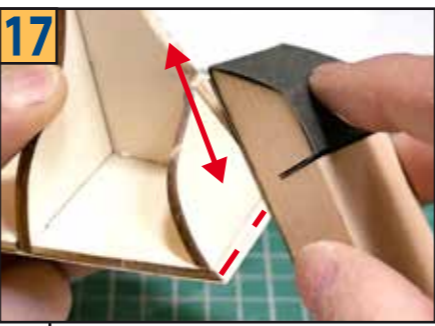
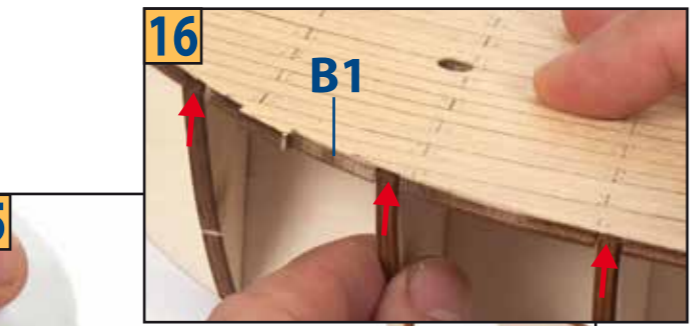
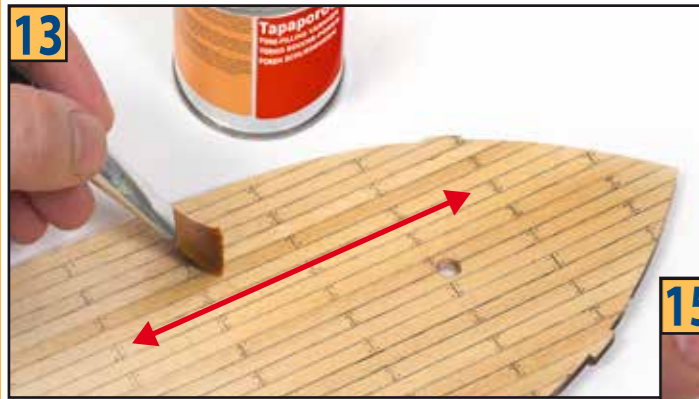
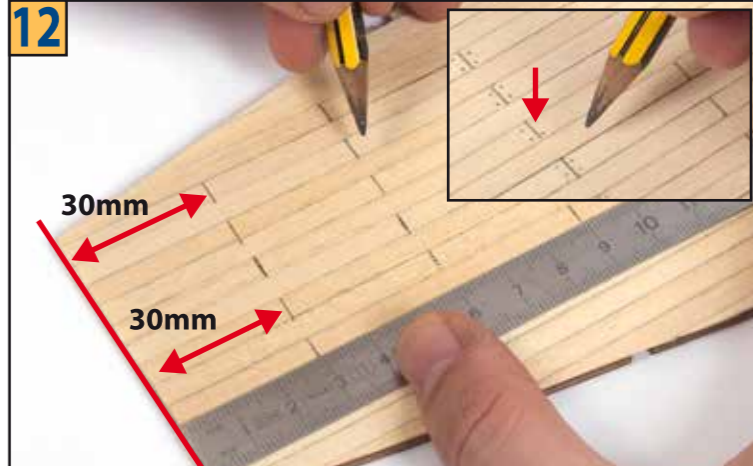
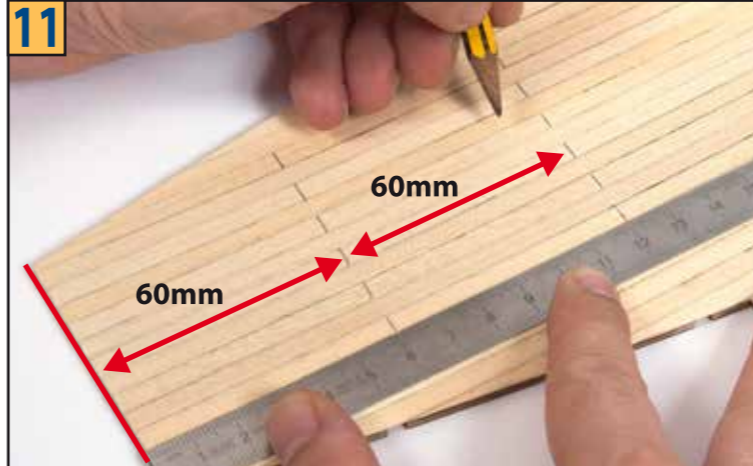
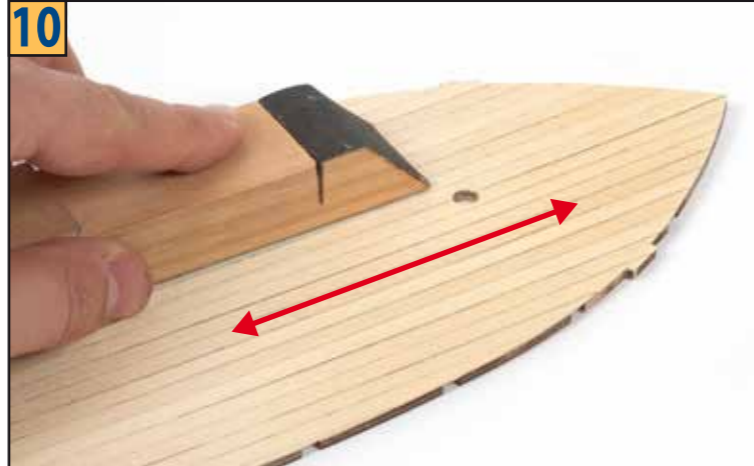
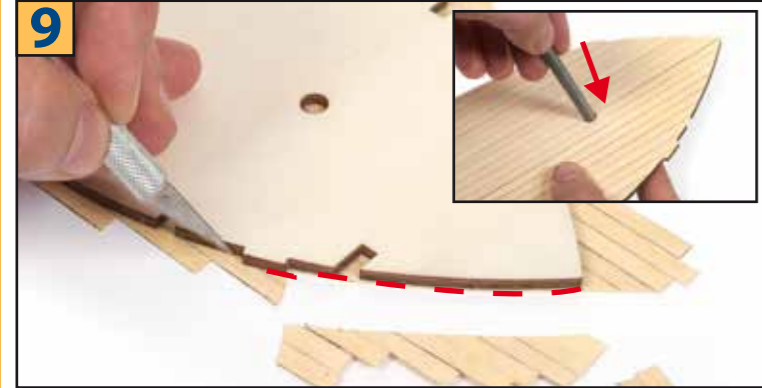
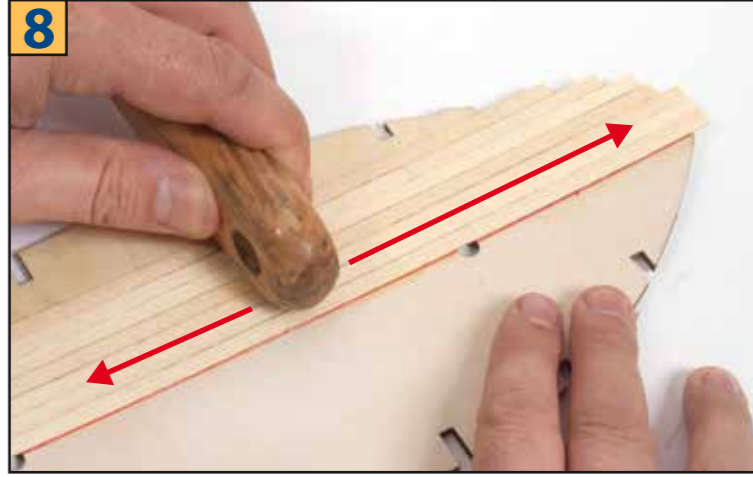
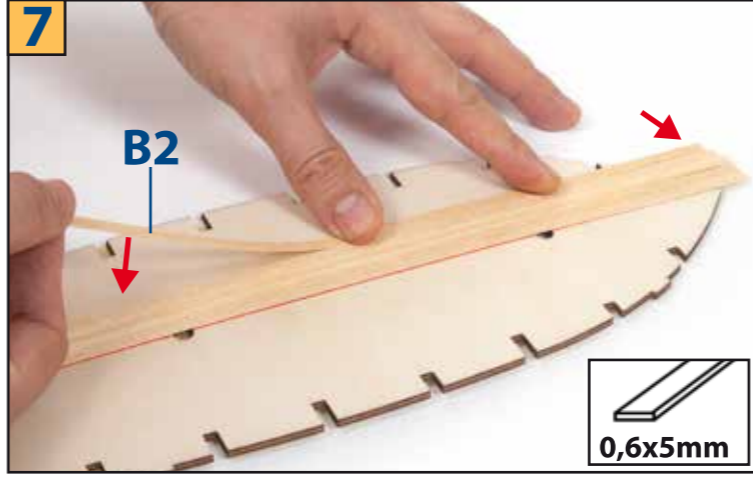
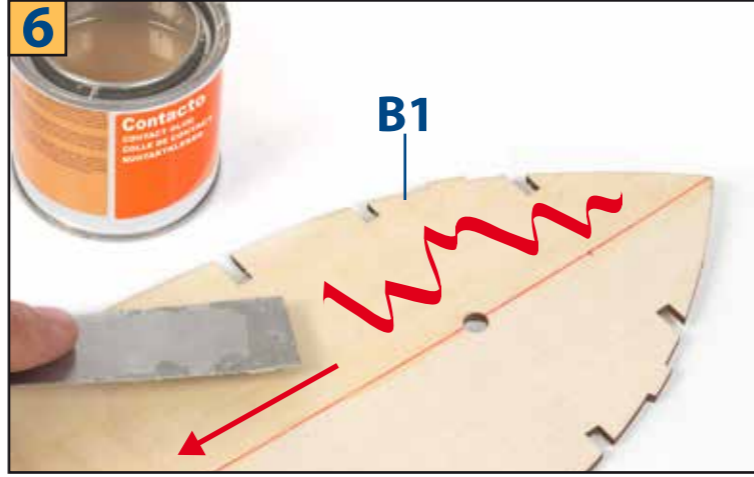
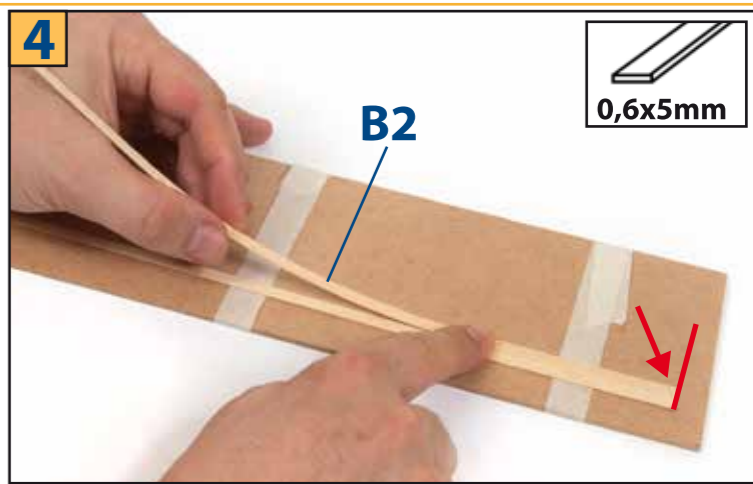
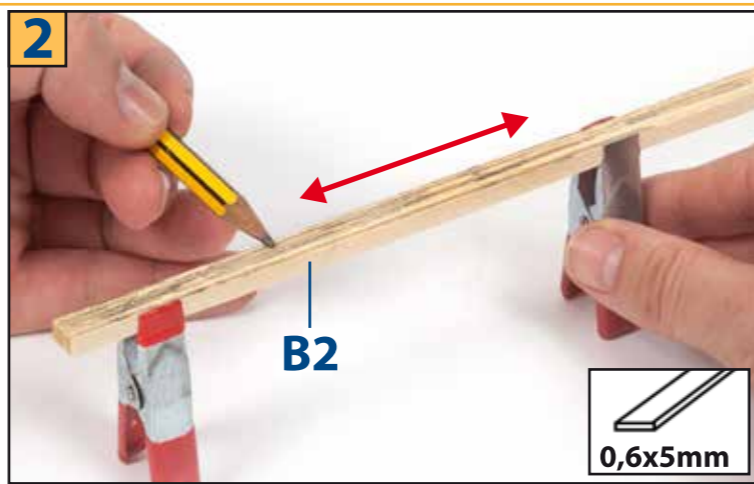
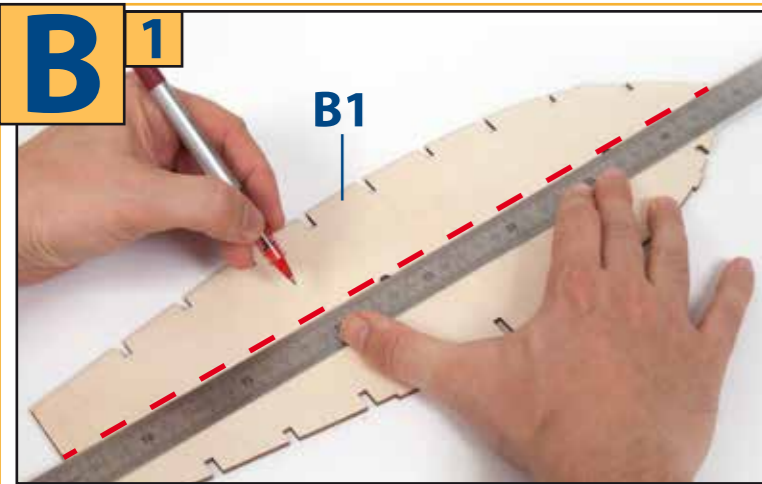

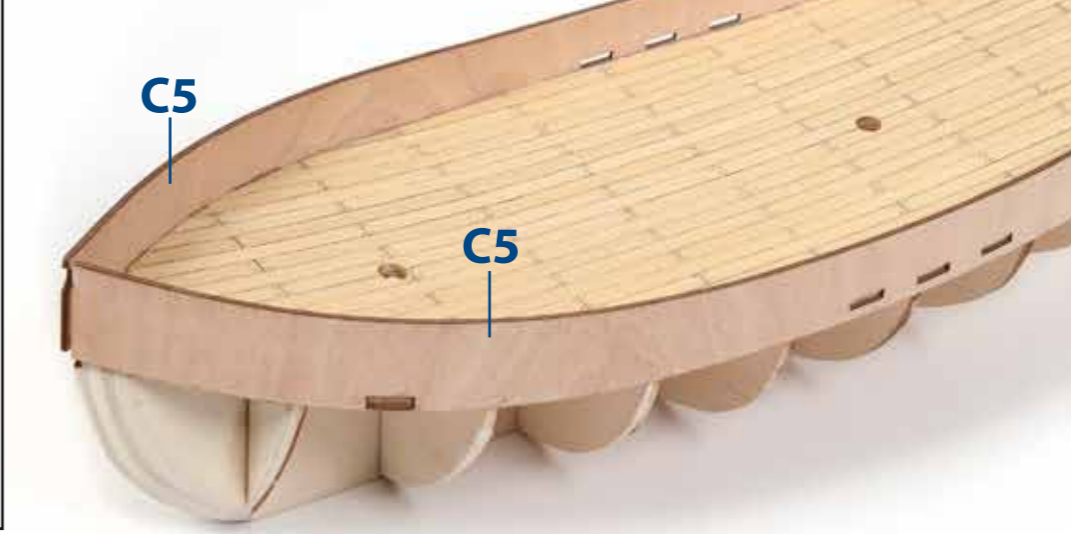
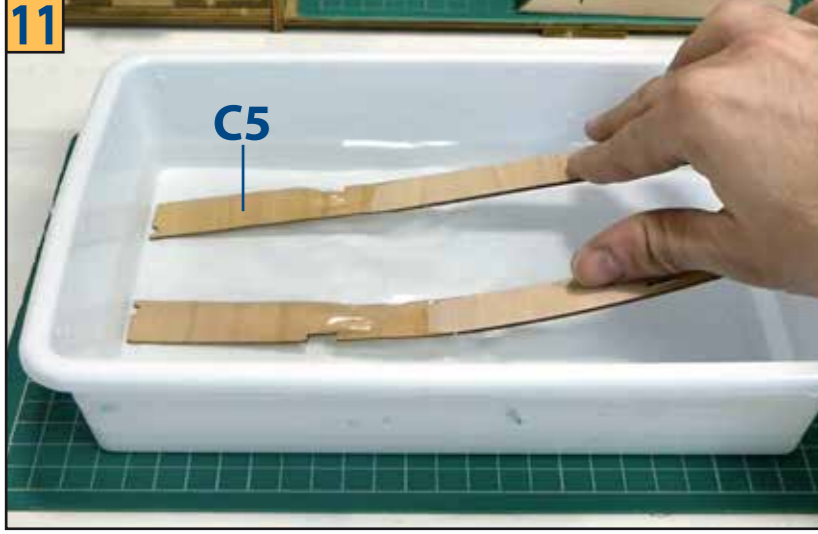
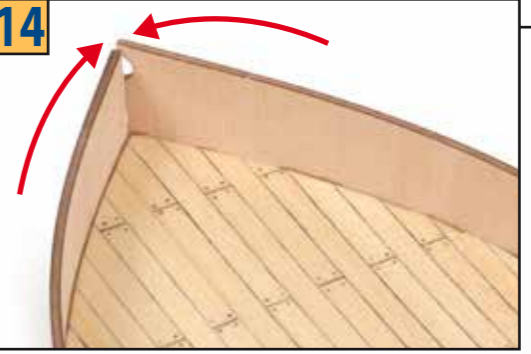
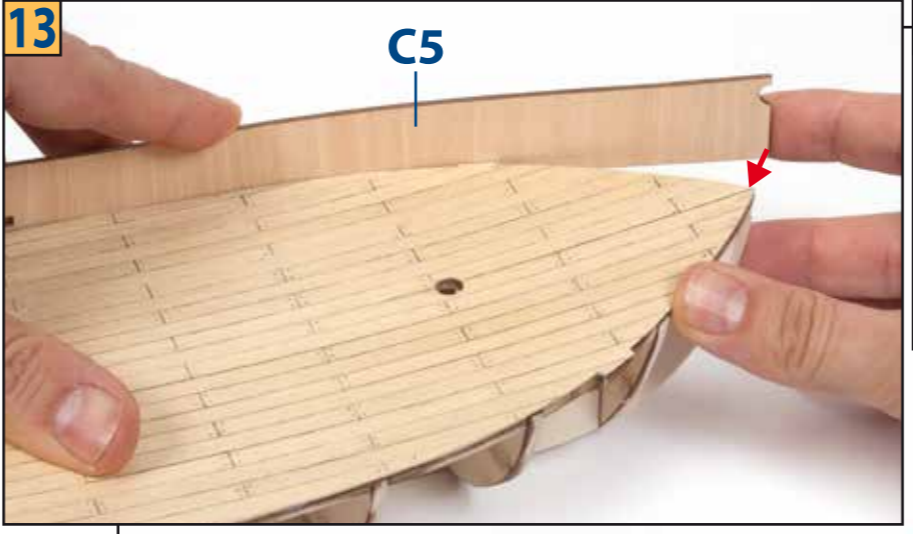
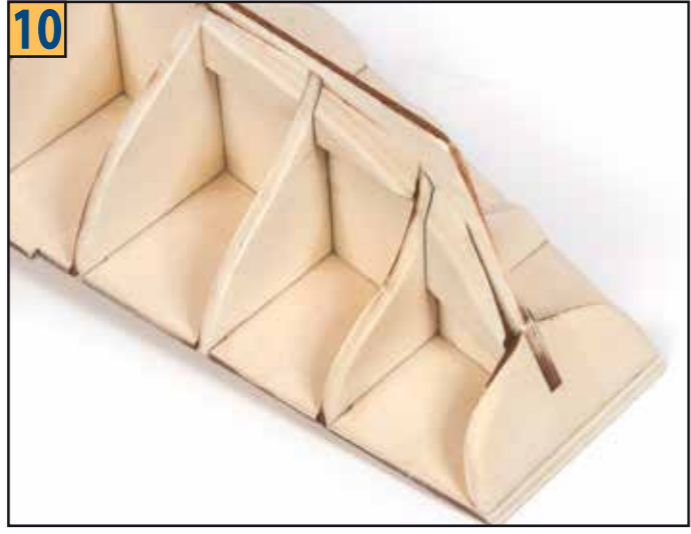
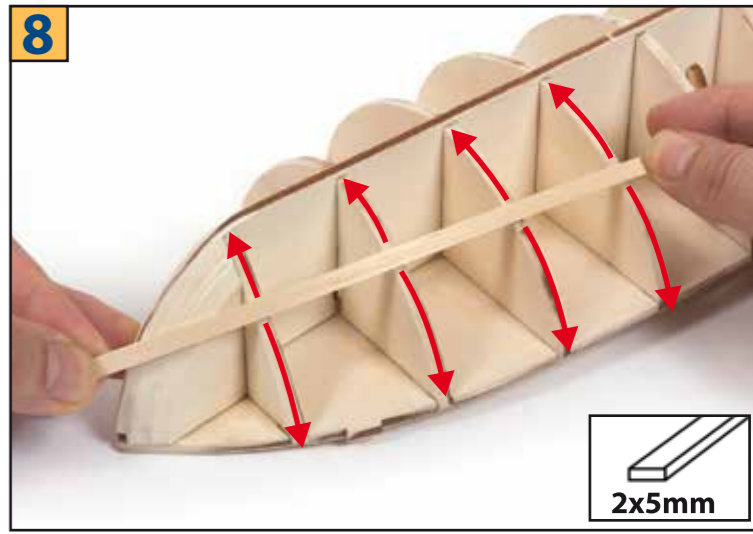
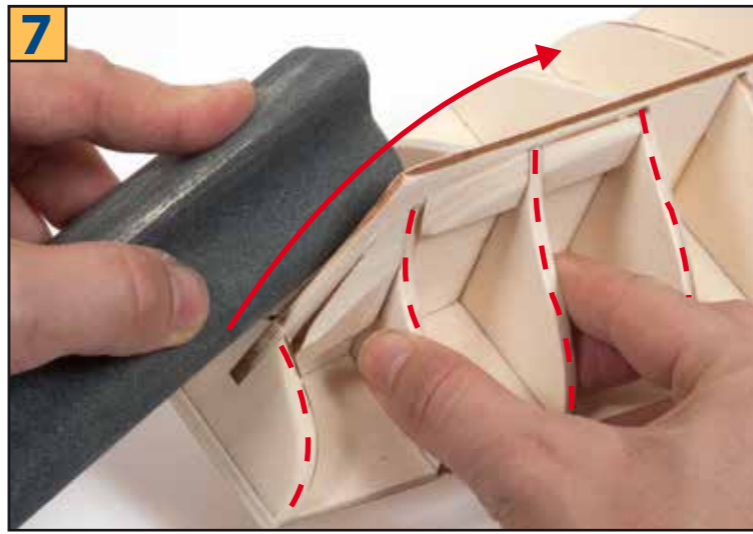
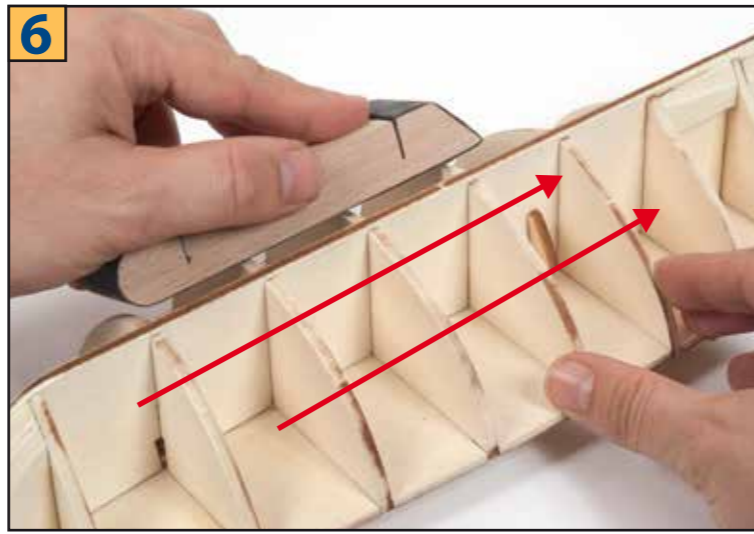
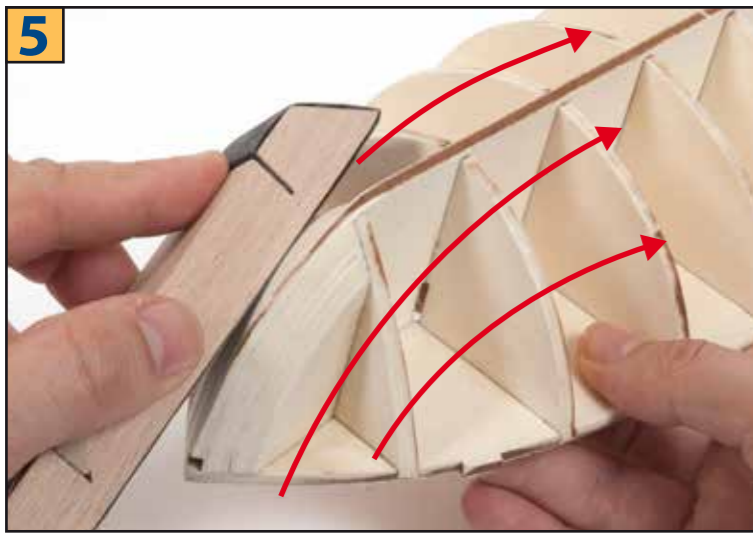
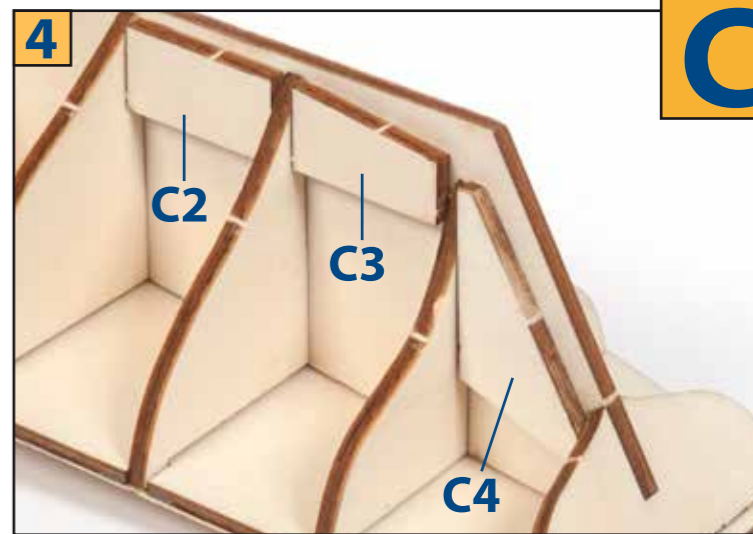
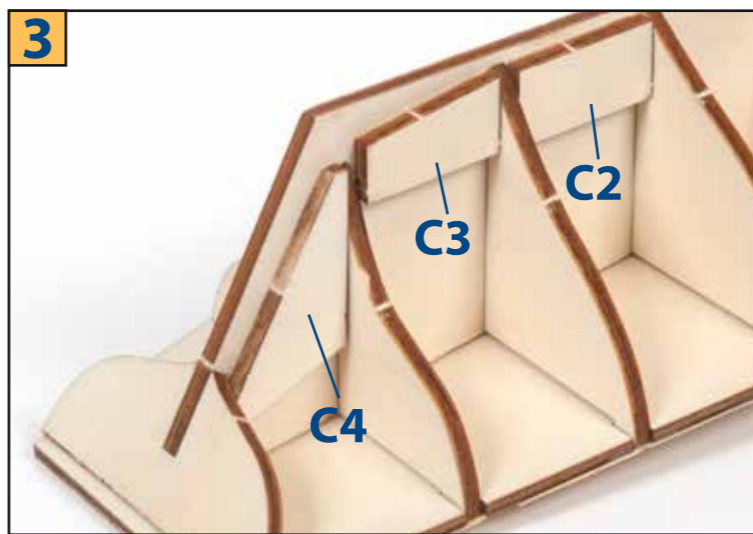
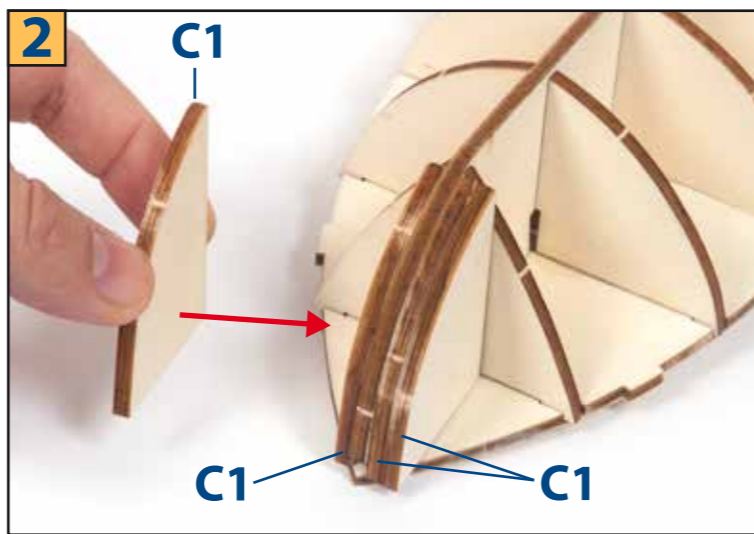

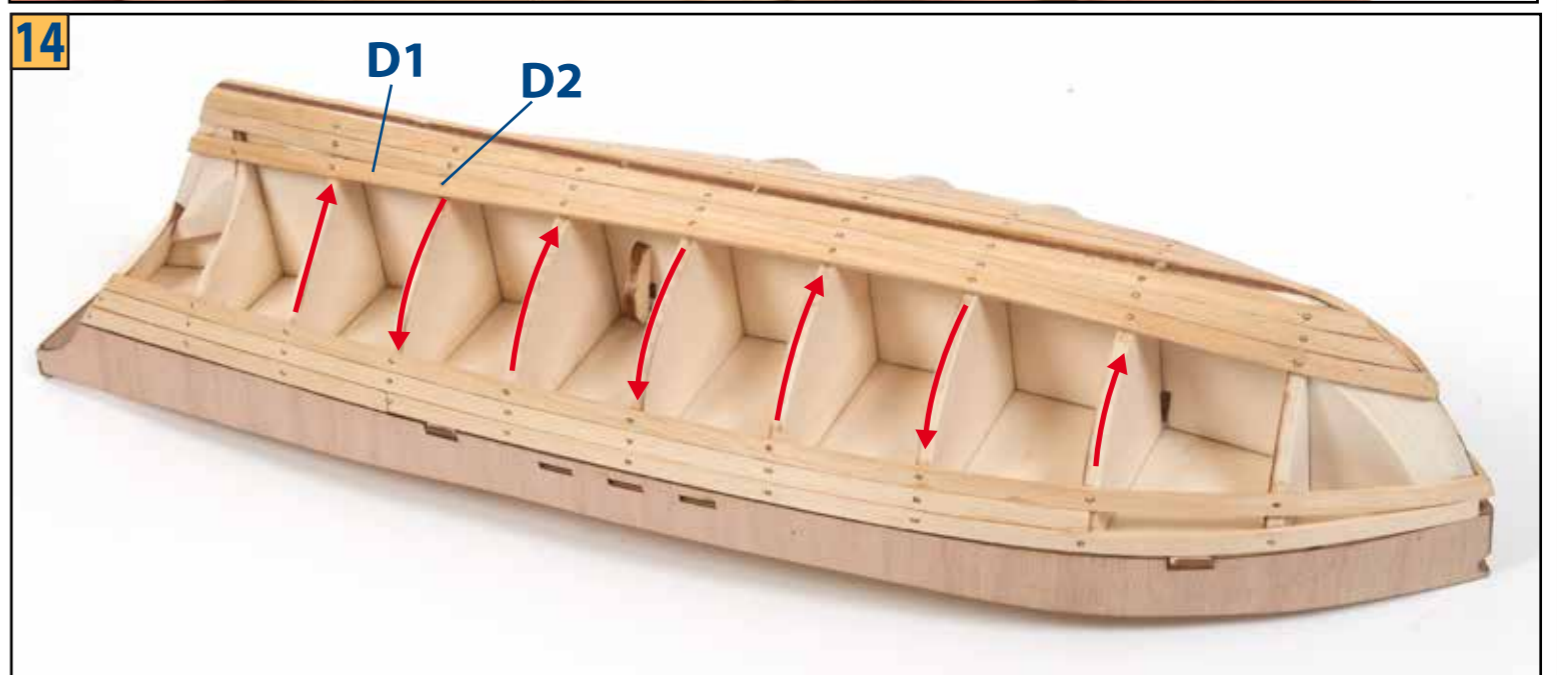
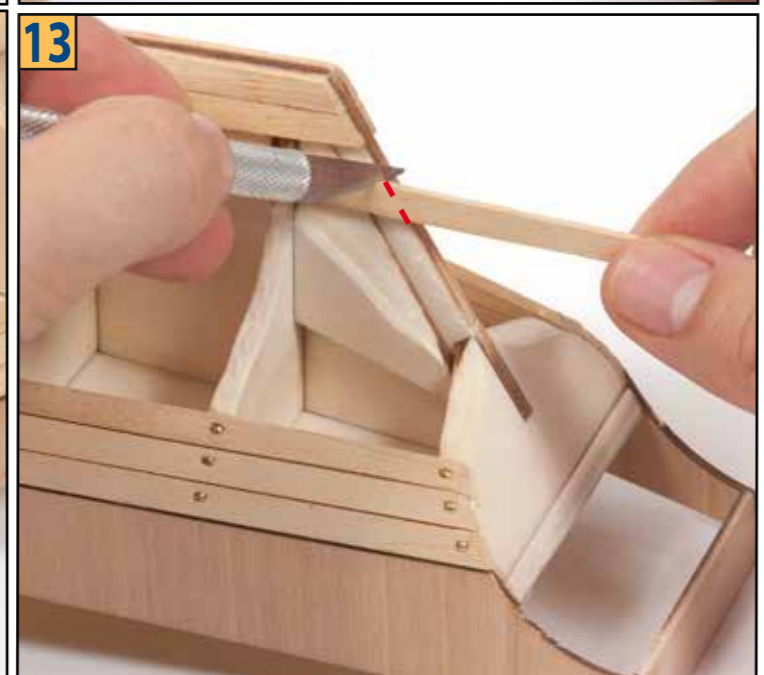
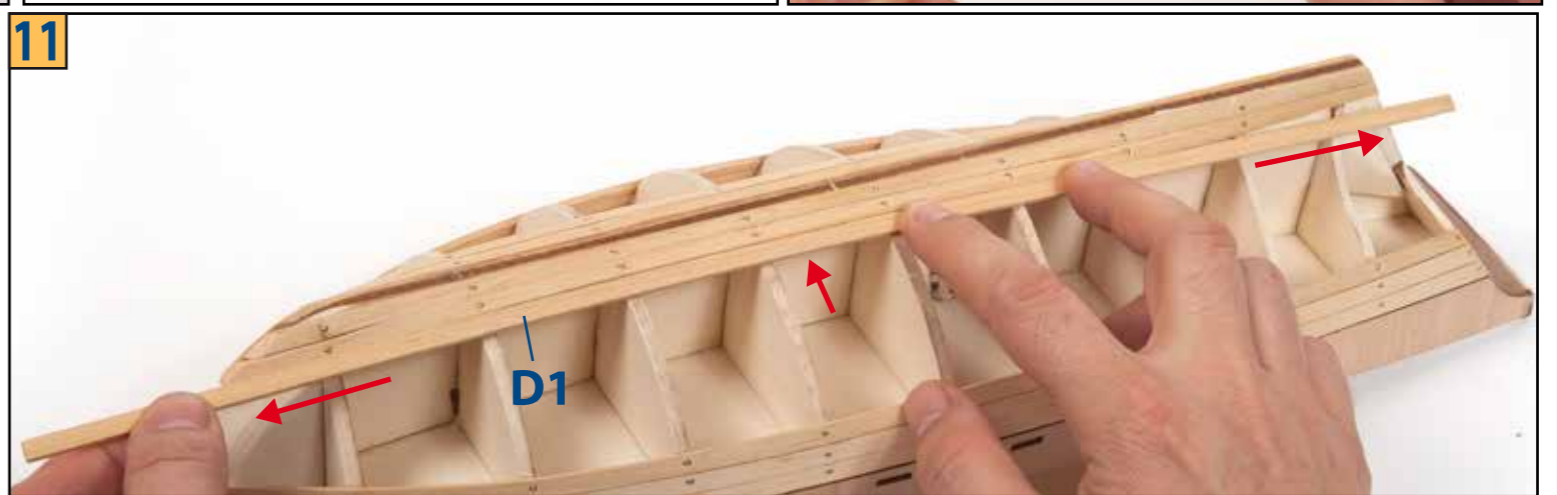
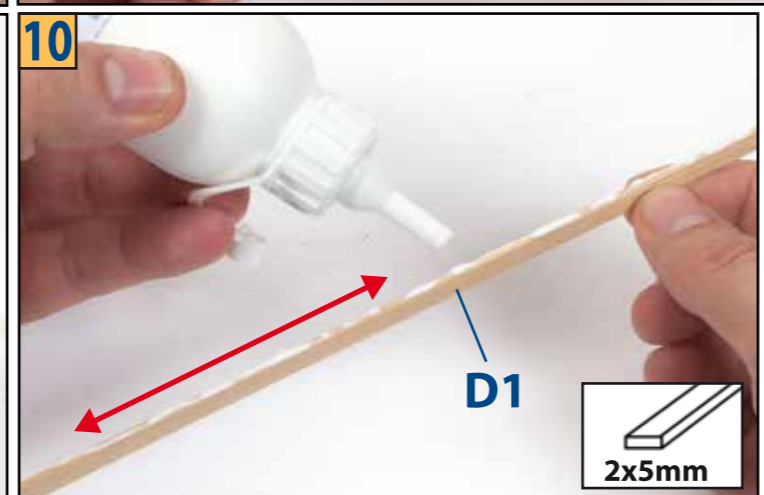
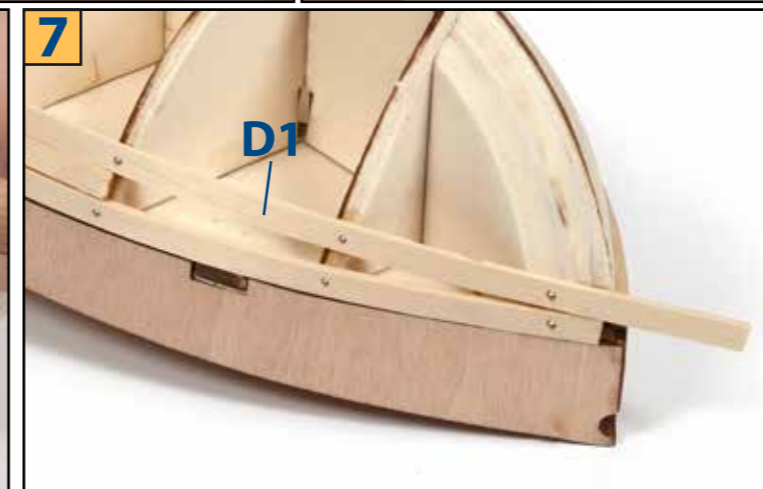
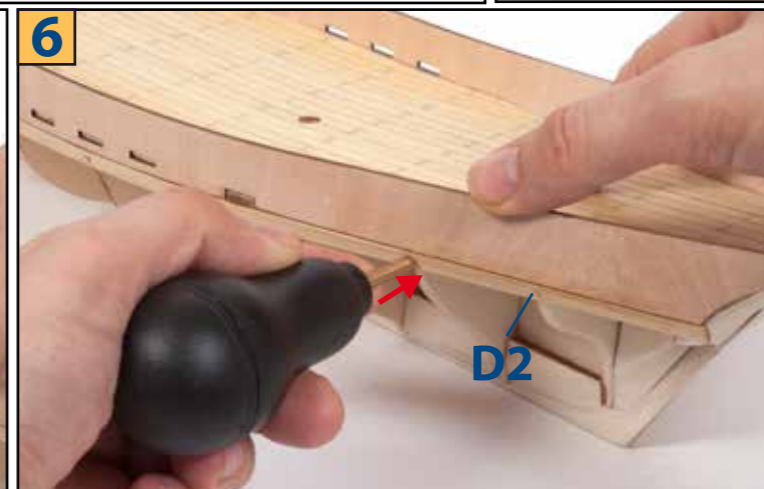
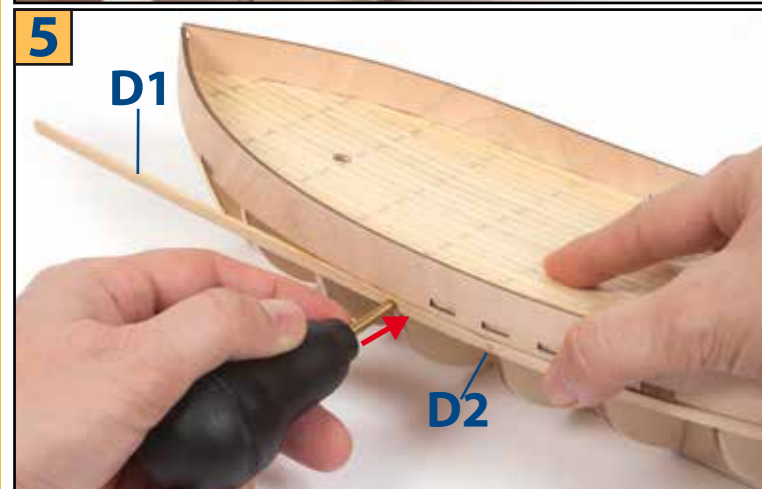
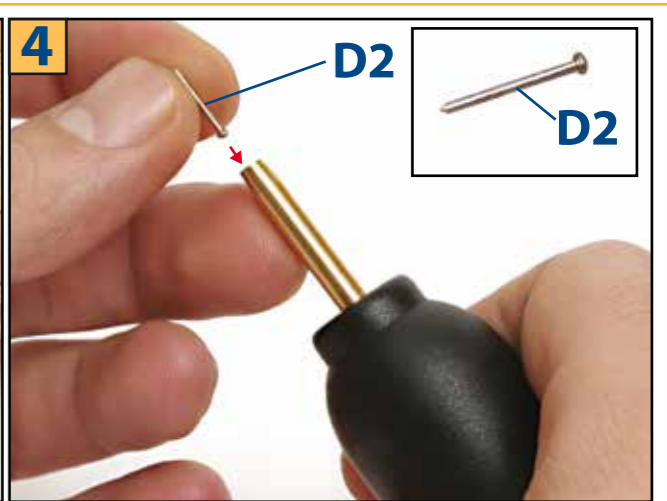
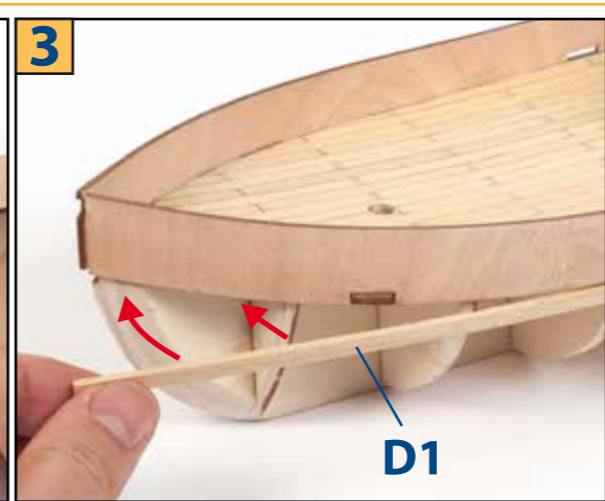
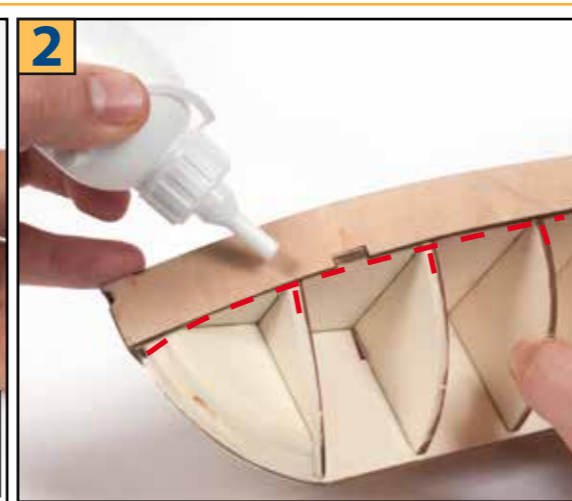
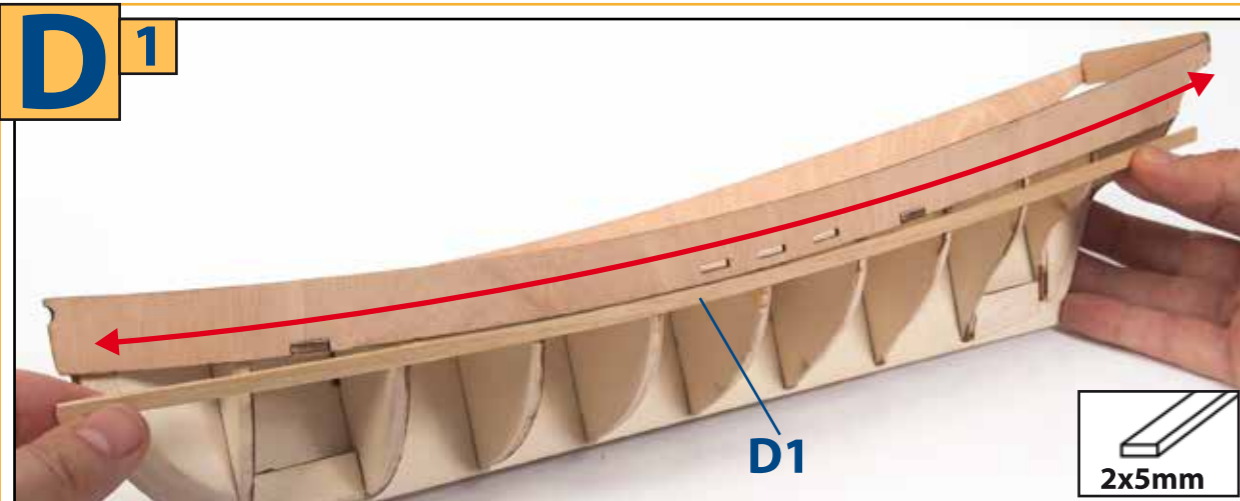

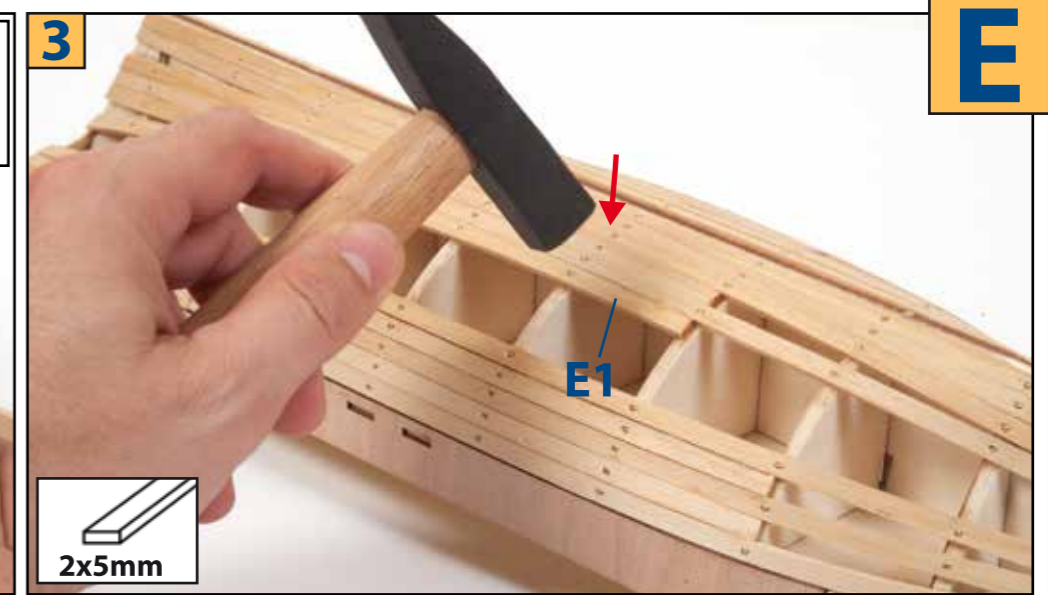
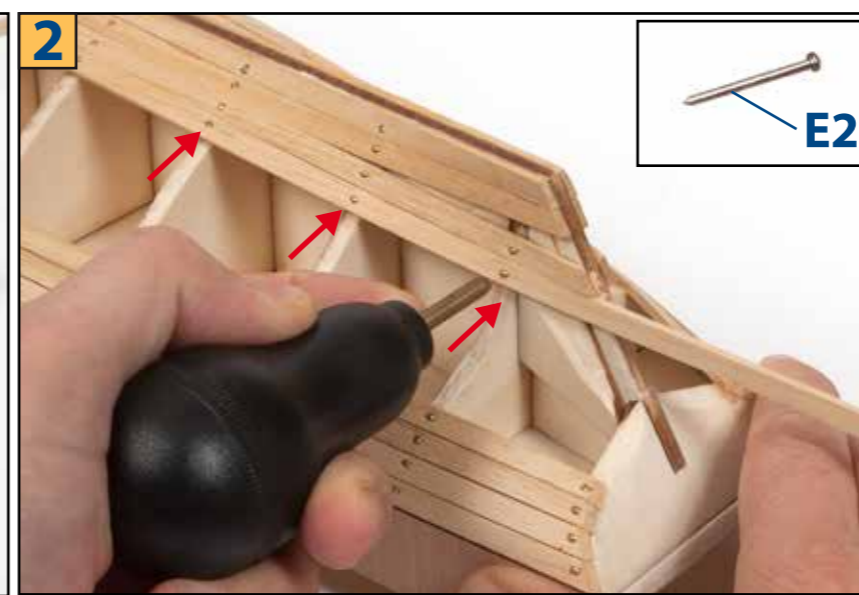
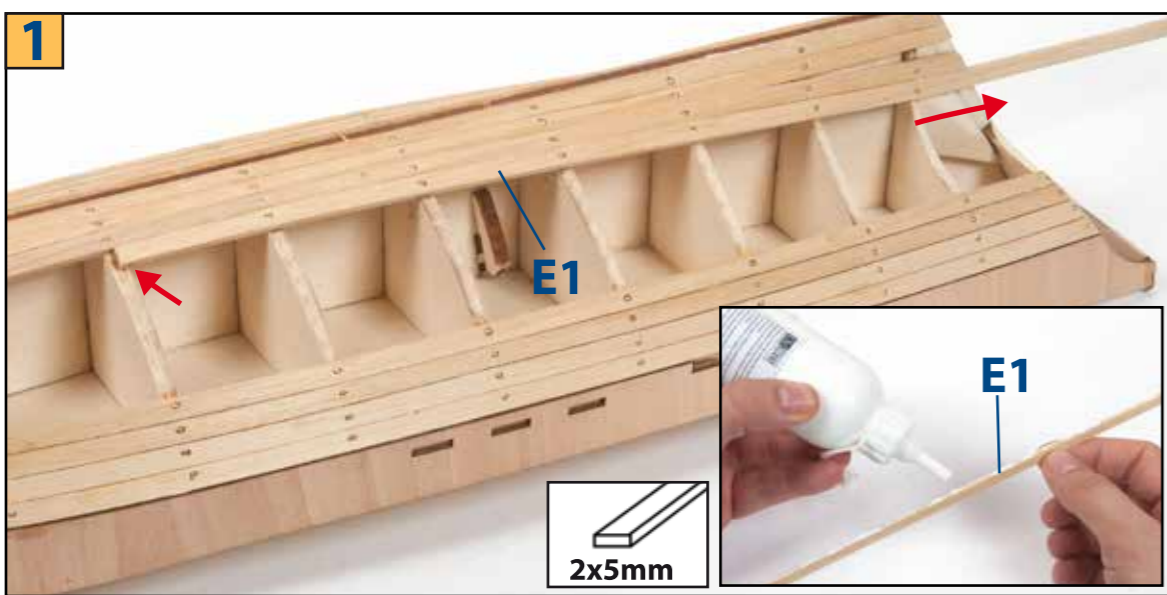

E



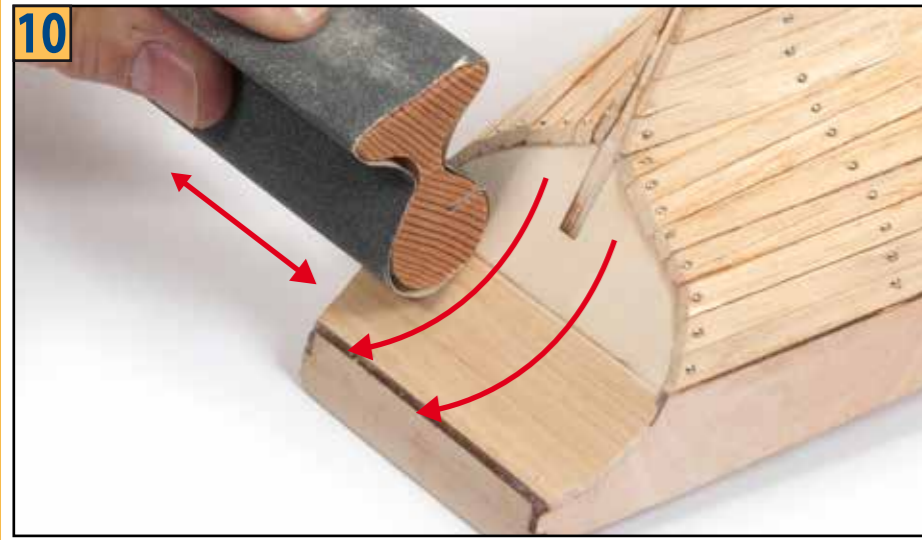
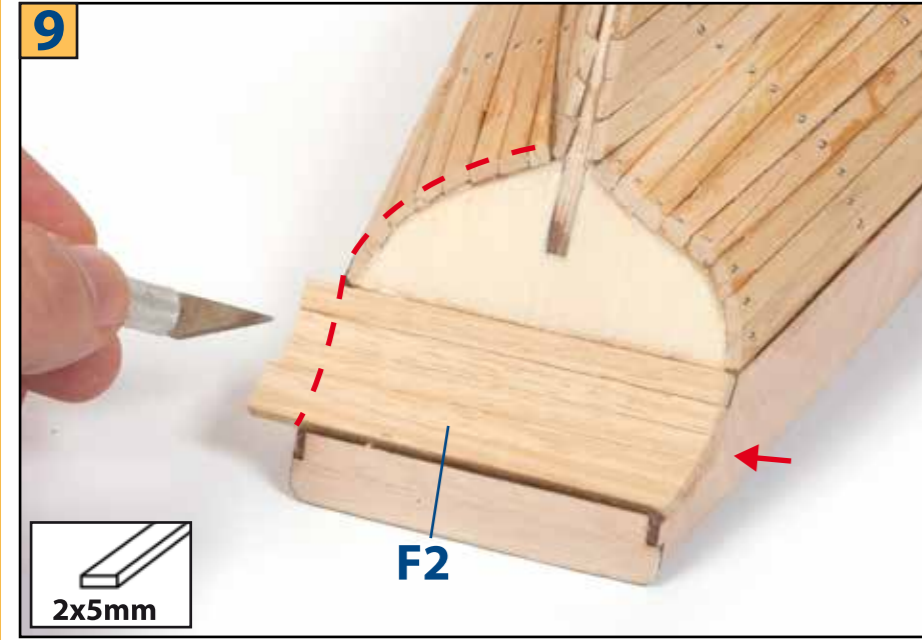
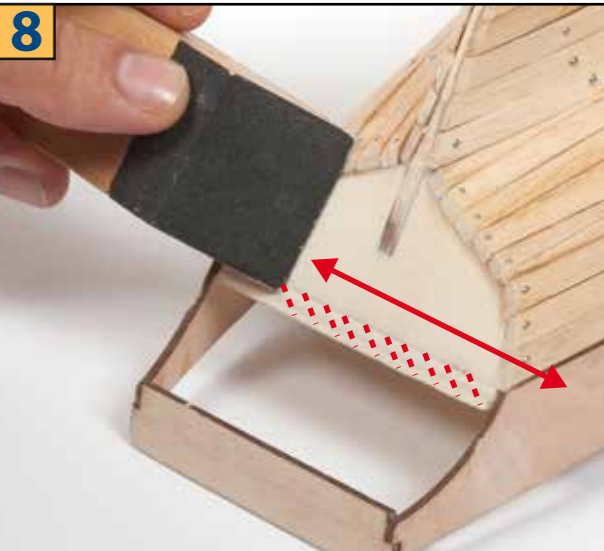
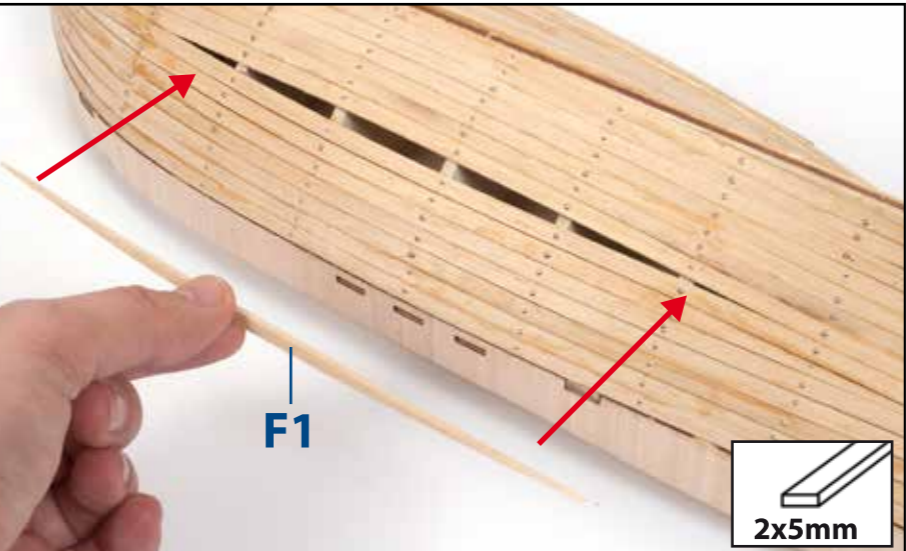
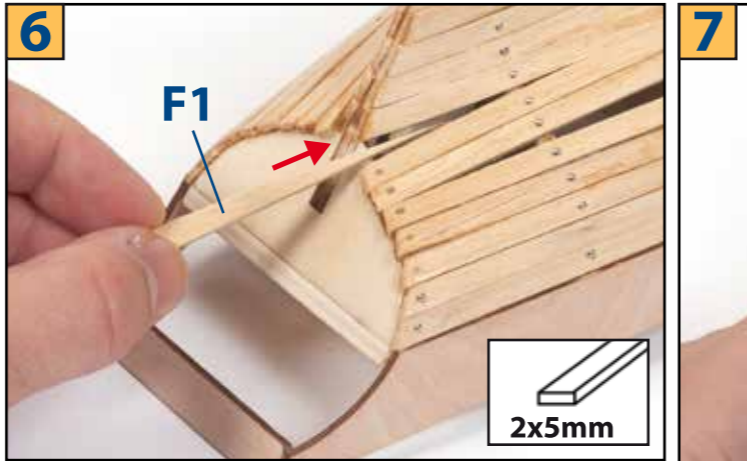
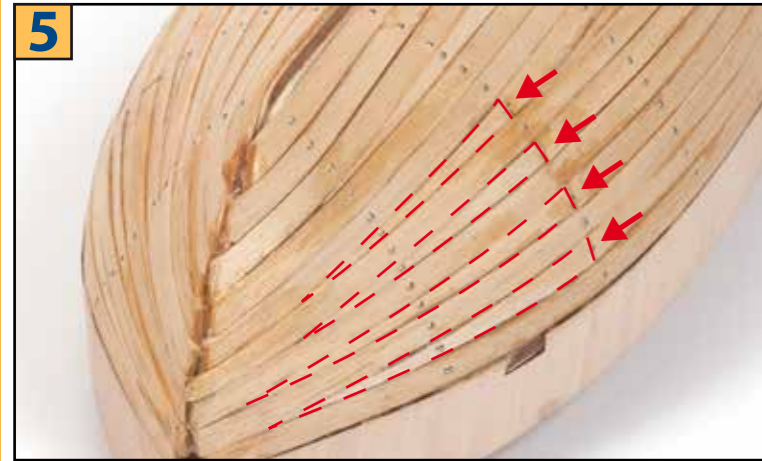
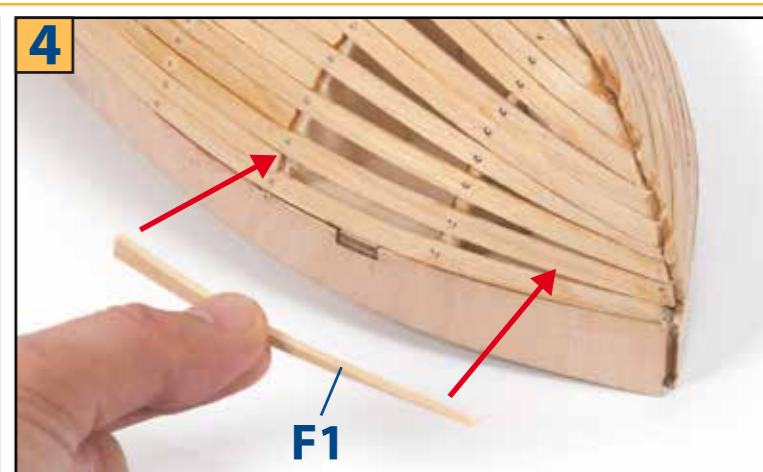
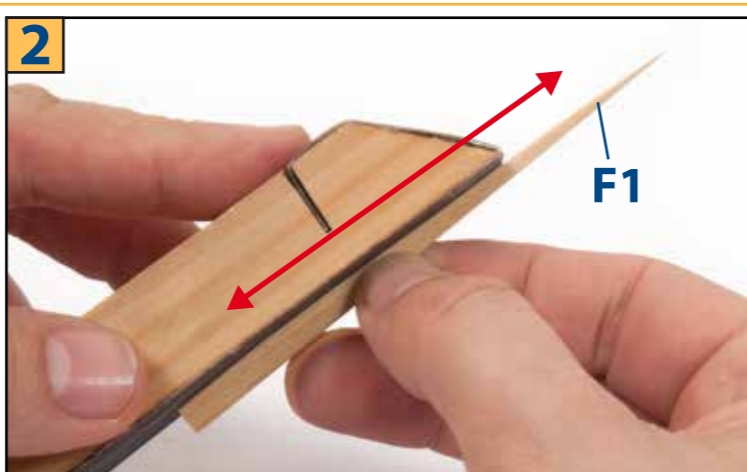
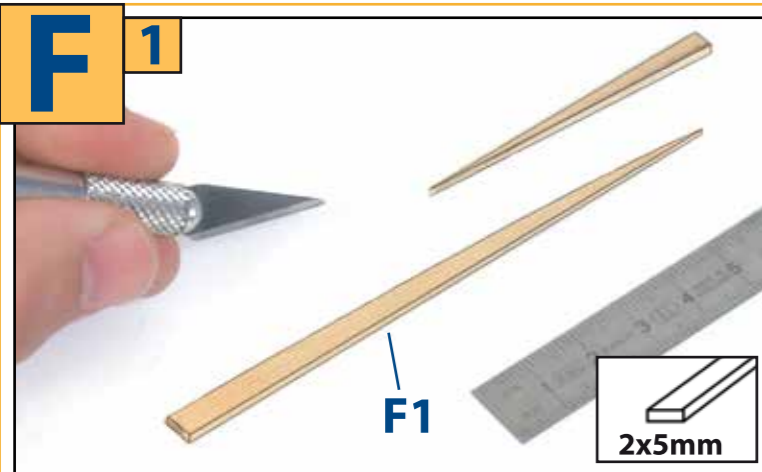

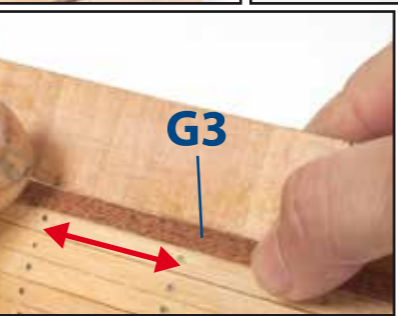
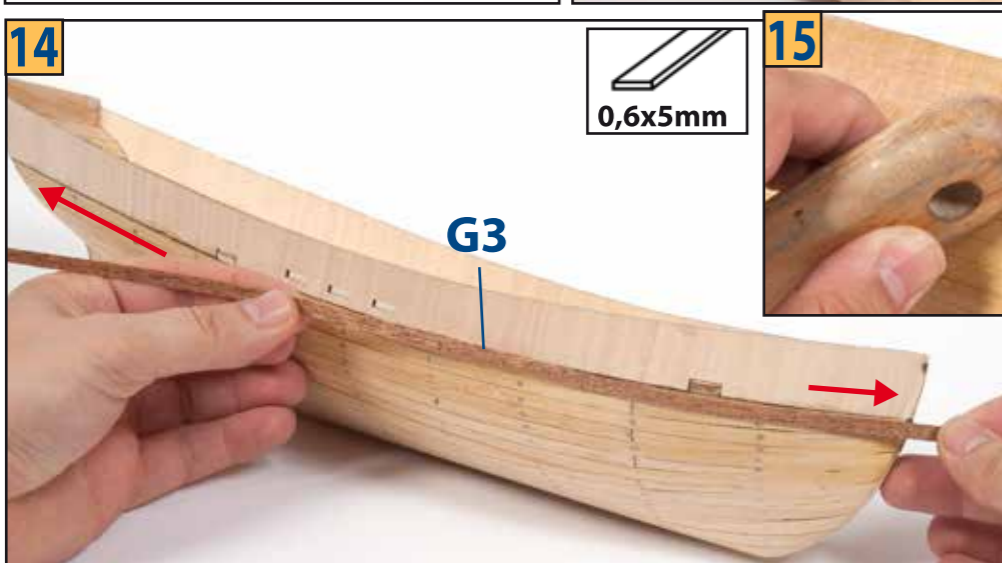
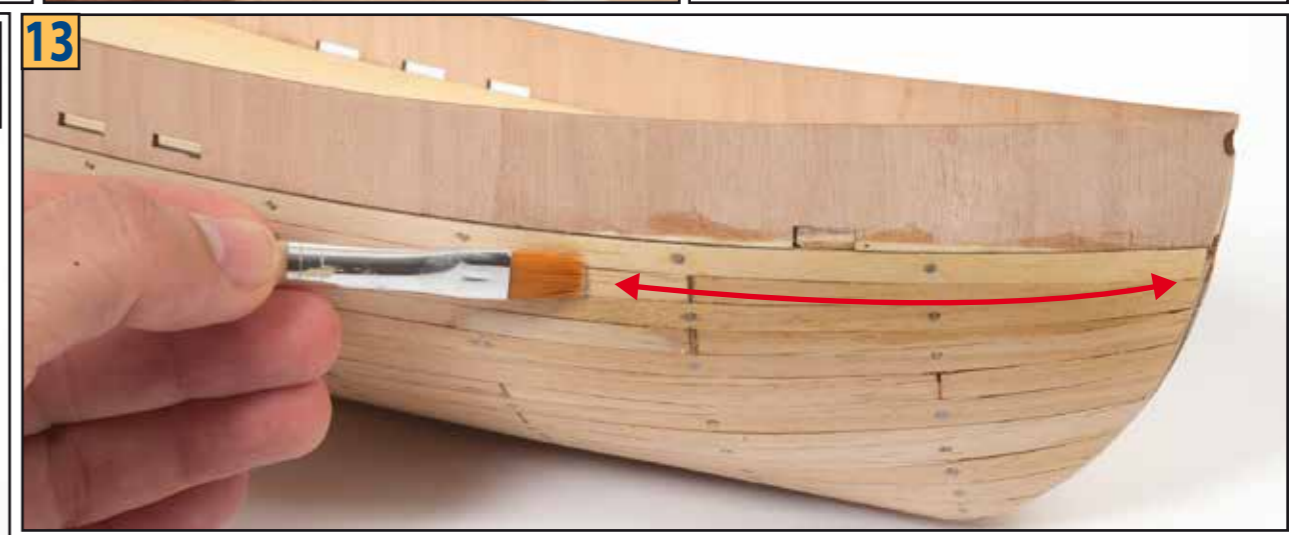
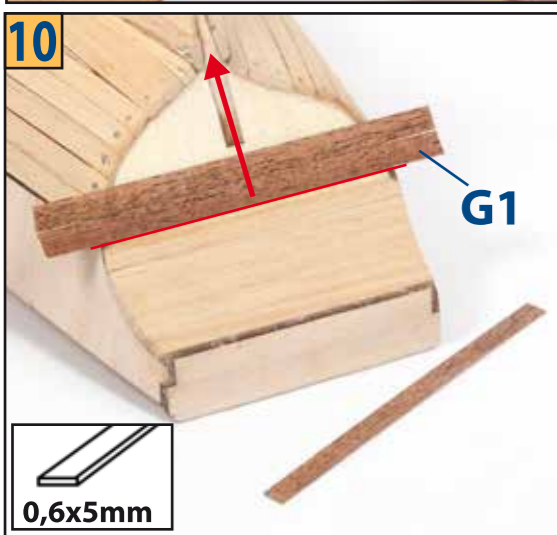
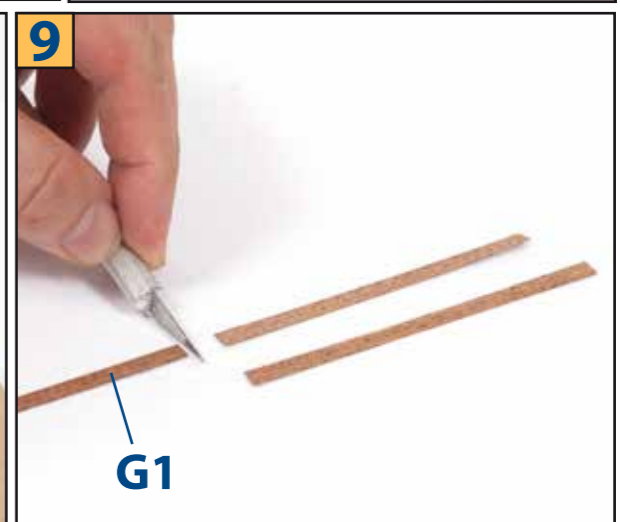
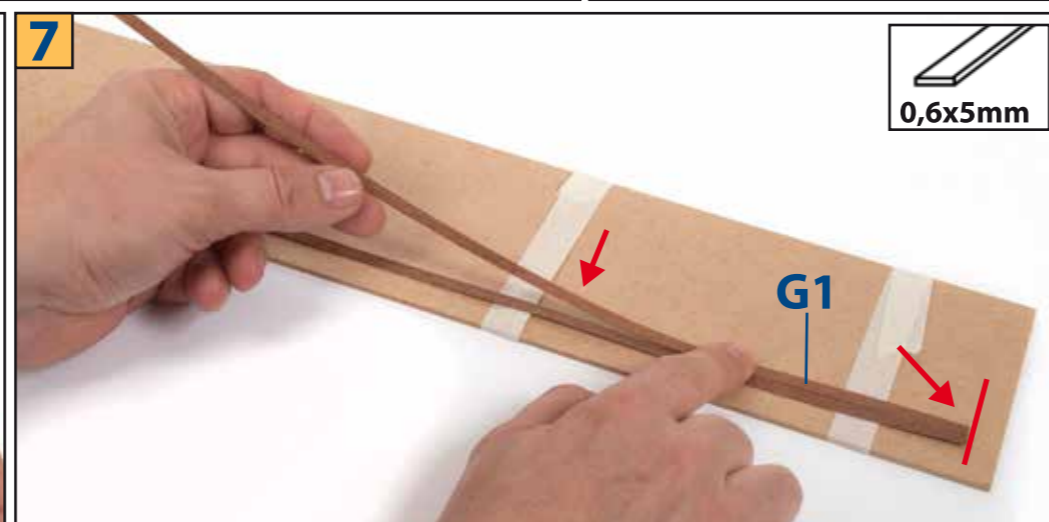
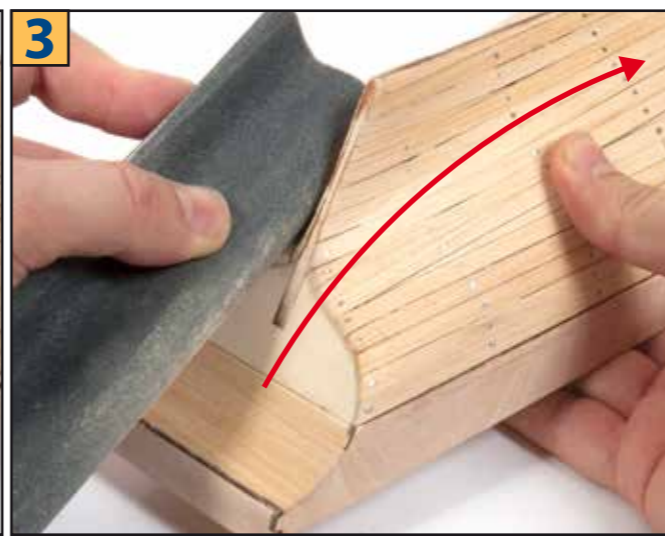
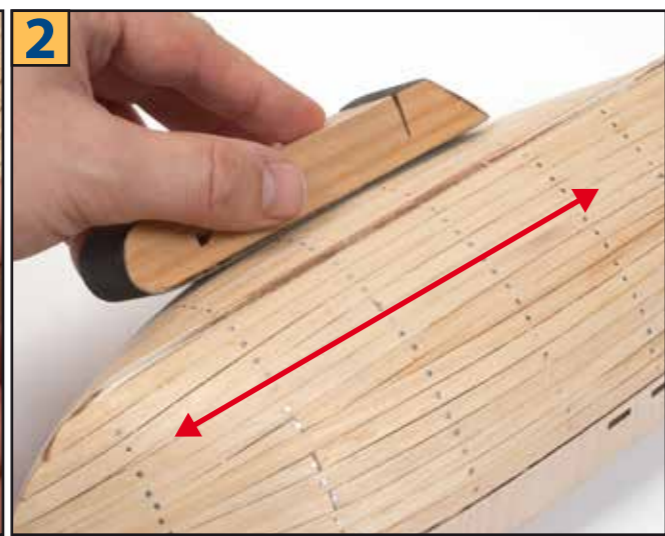
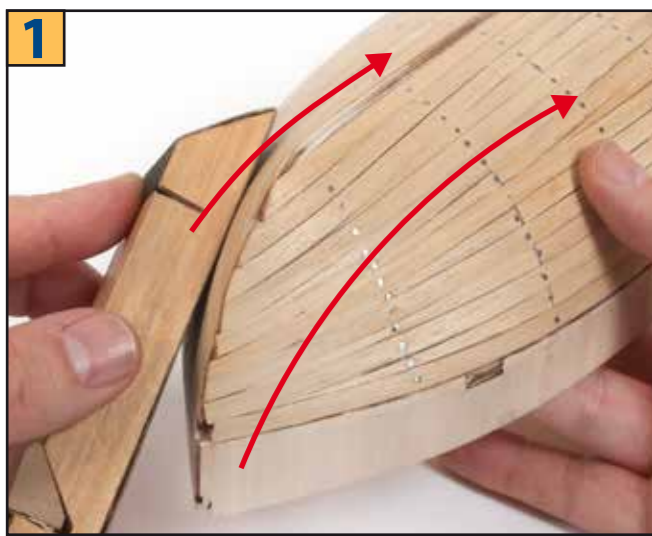

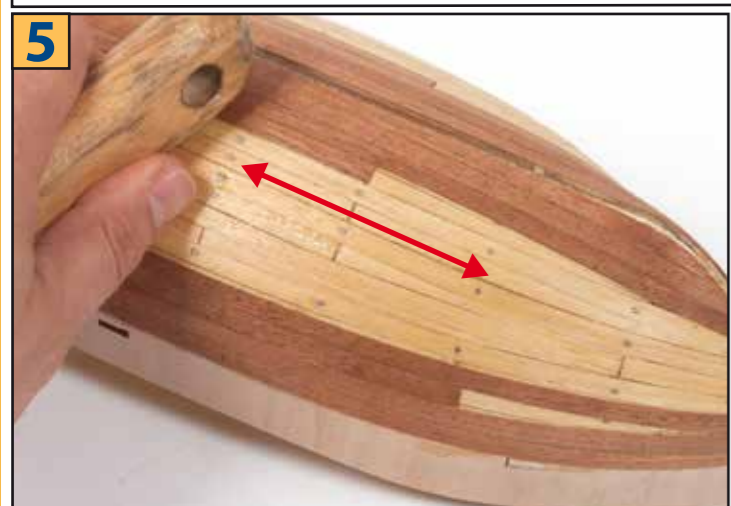
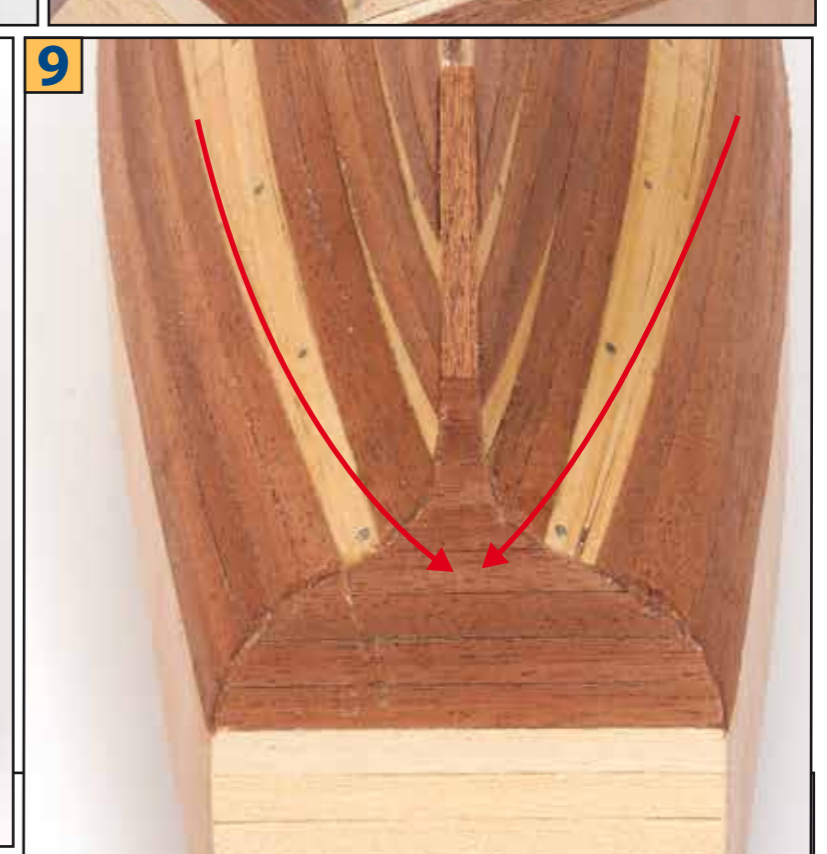
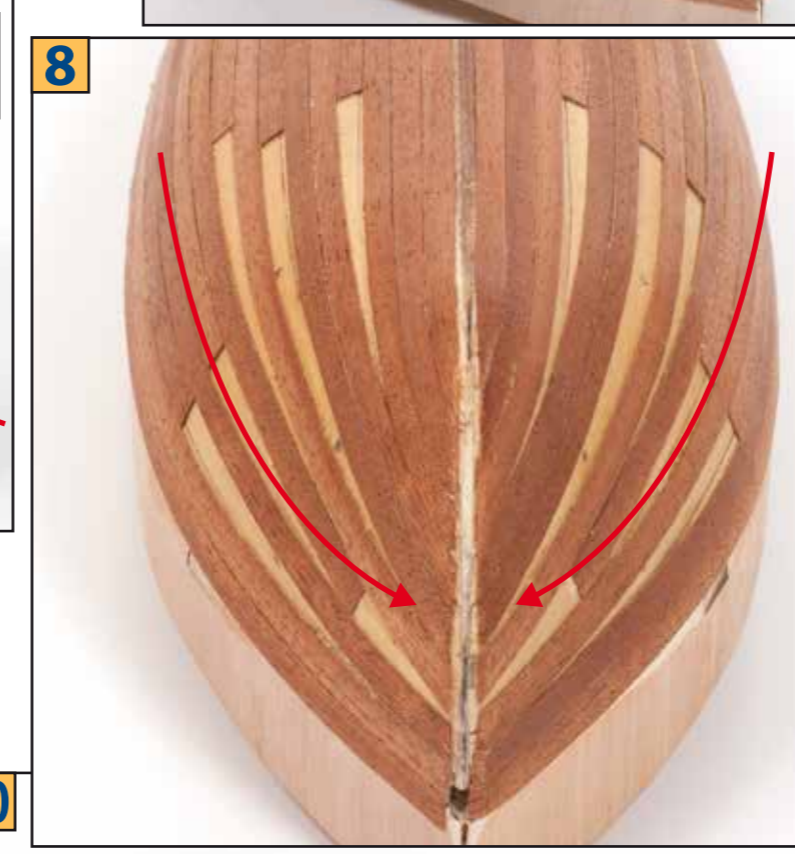
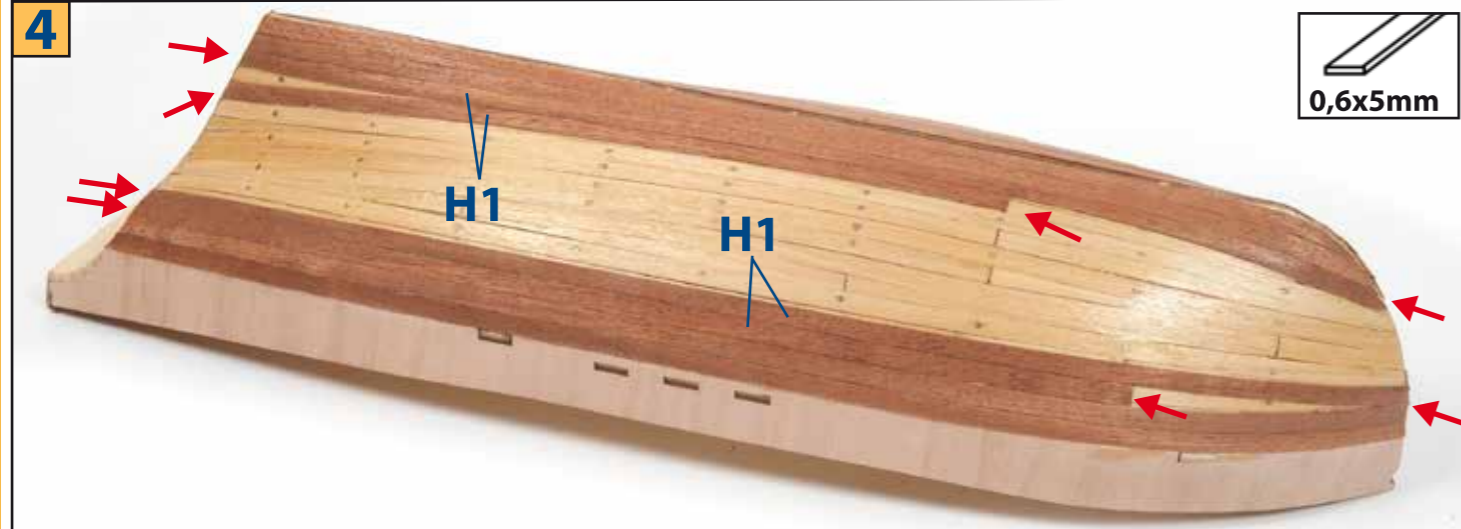
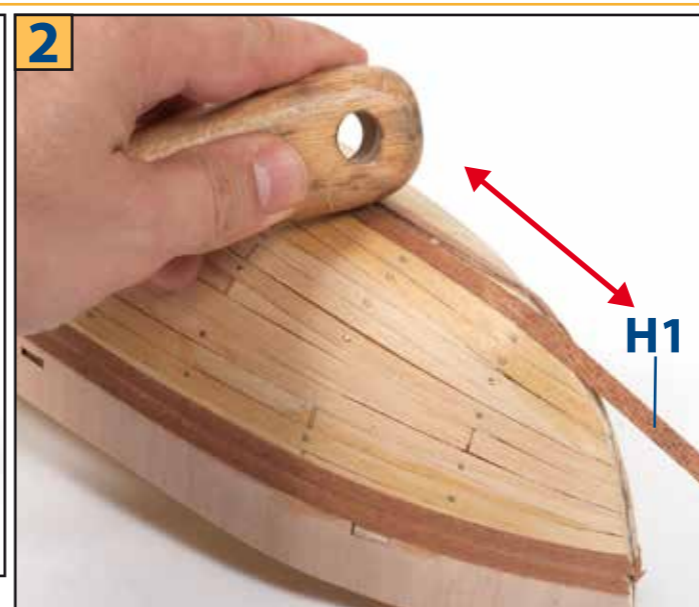
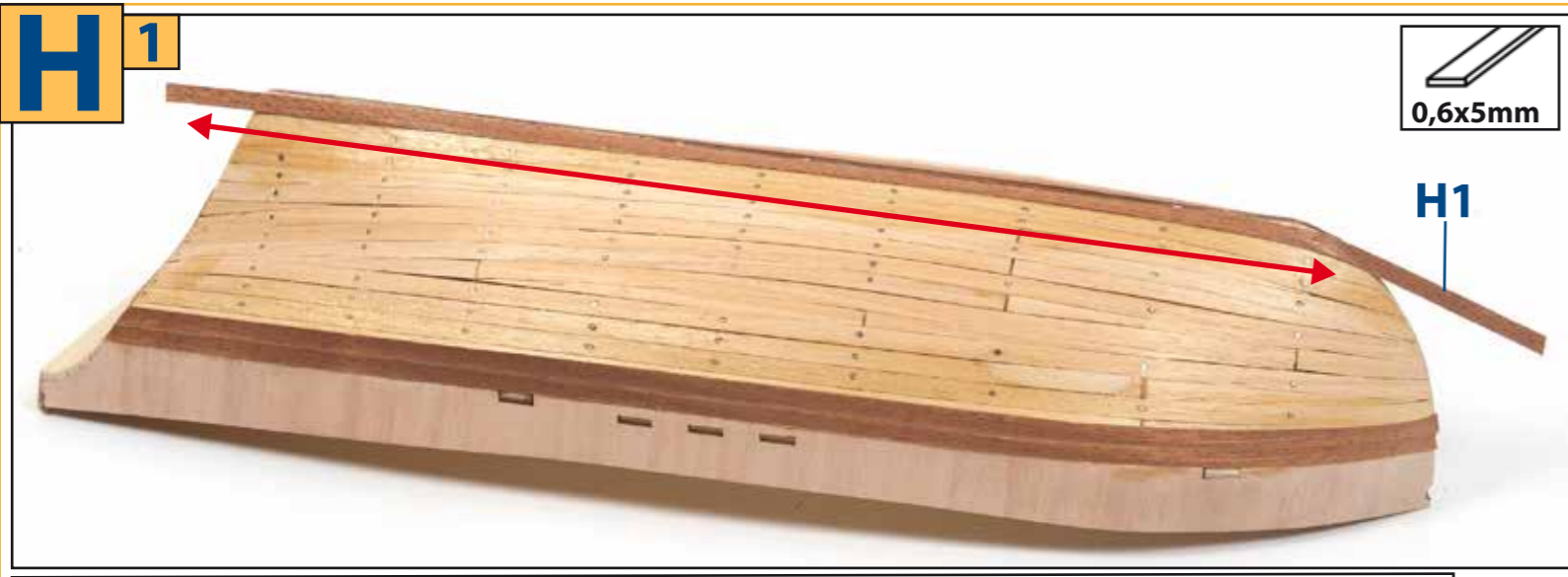

10



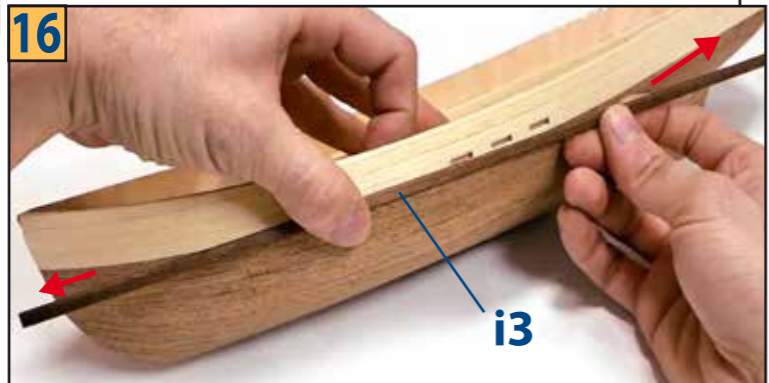
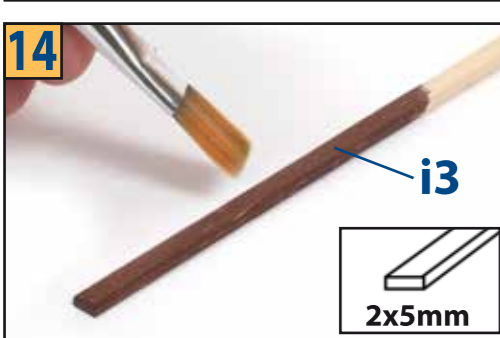
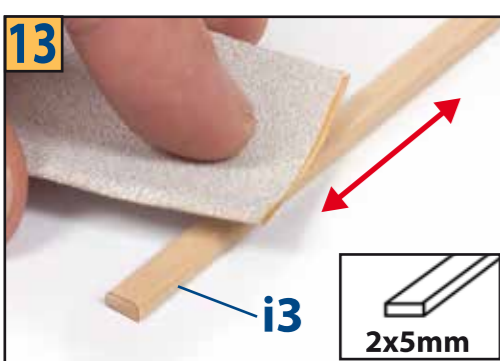
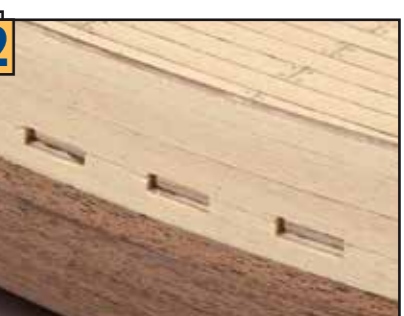
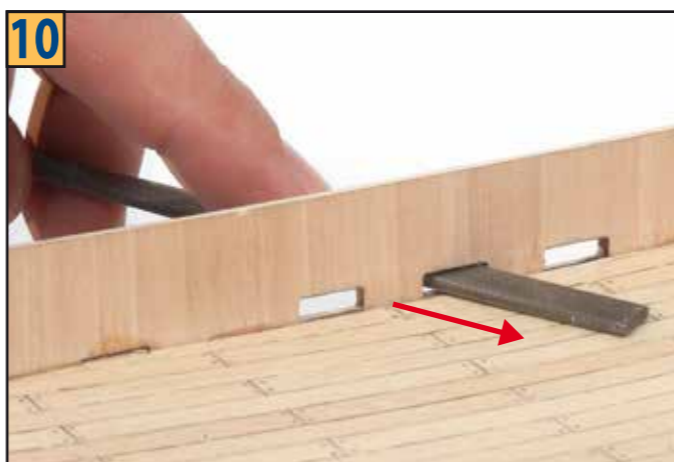
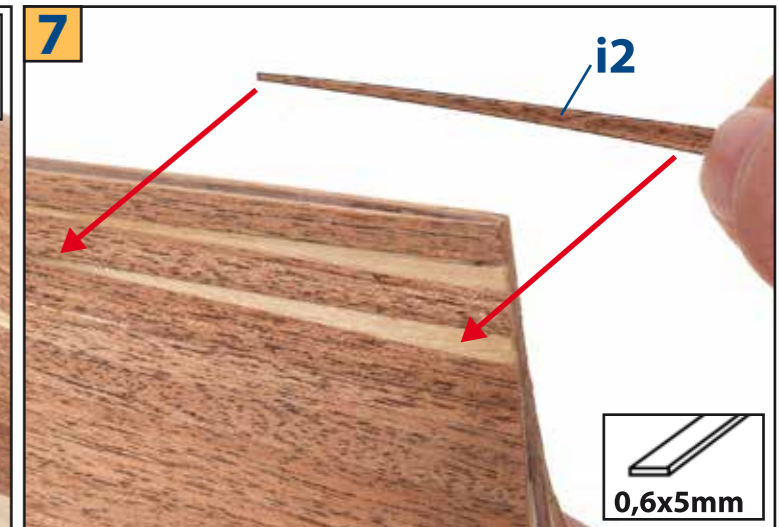
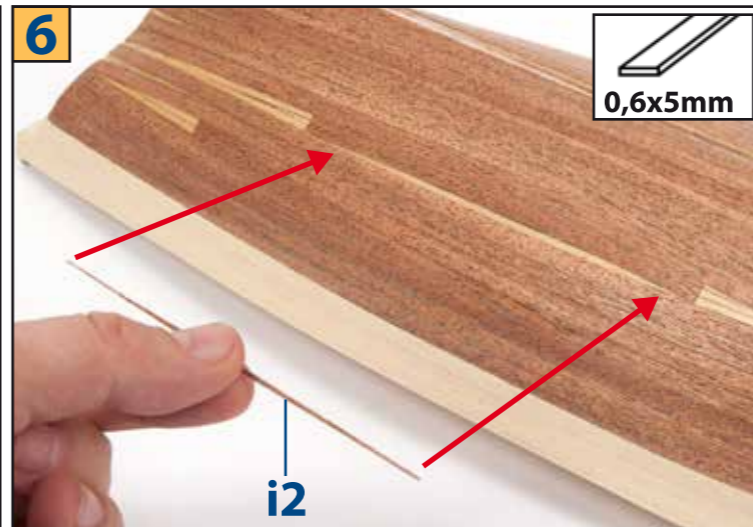
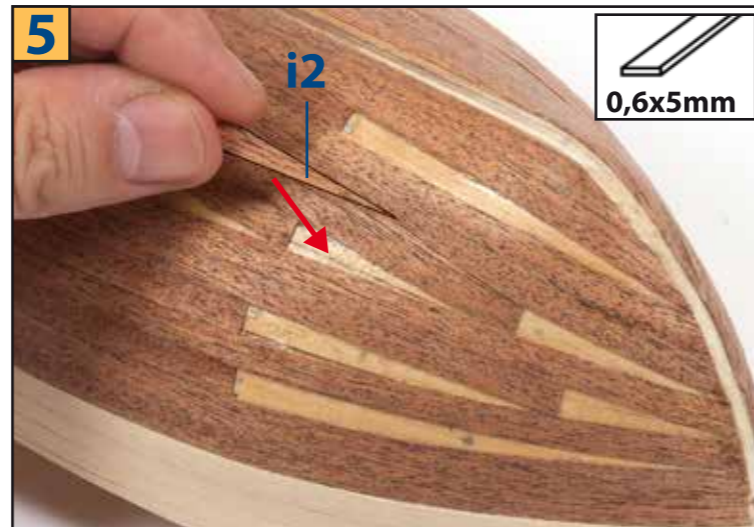
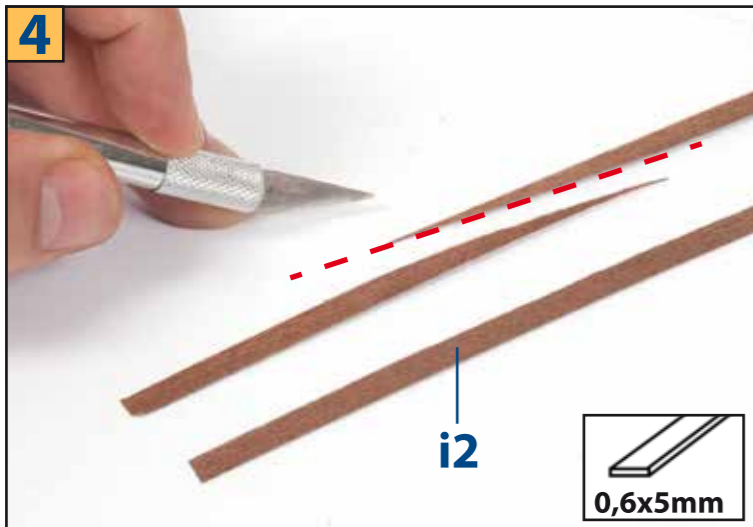
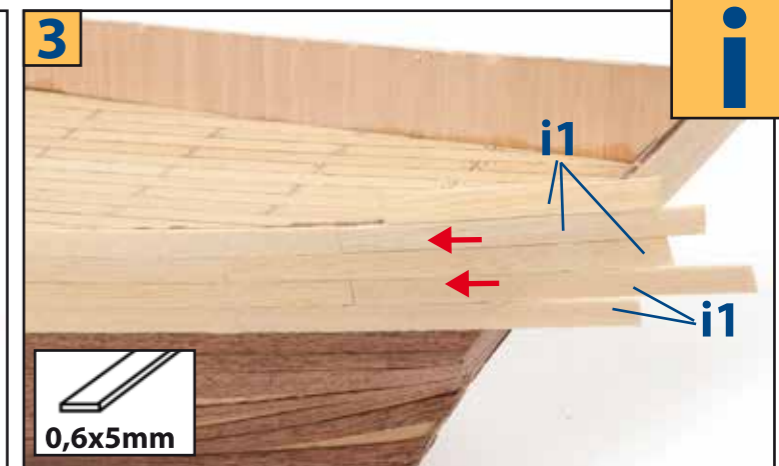
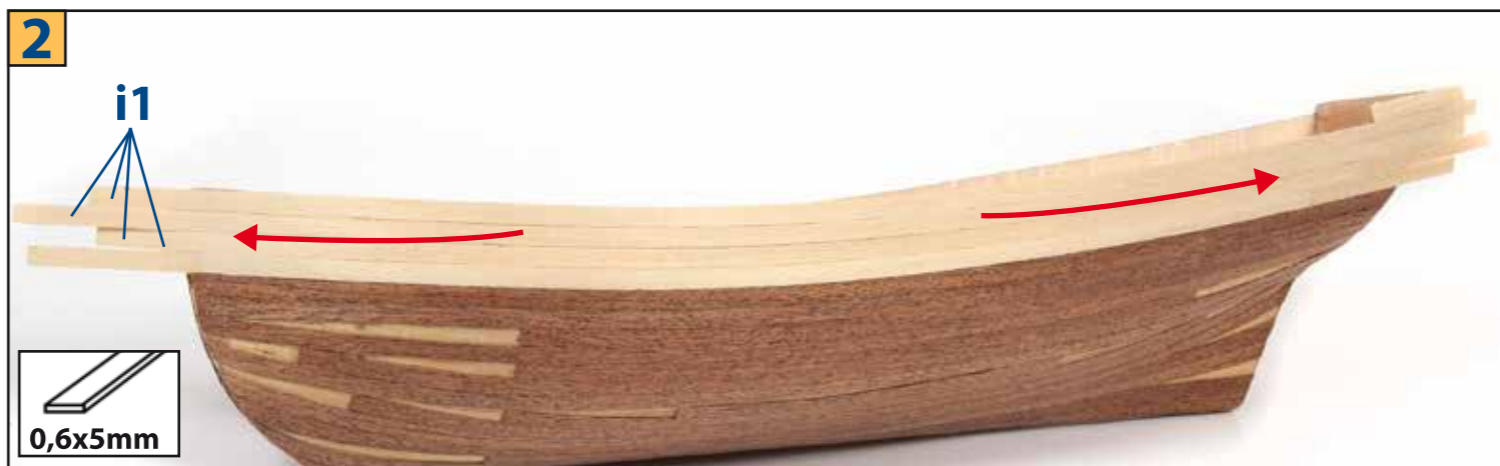
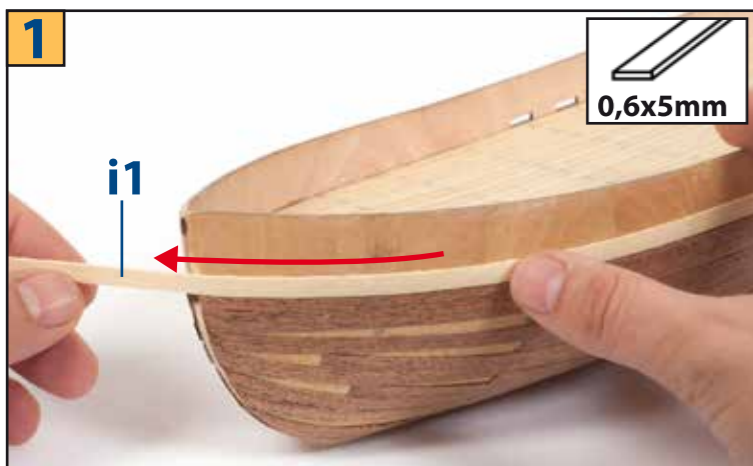

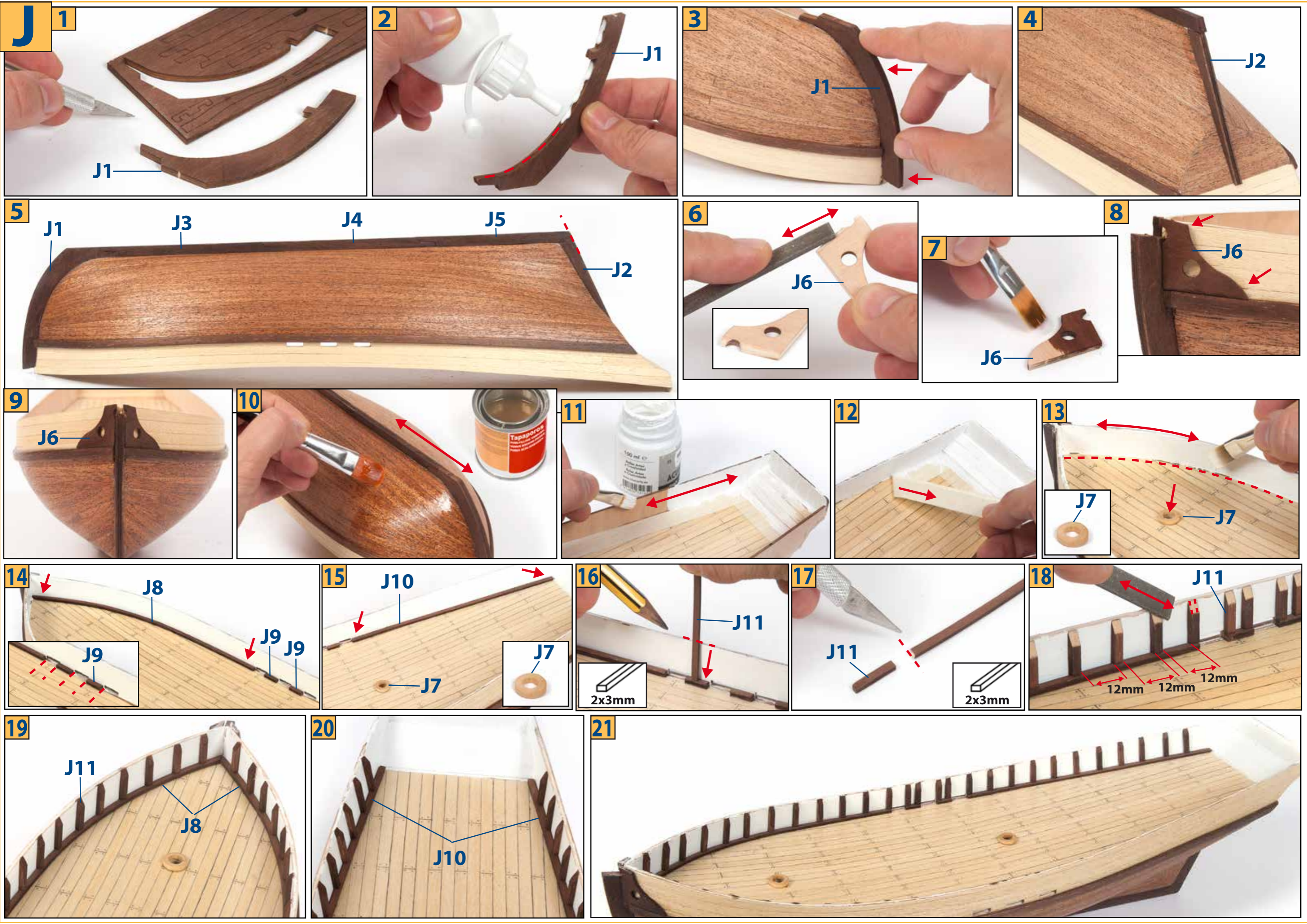

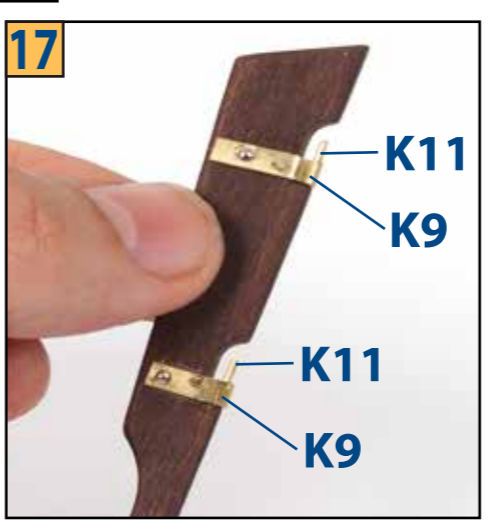
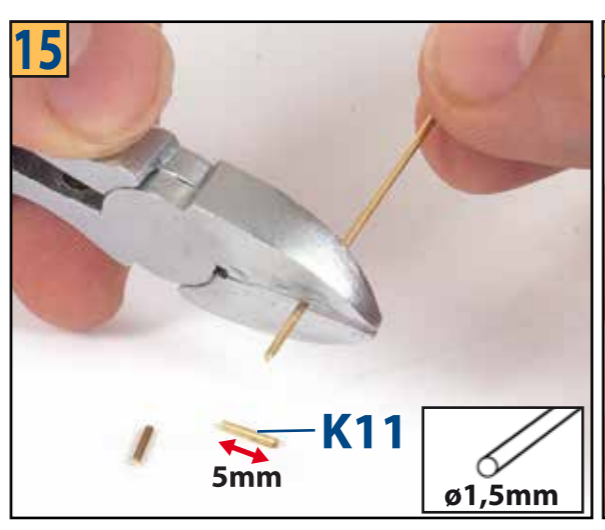
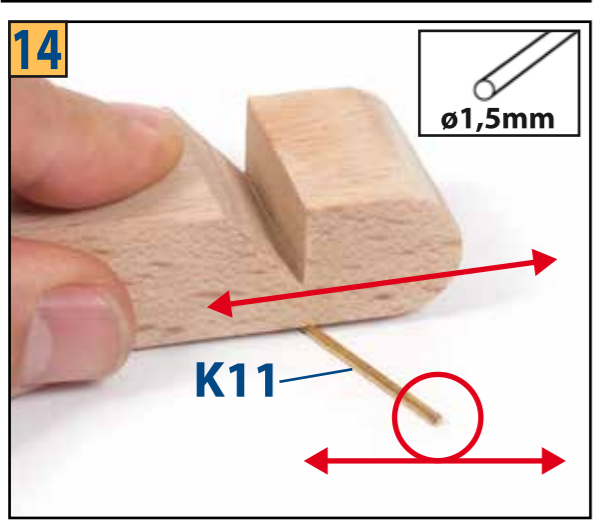
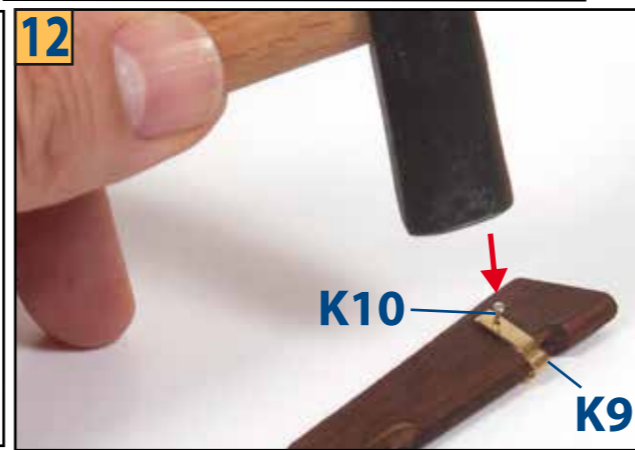
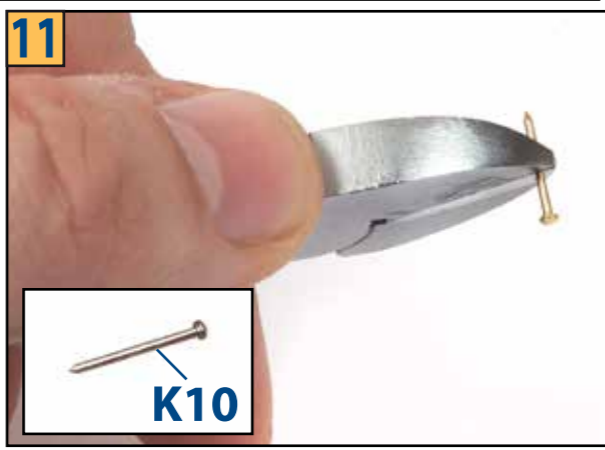
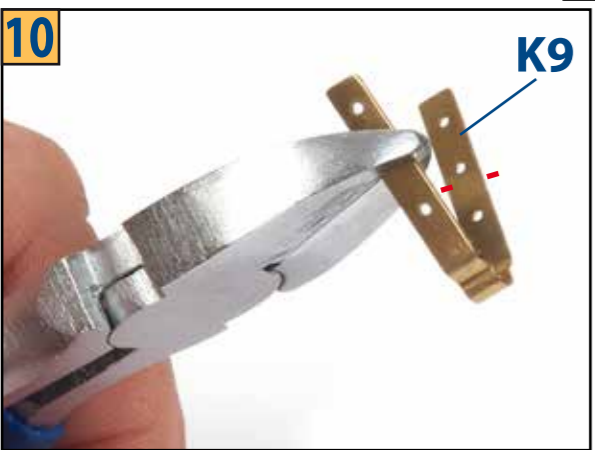
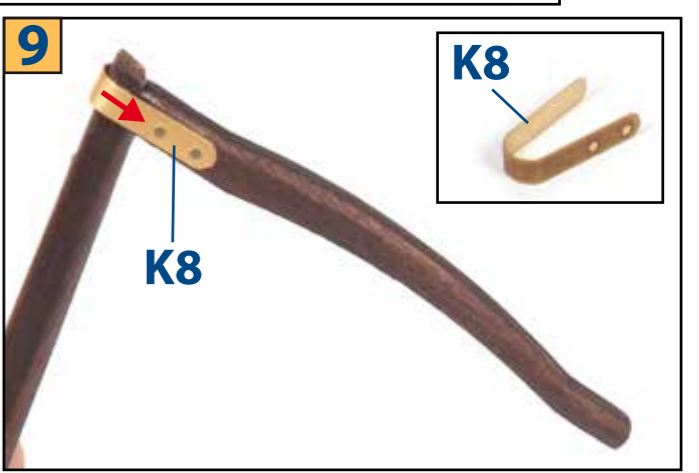
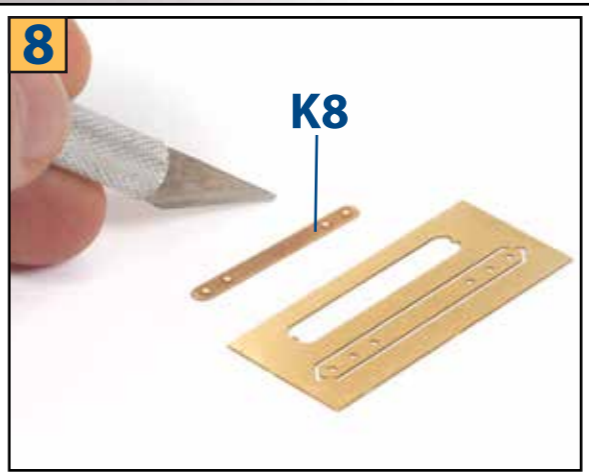
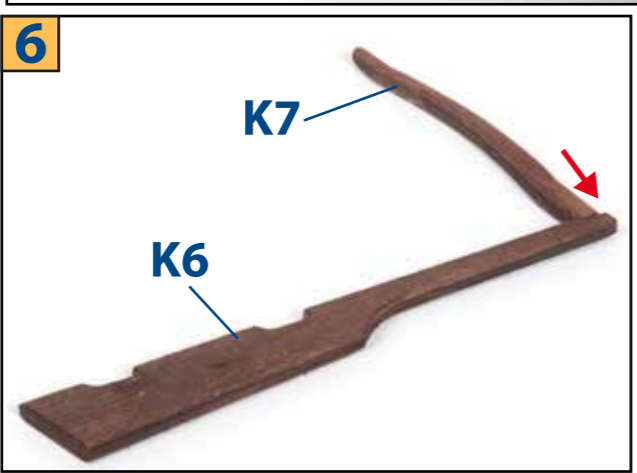
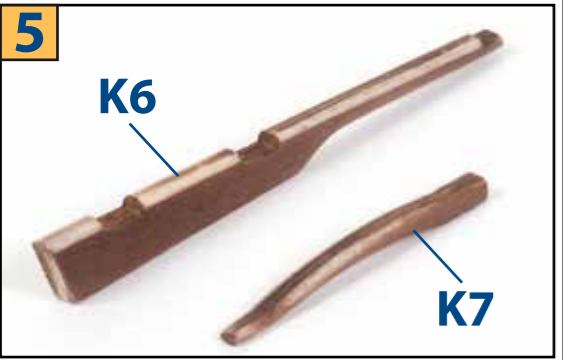
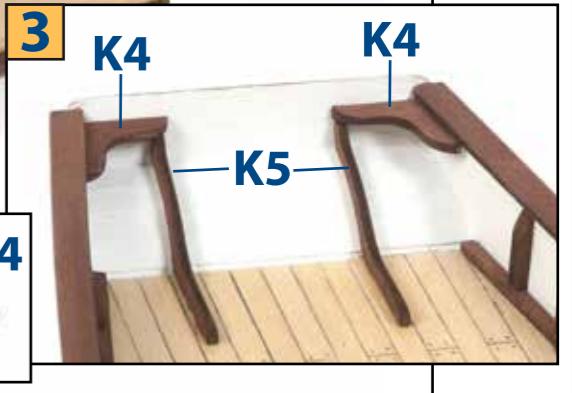
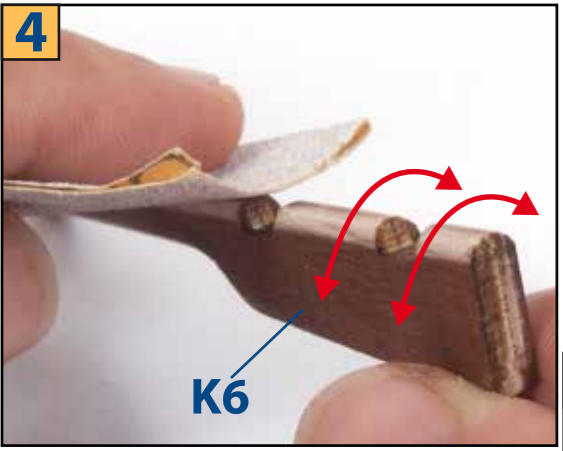
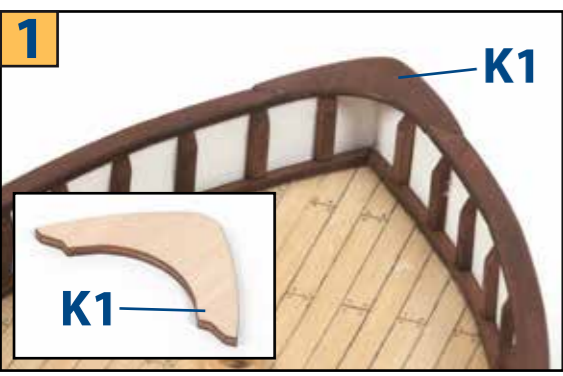

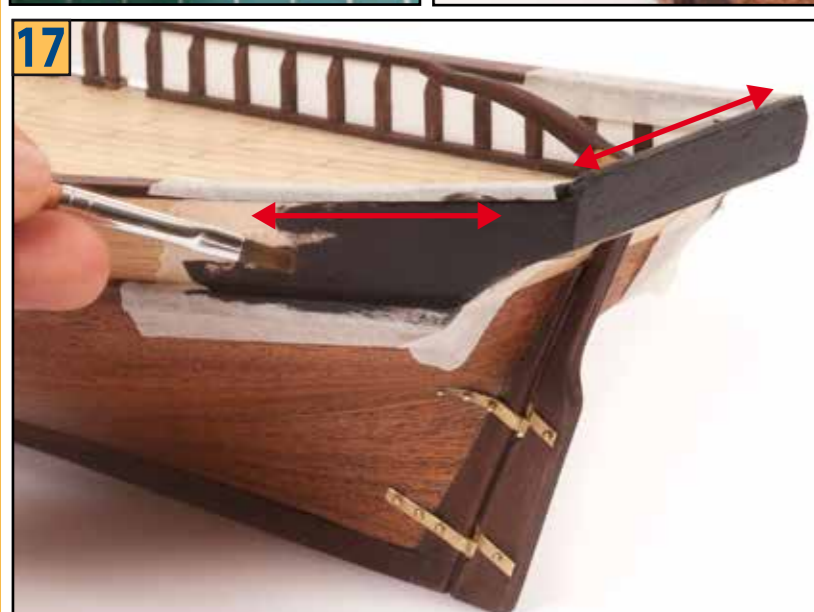
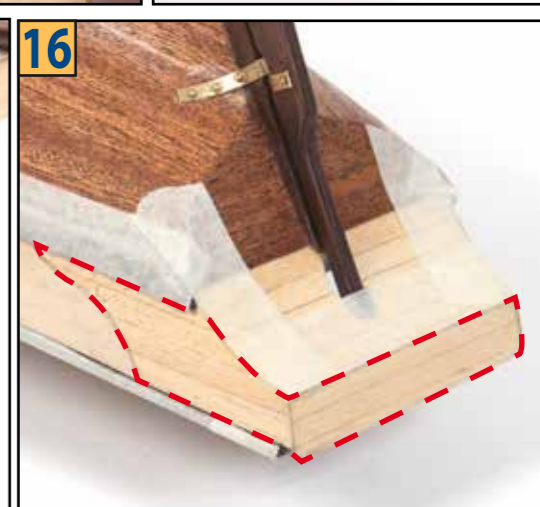
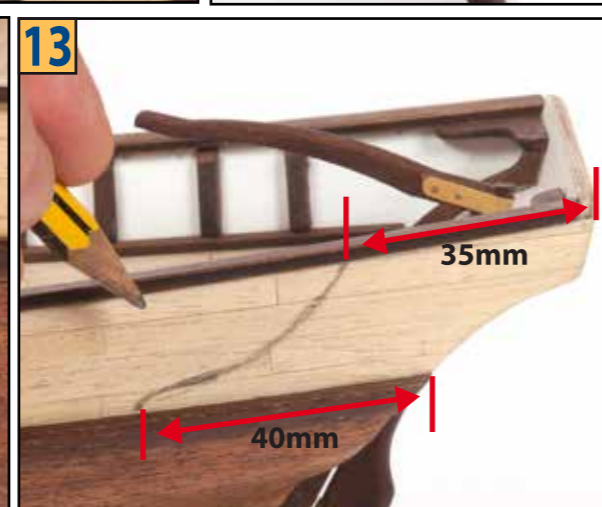
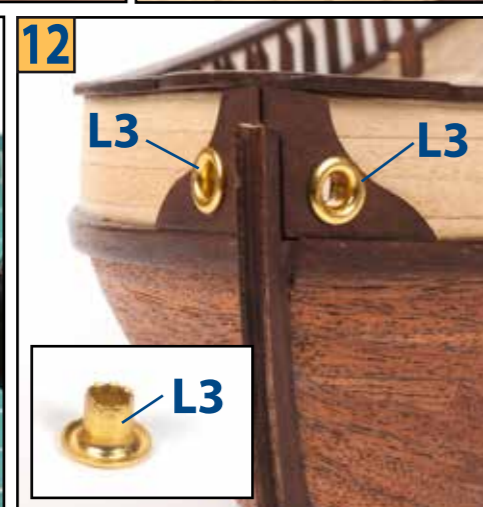
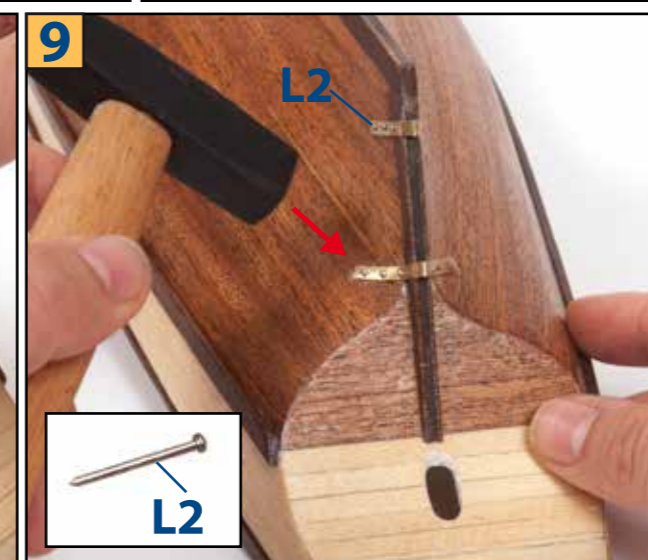
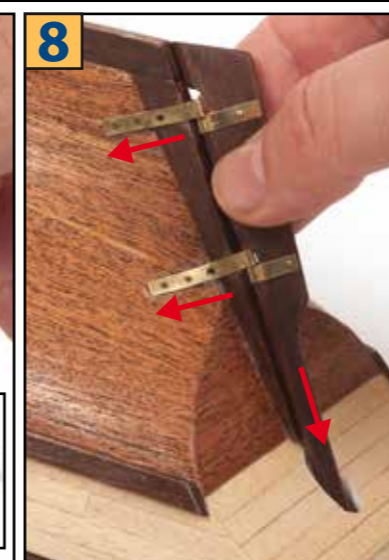
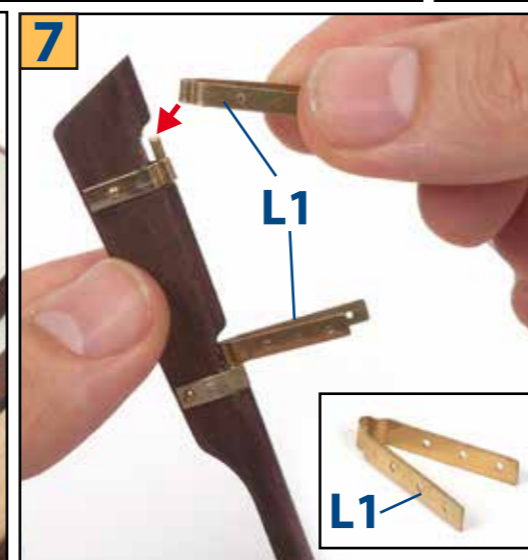
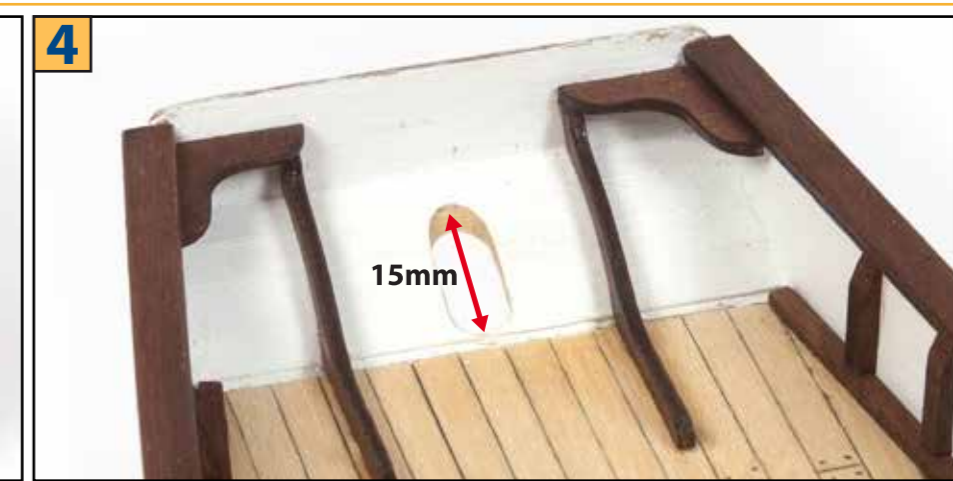
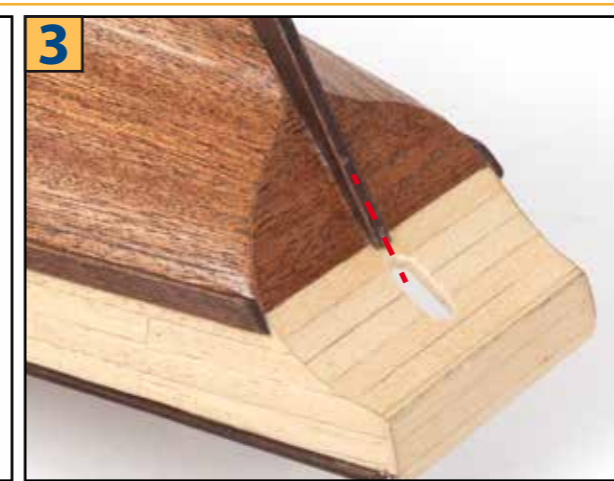
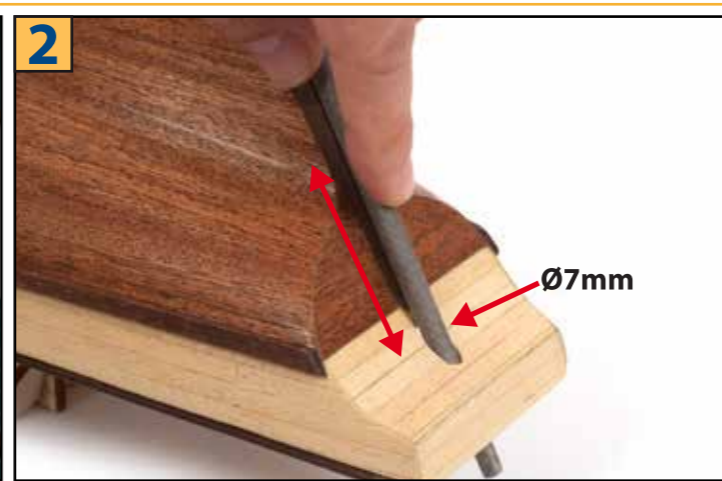

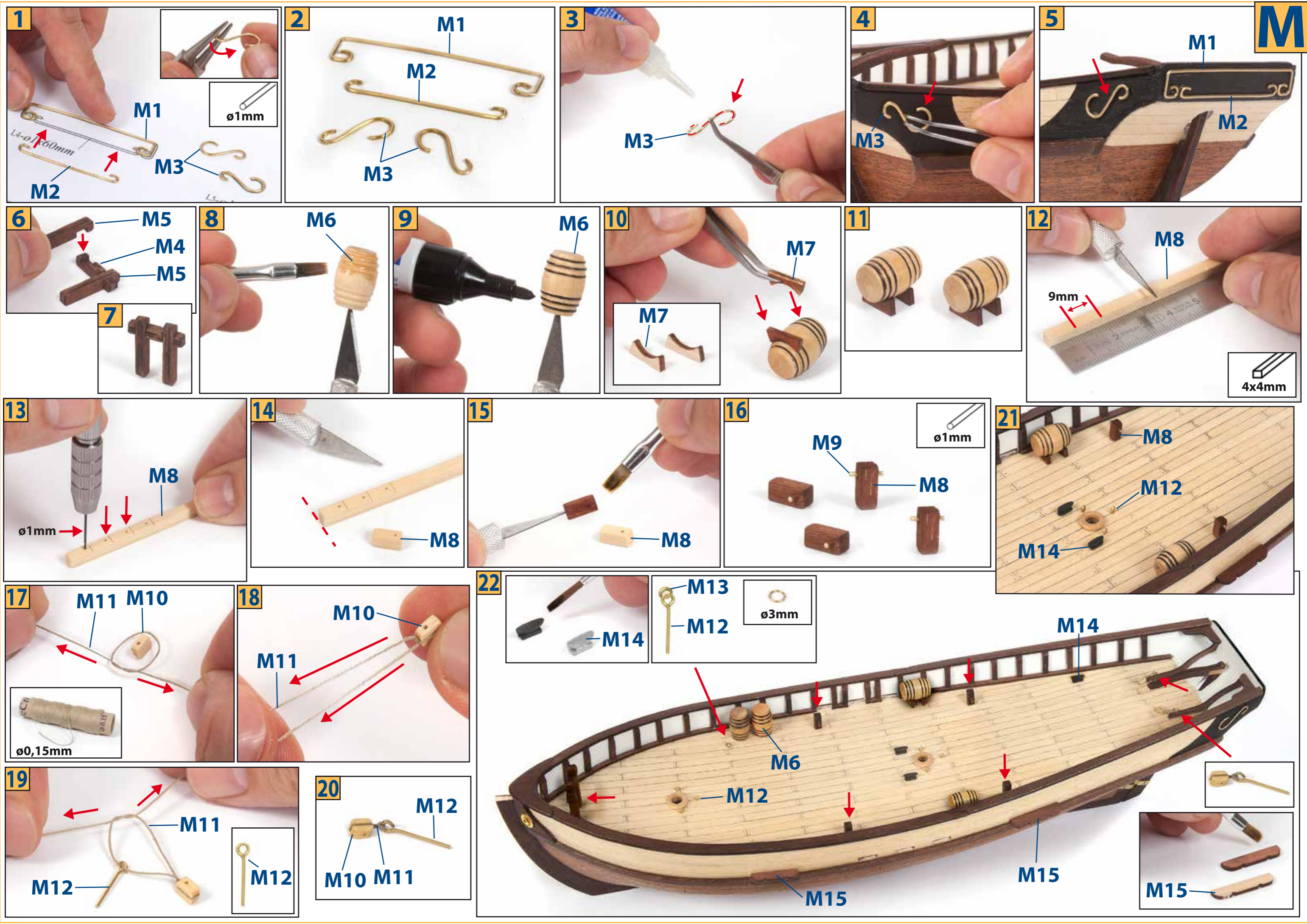

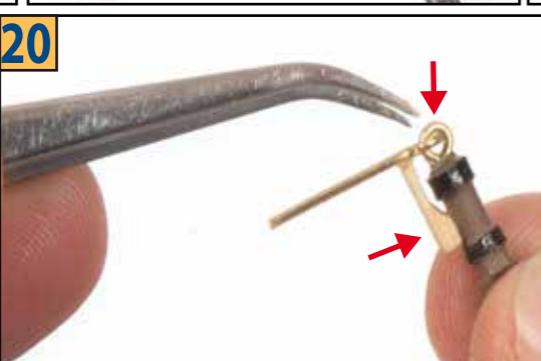
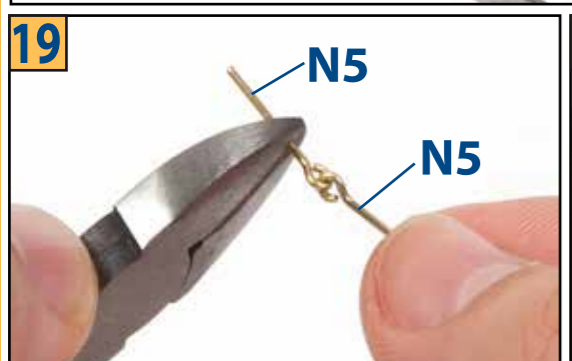
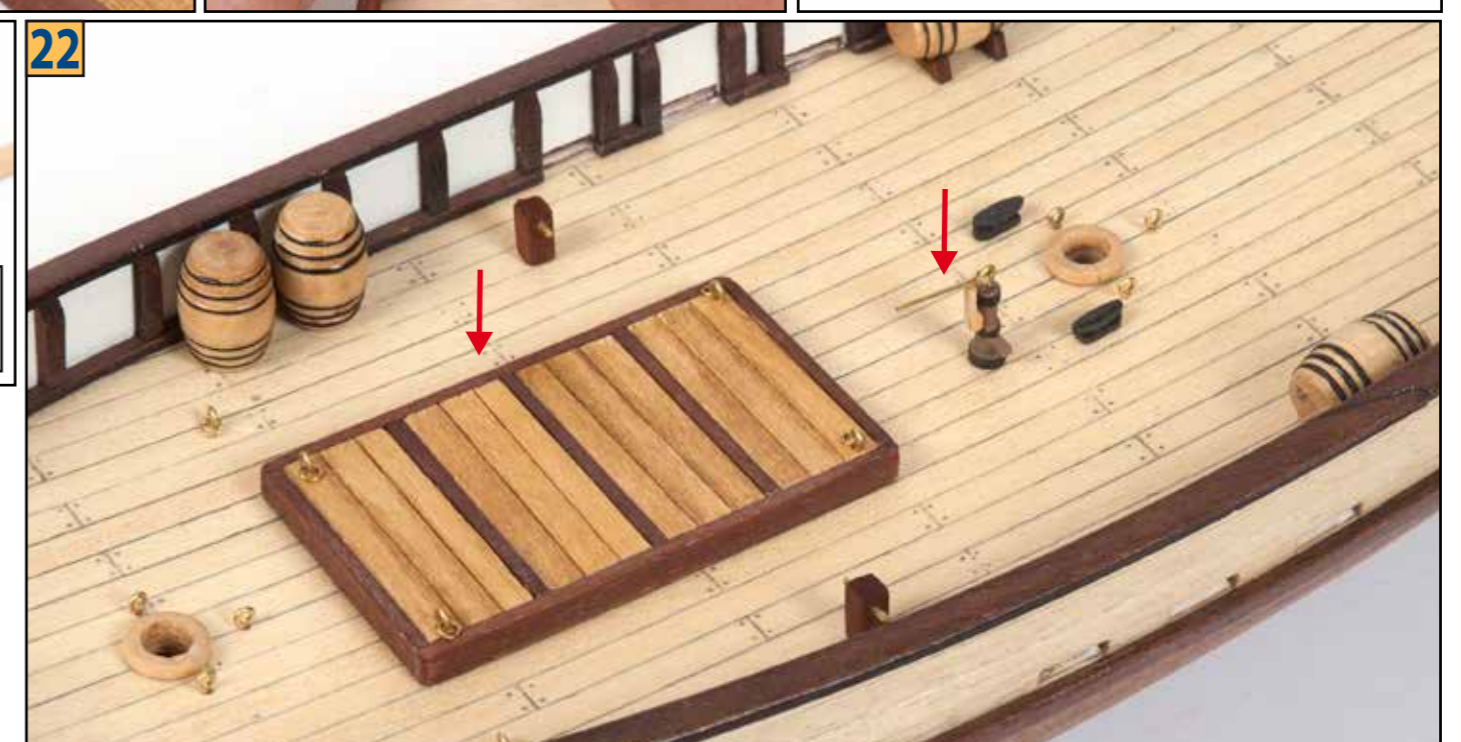
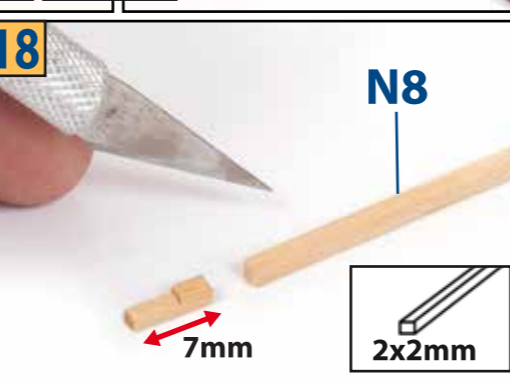
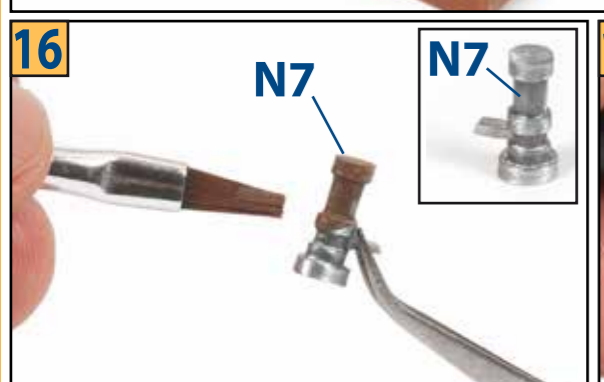
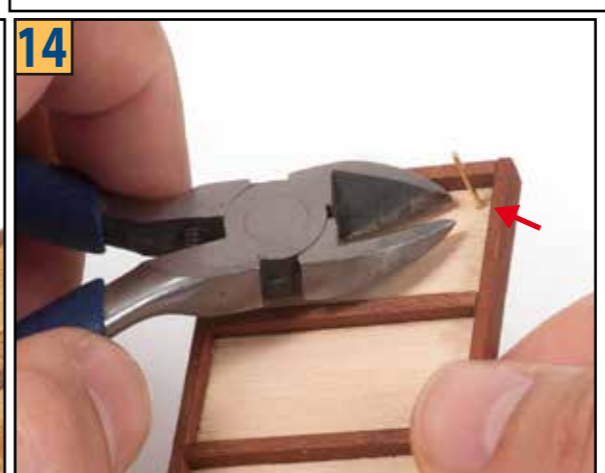
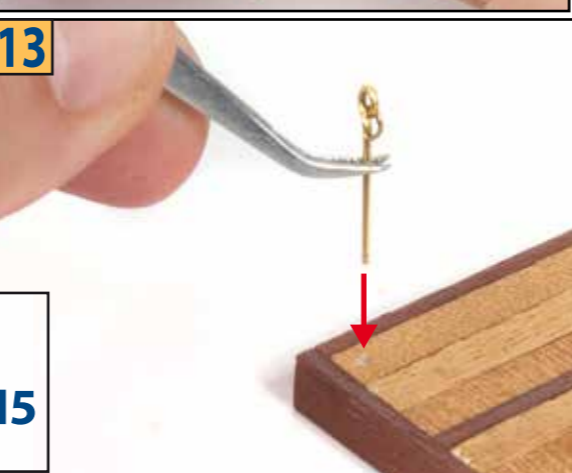
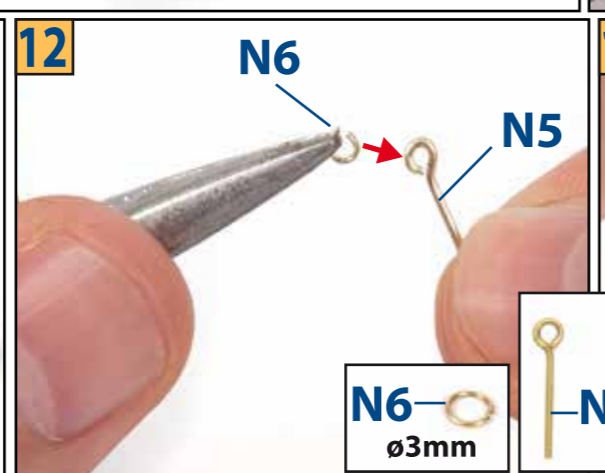
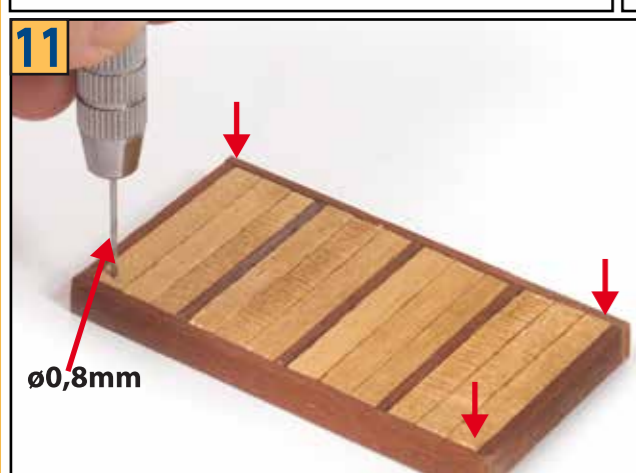
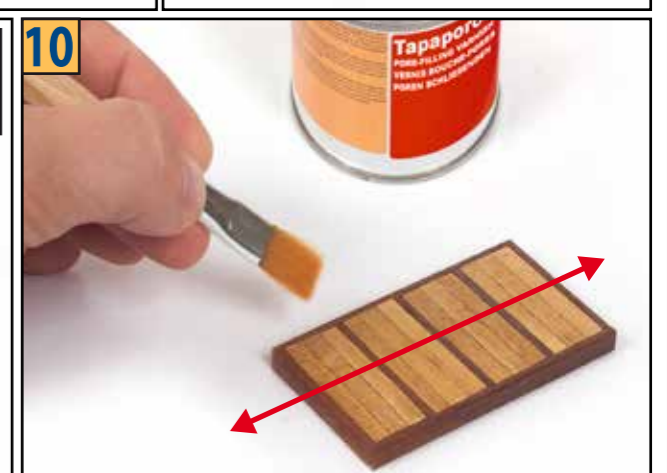
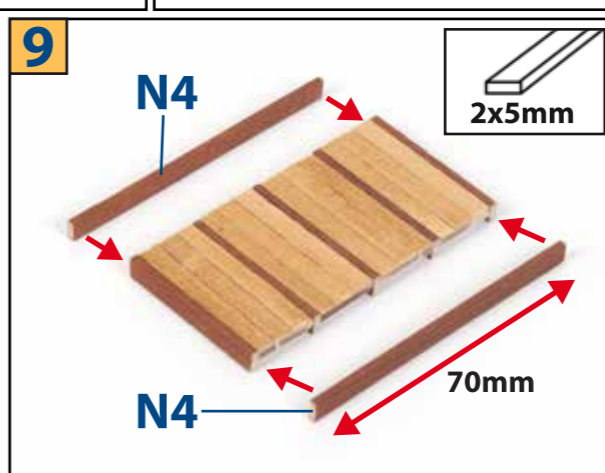
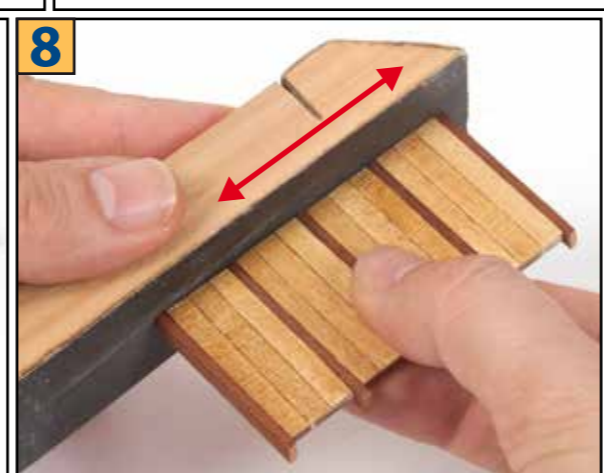
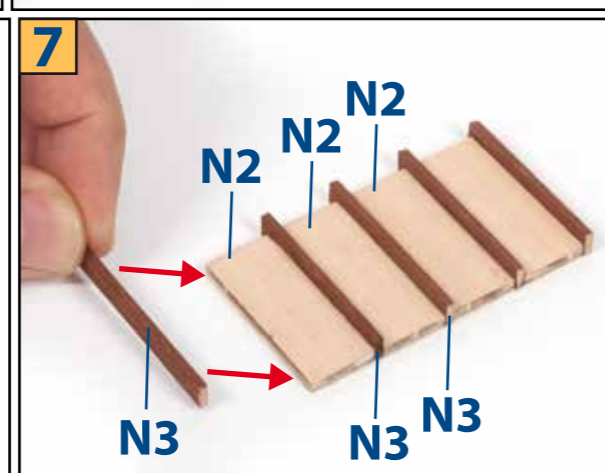
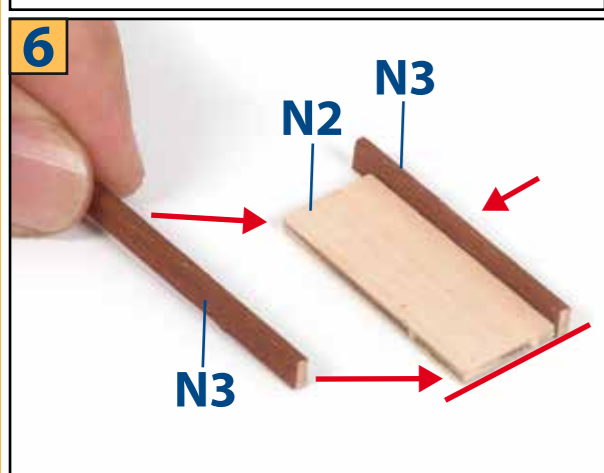
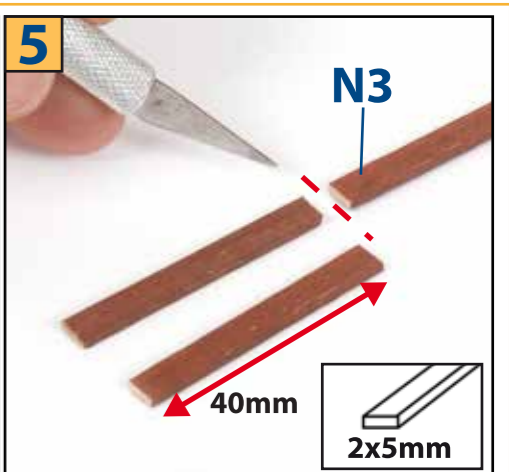
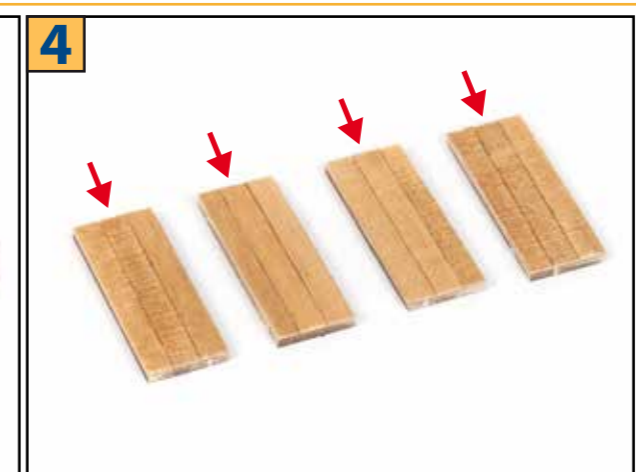
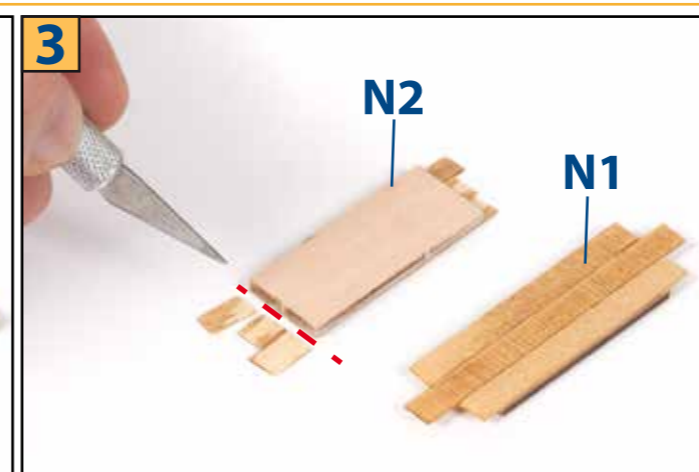
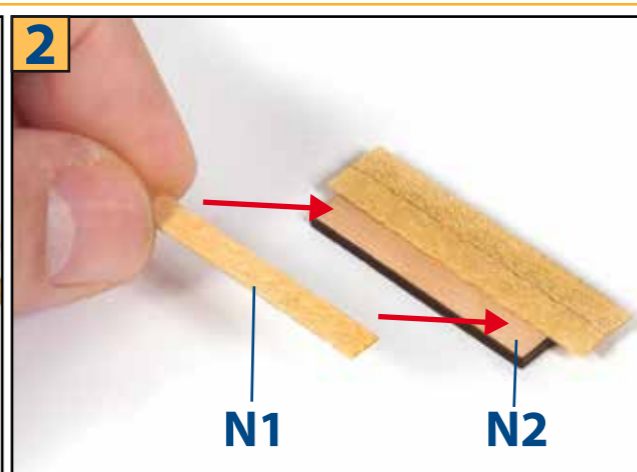
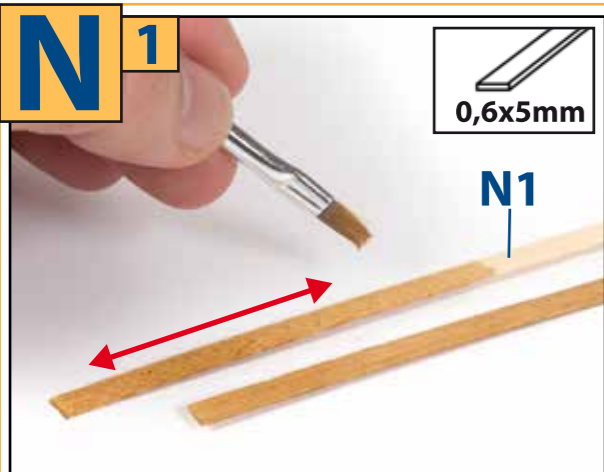

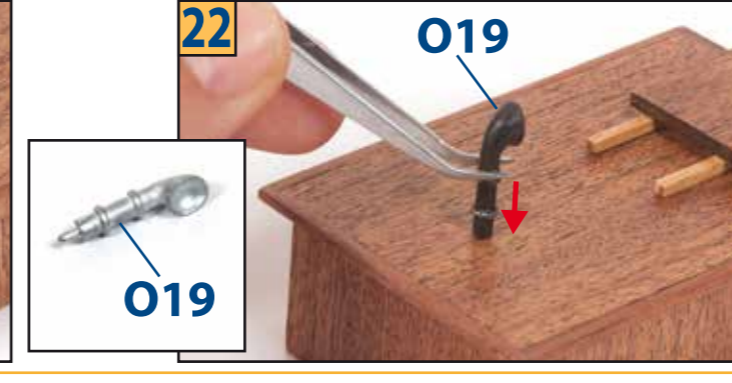
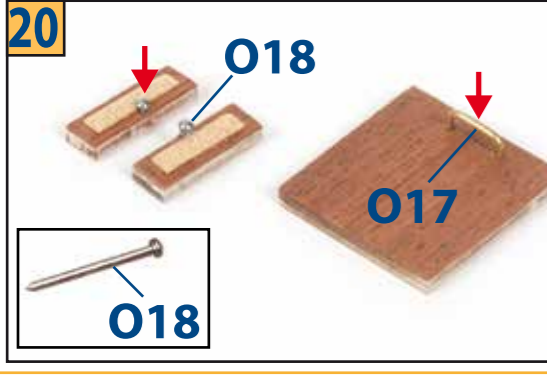
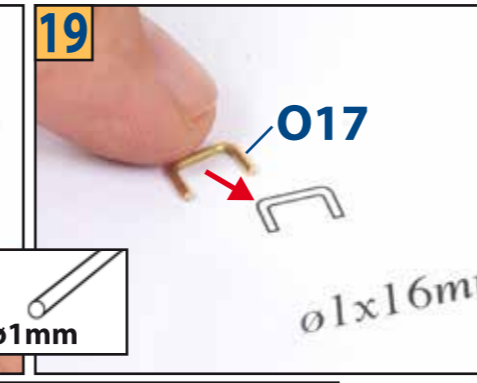
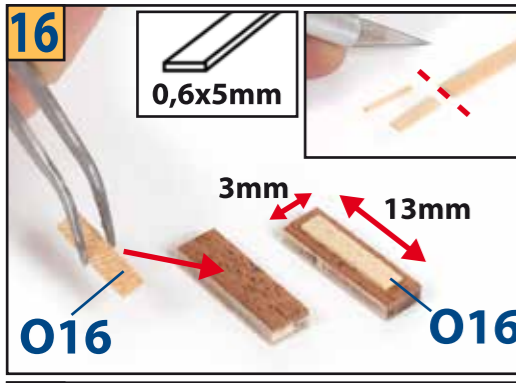
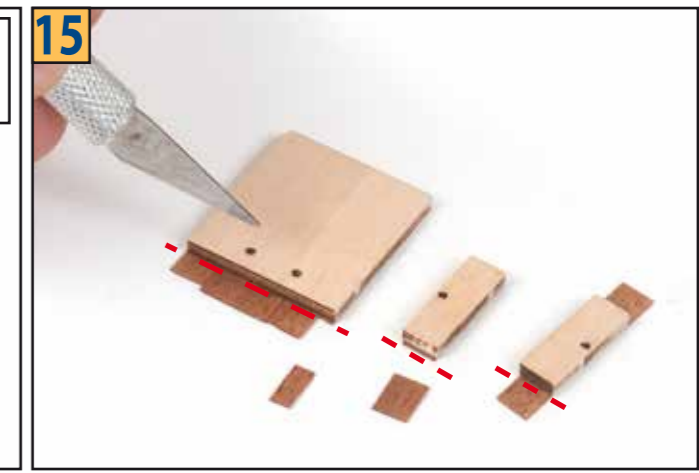
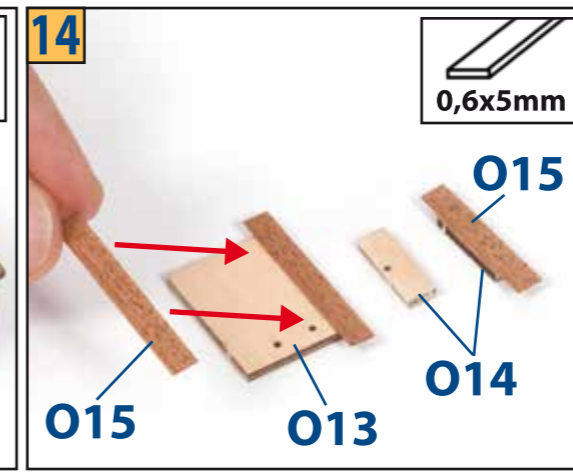
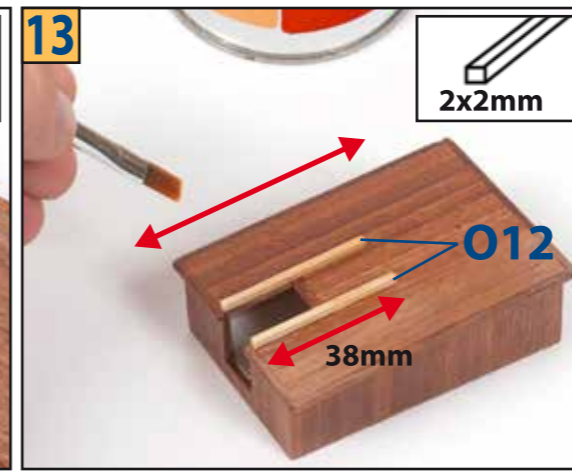
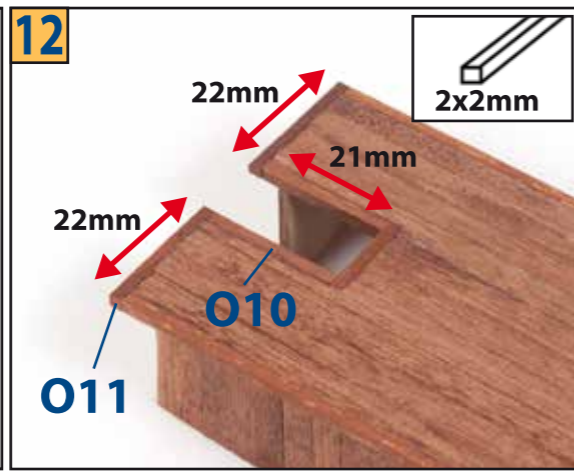
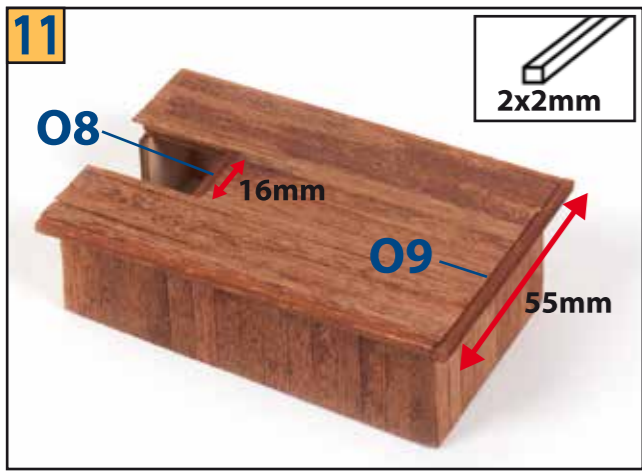
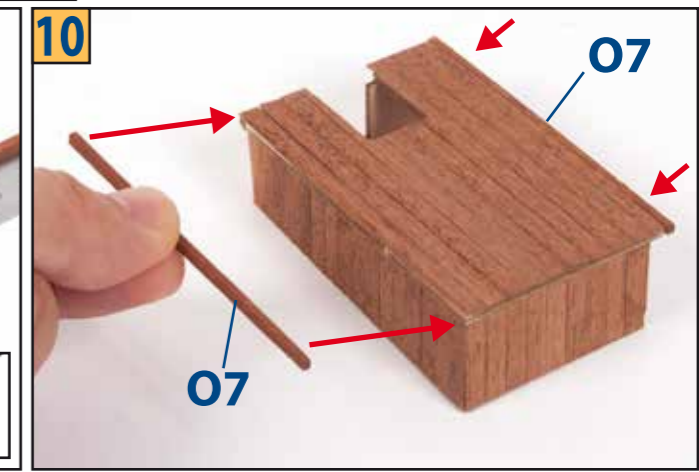
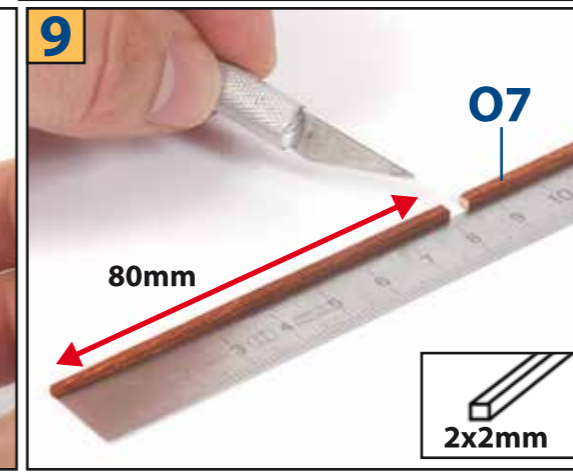
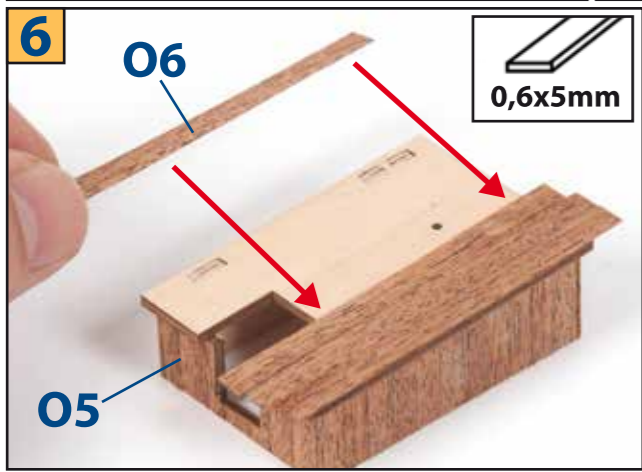
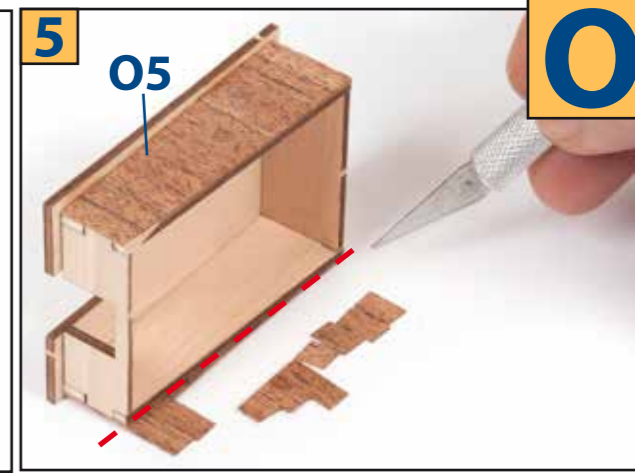
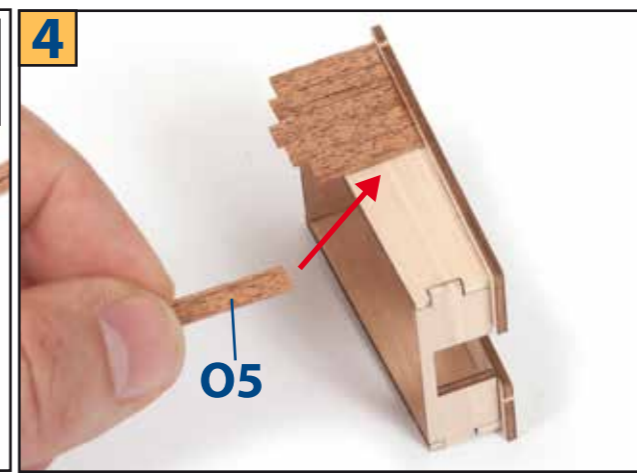
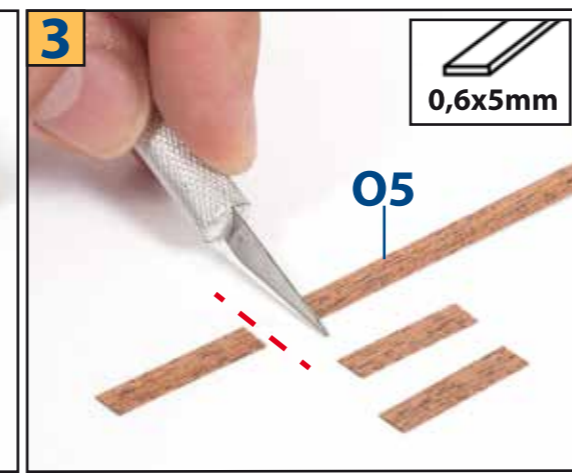
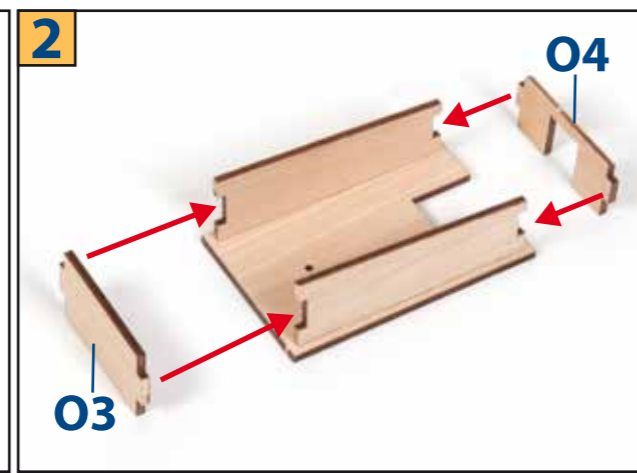
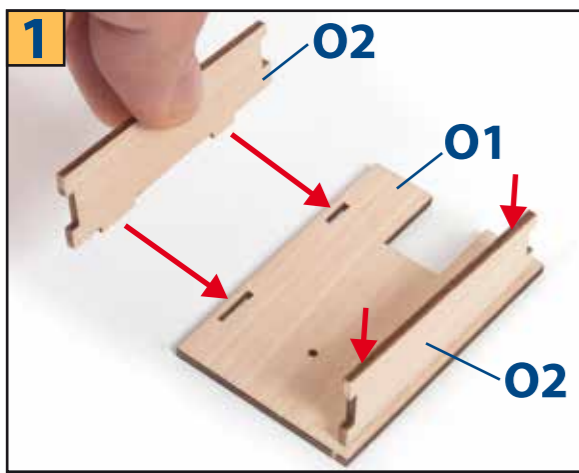

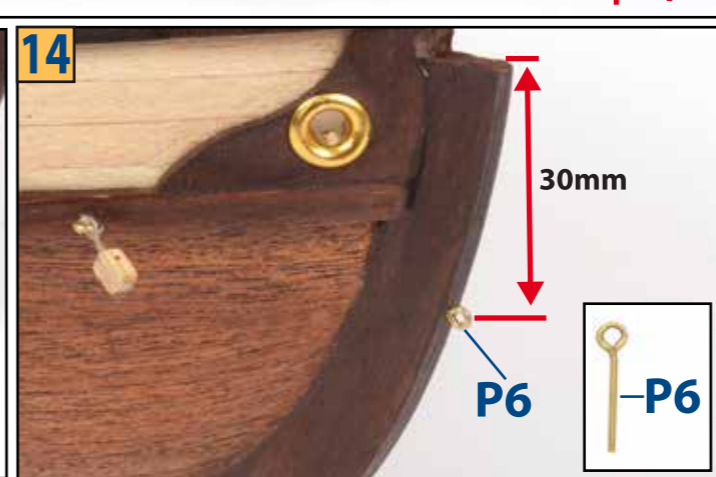
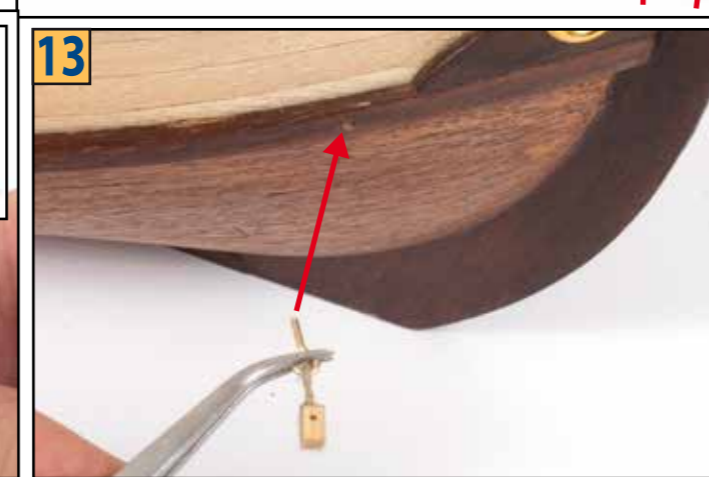
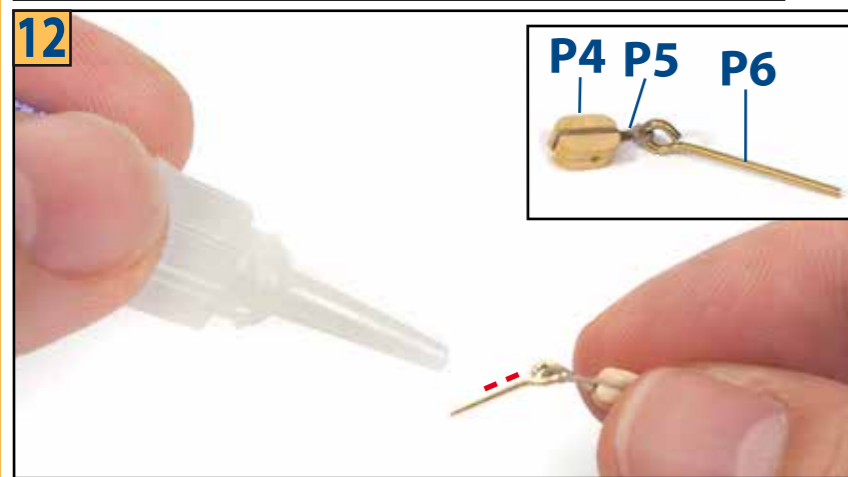
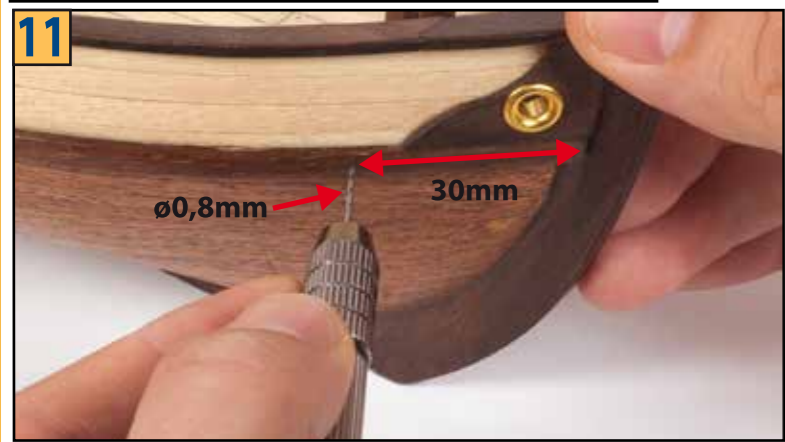
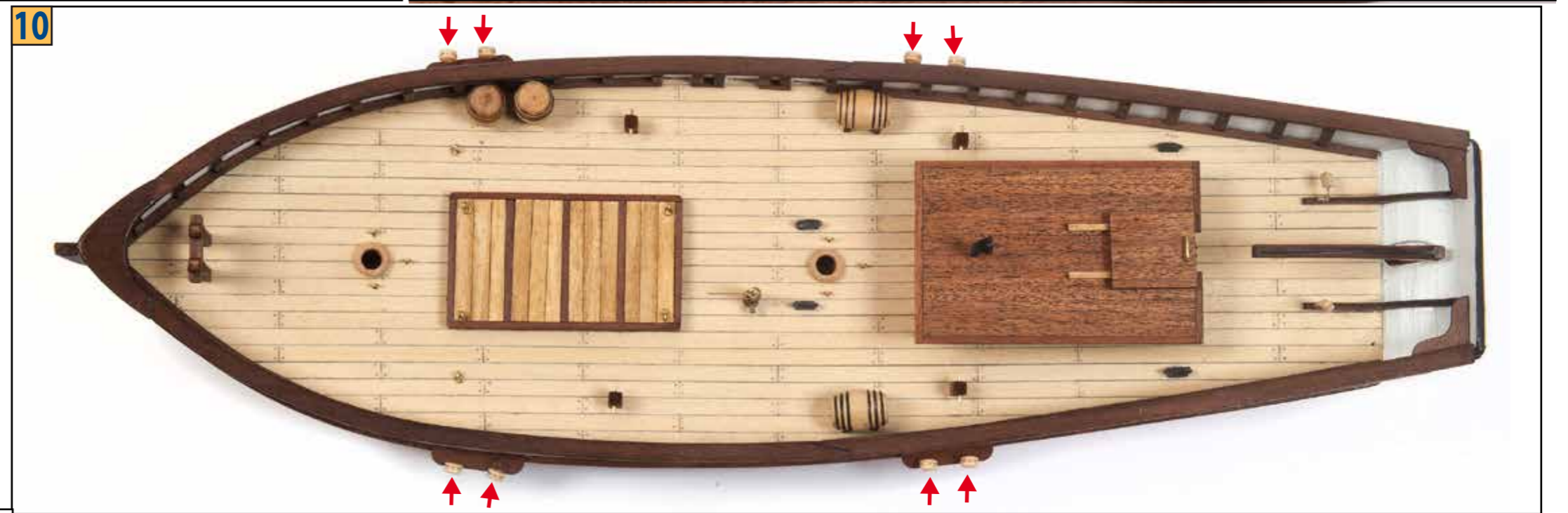
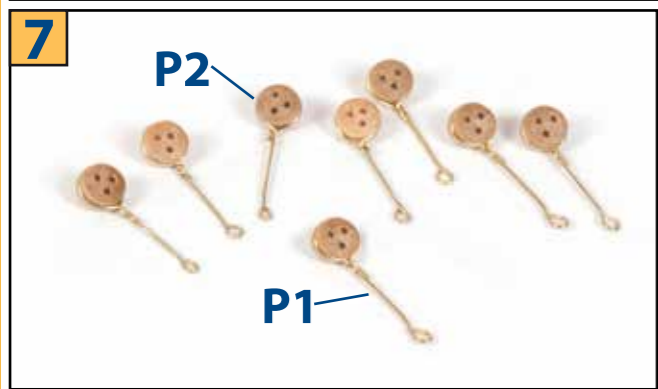
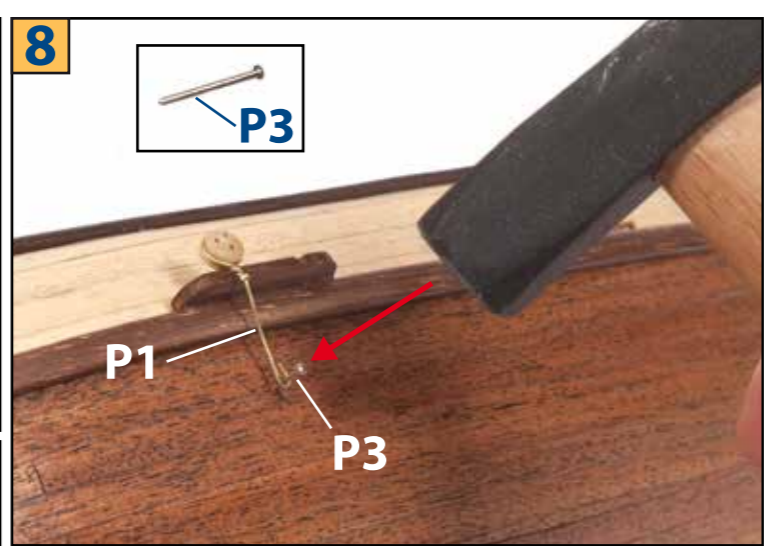
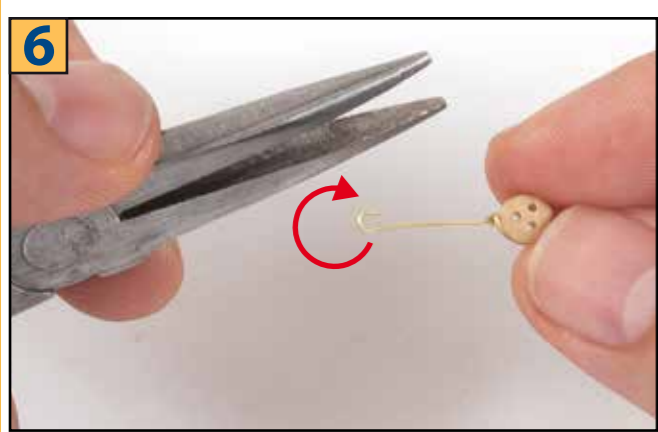
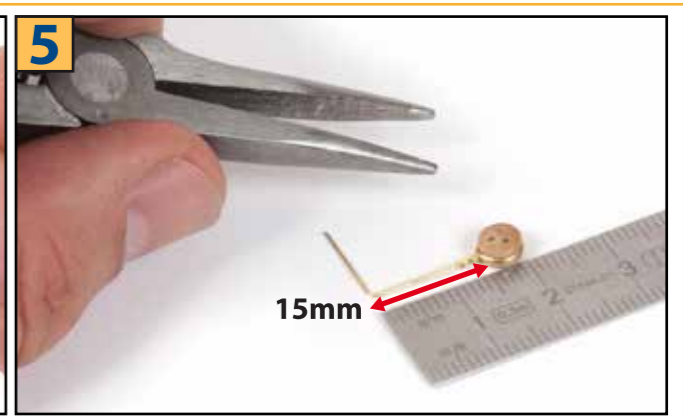
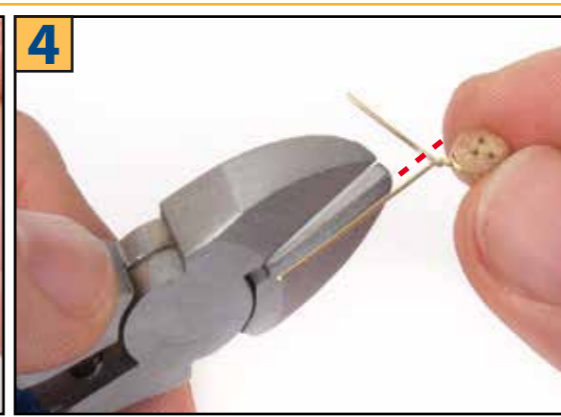
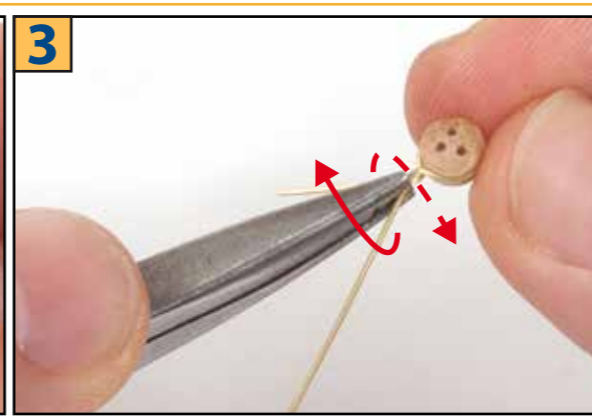
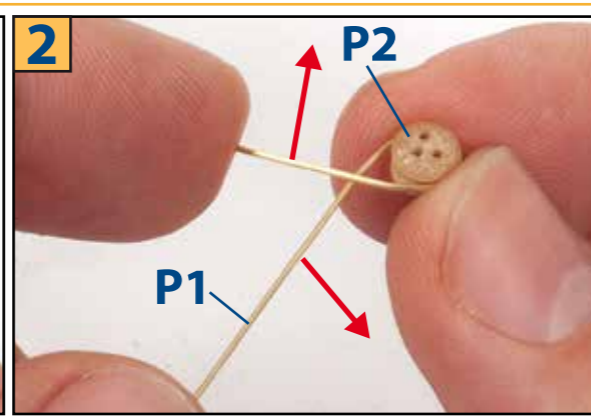
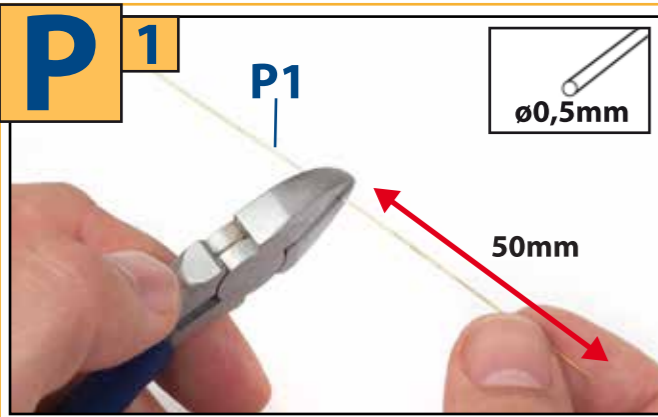

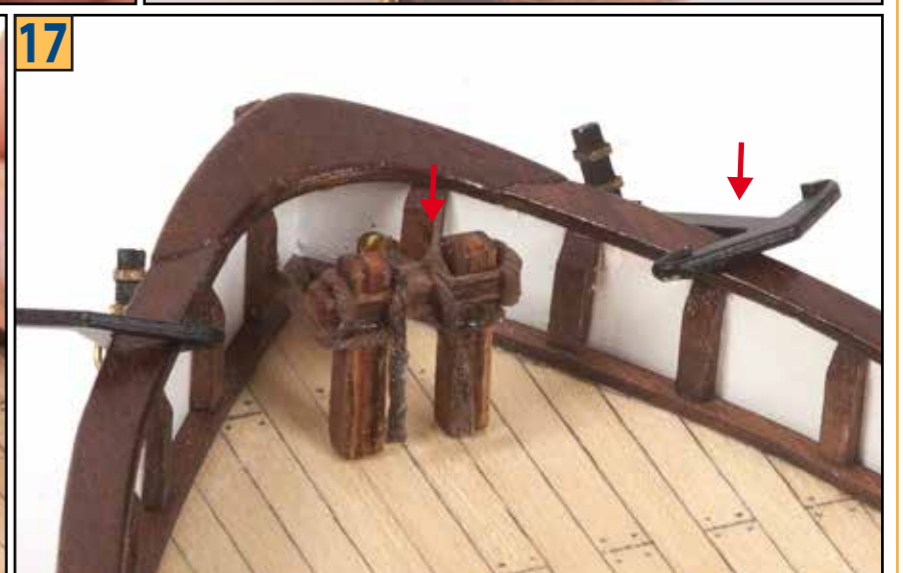
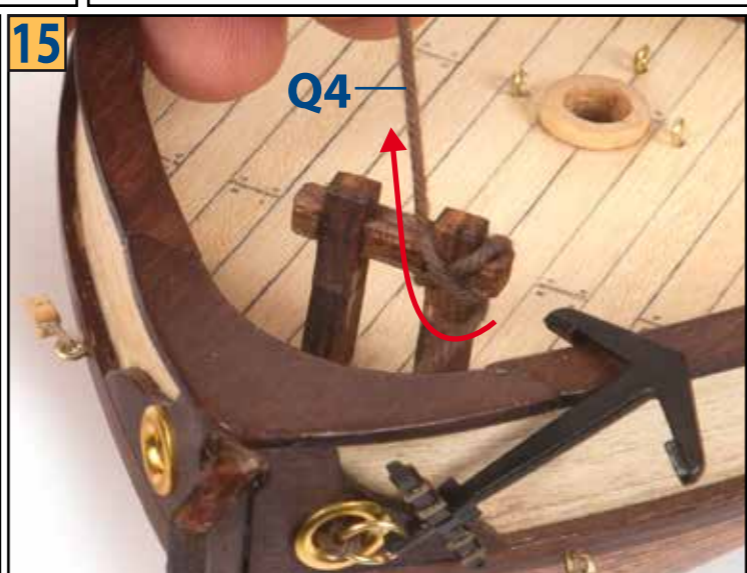
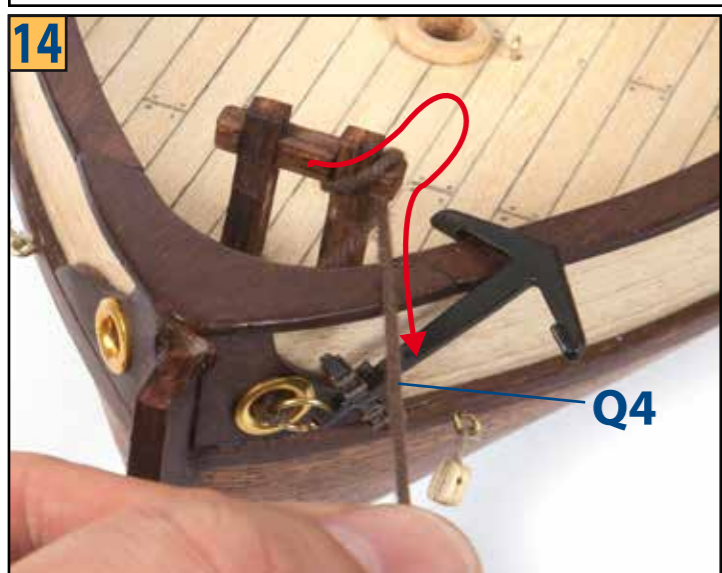
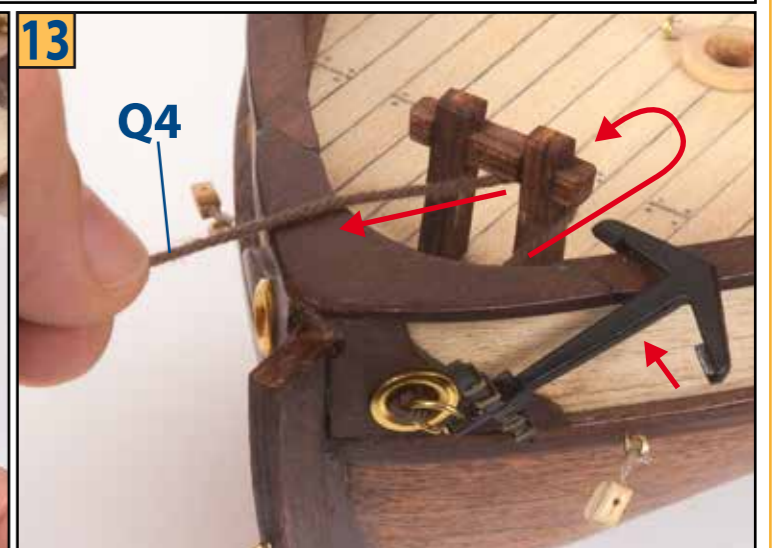
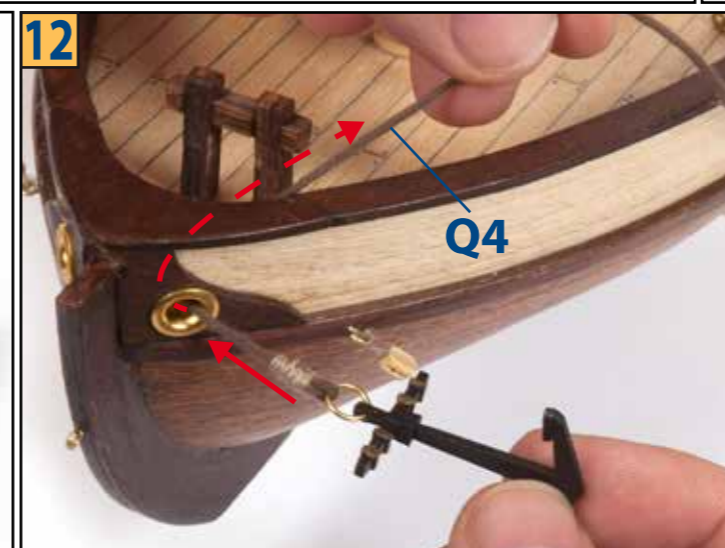
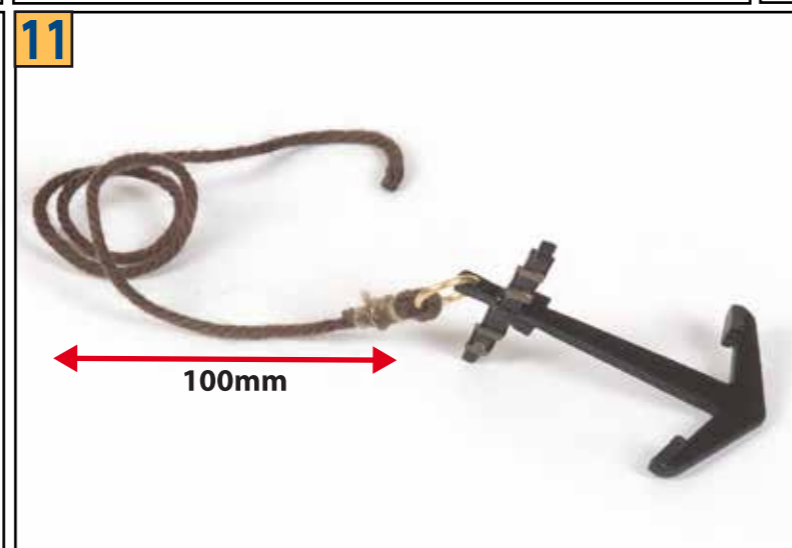
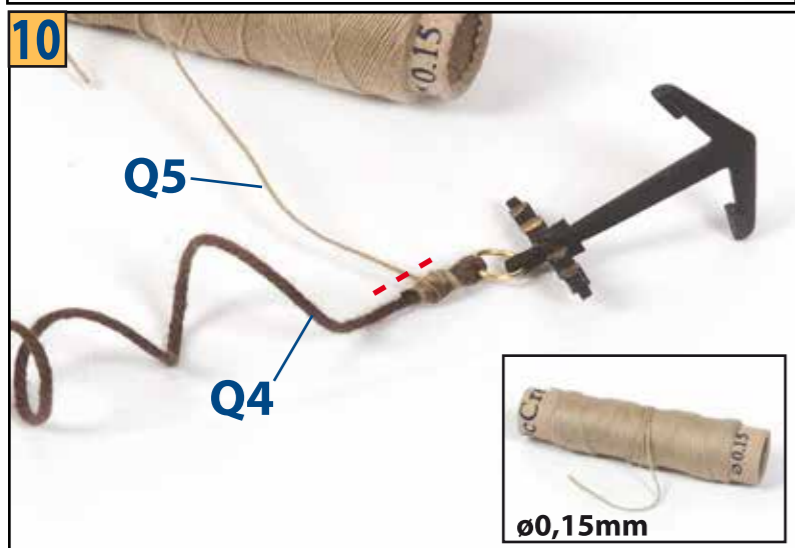
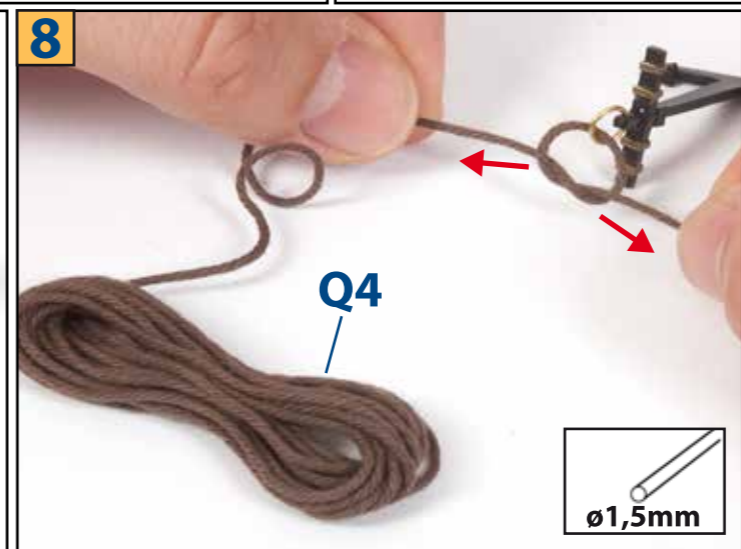
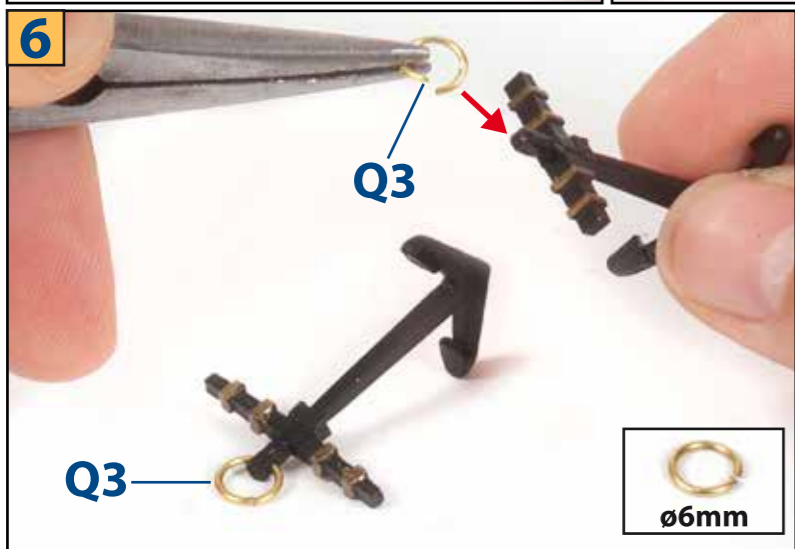
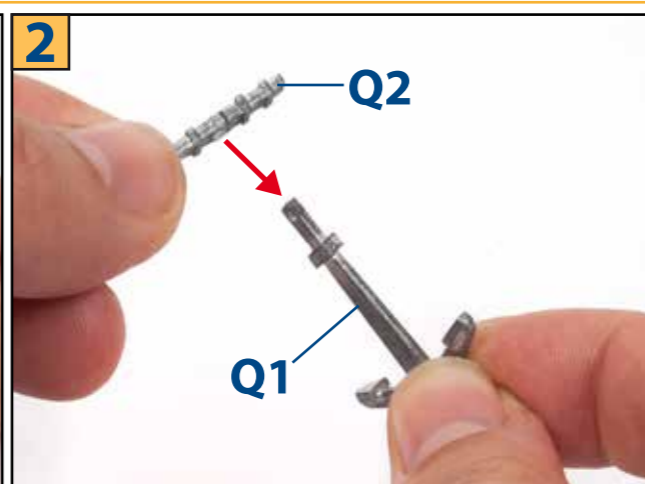
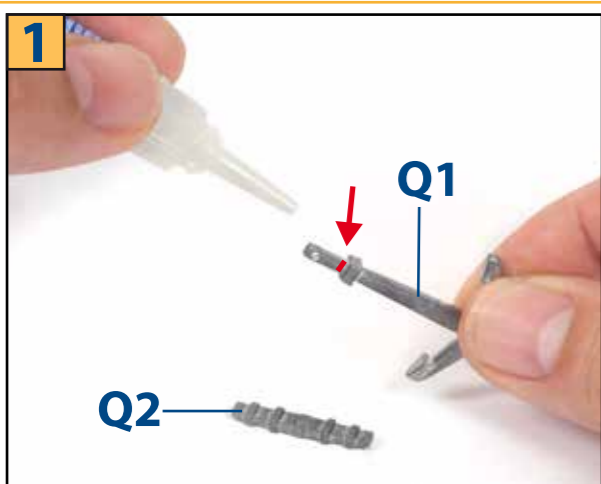

Bauprés / Bousprit / Beaupré / Bugsprit / Bompresso

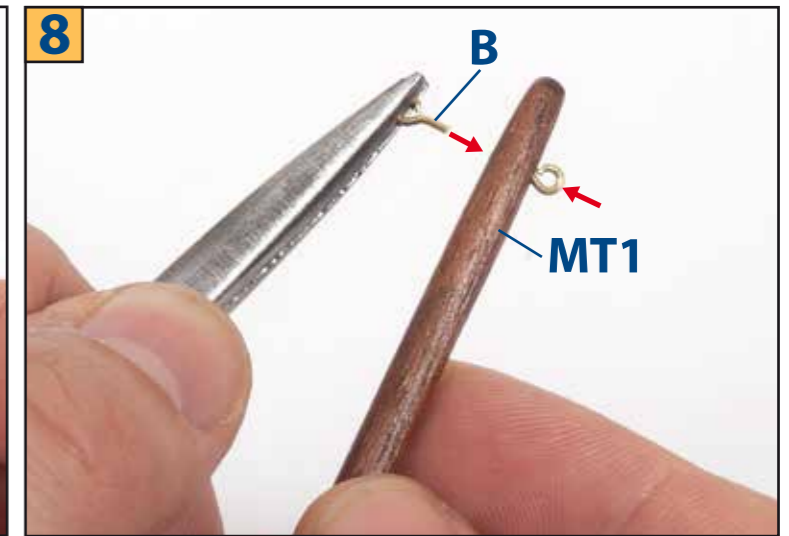
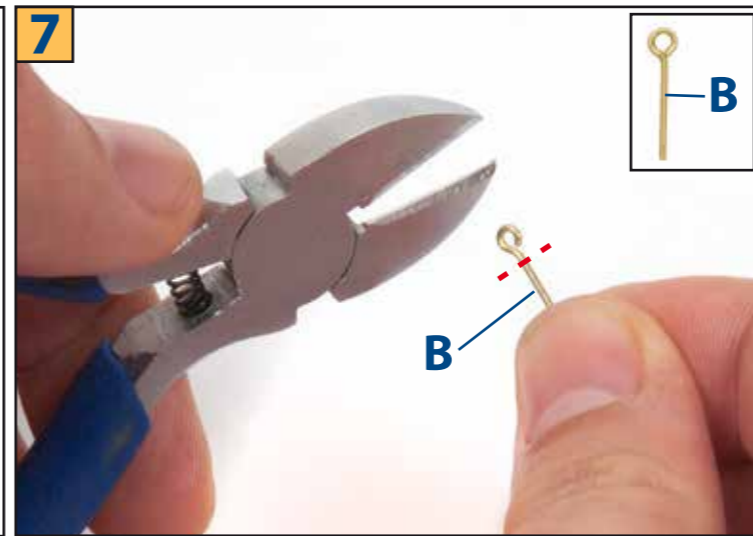
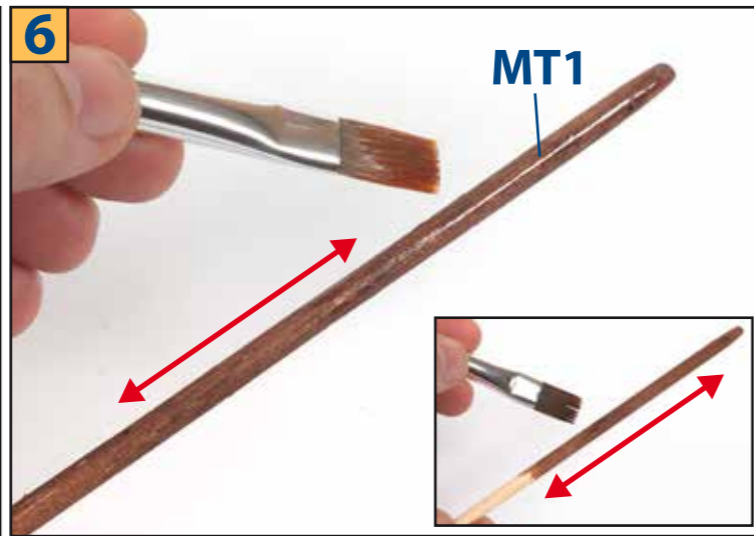
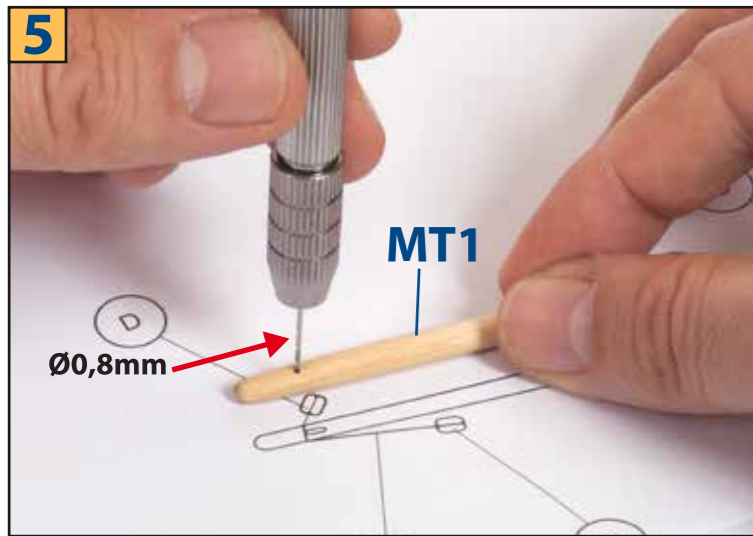
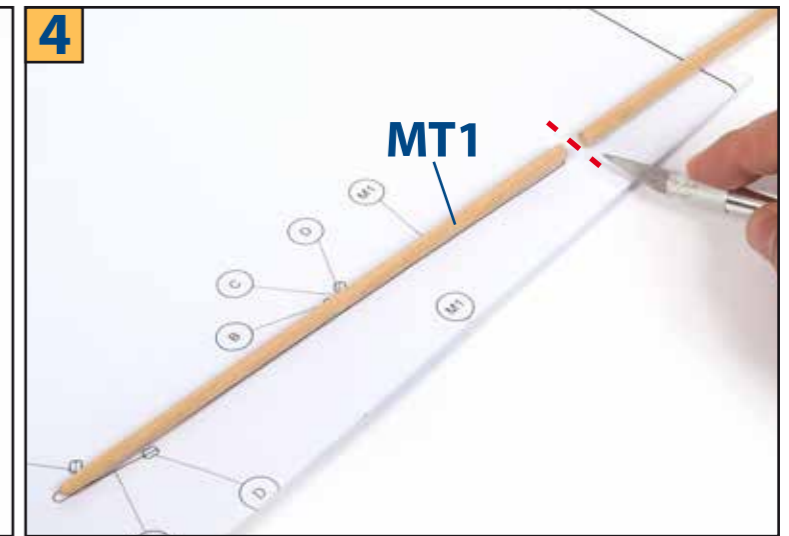
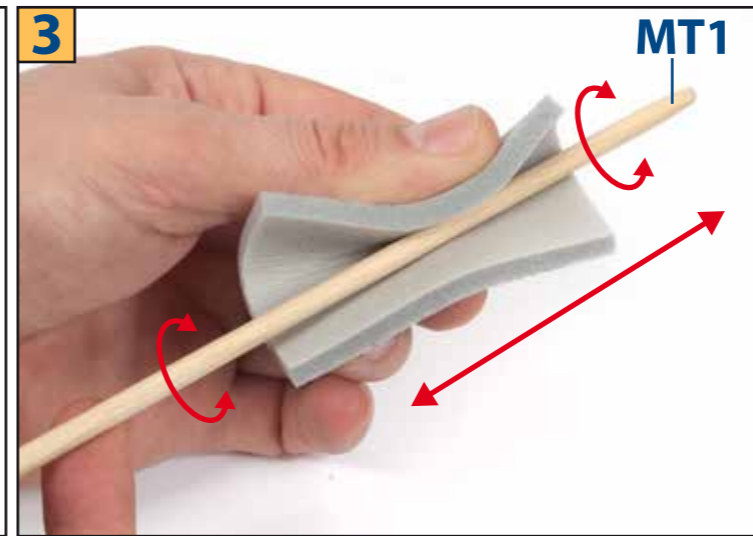
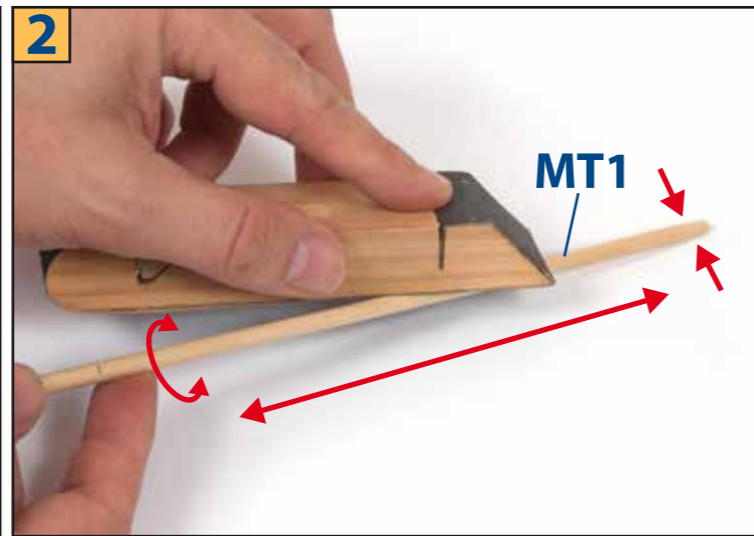
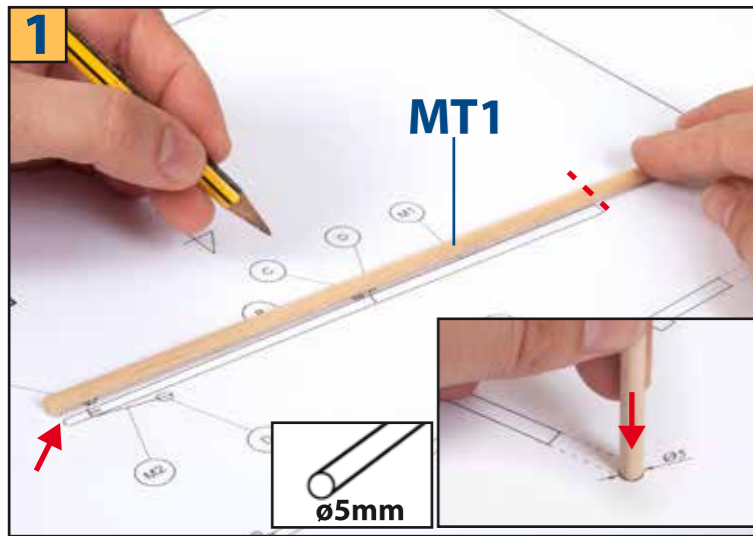

Consultar los planos de mástiles
 Consult the masts drawings
 Consulte os desenhos dos mastros
 Consulter les dessins des mâts
 Konsultieren Sie die Mastenzeichnungen
 Обратитесь к рисункам мачты
 Consultare i disegni degli alberi

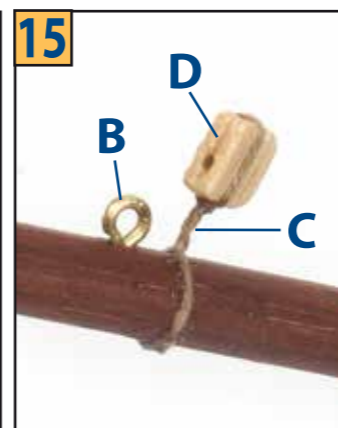
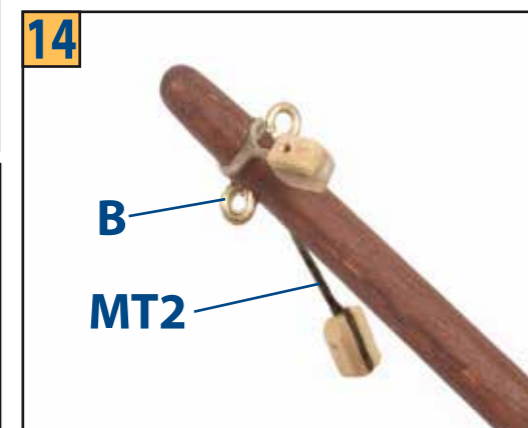
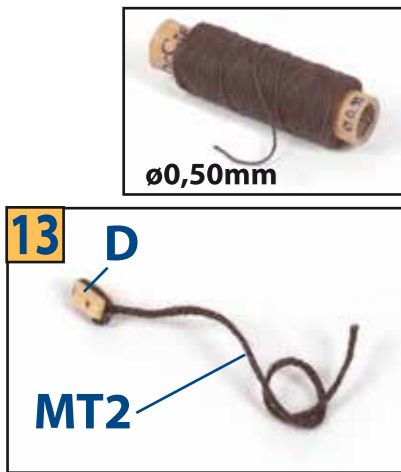
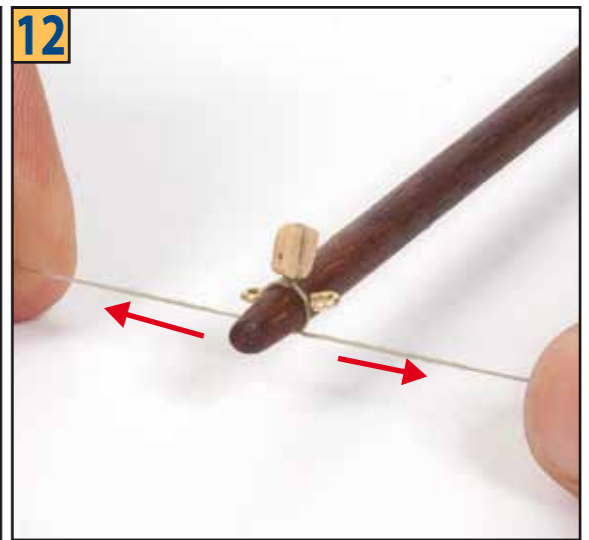
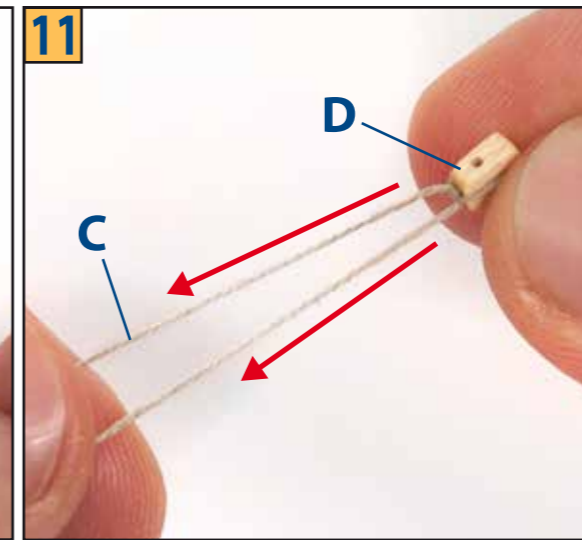
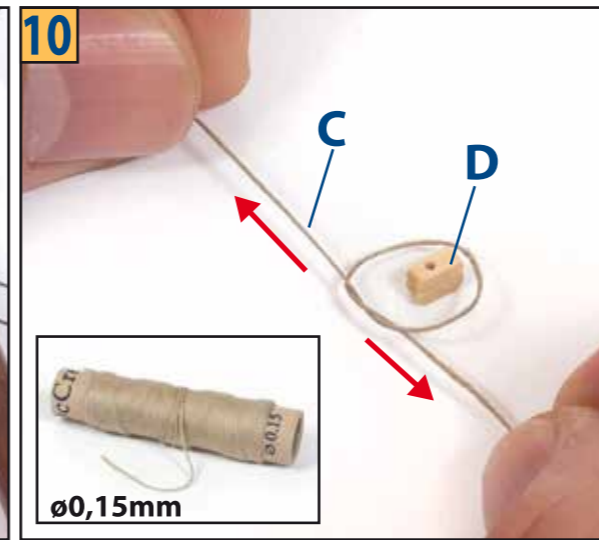
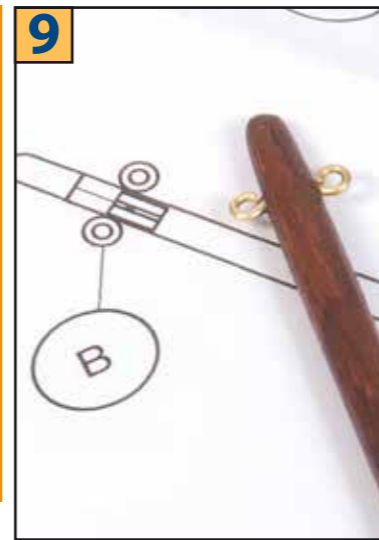

Palo trinquete / Fore mast / Mât de masaine / Fockmast / Albero trinchetto

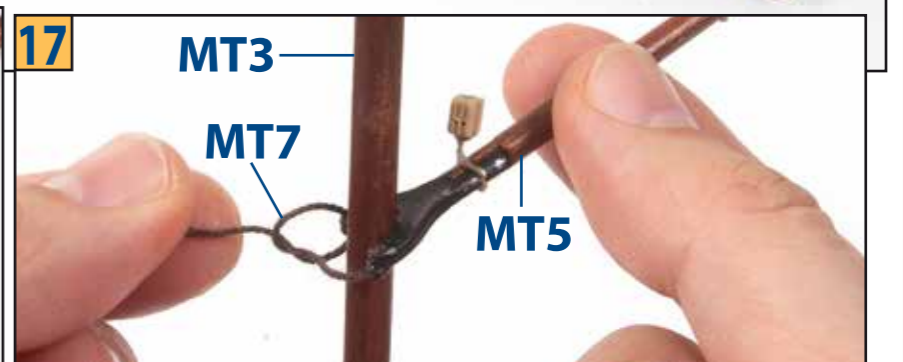
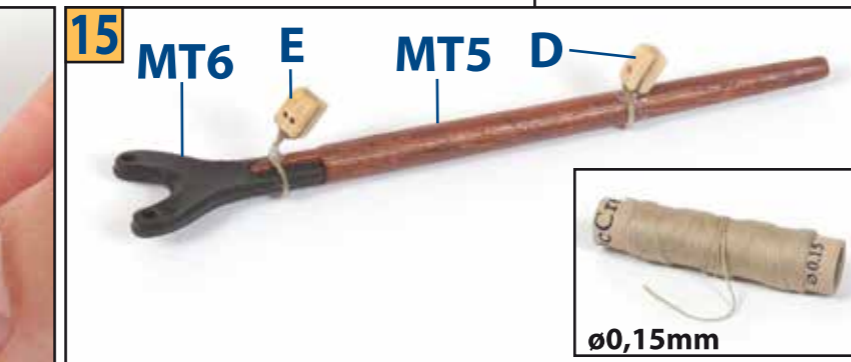
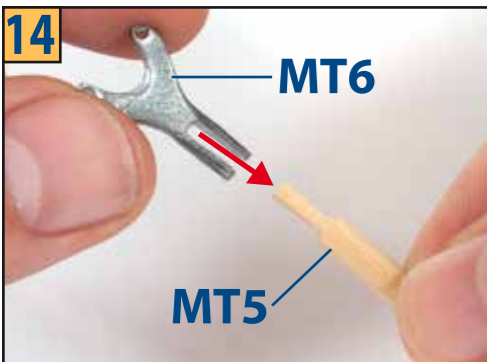
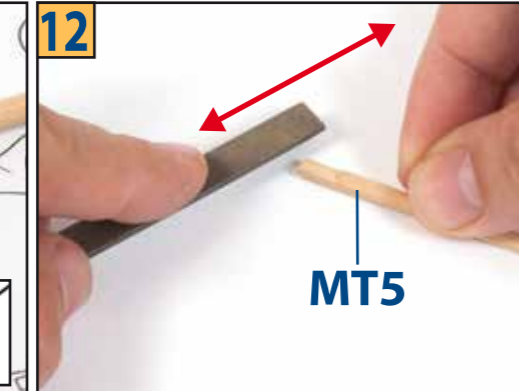
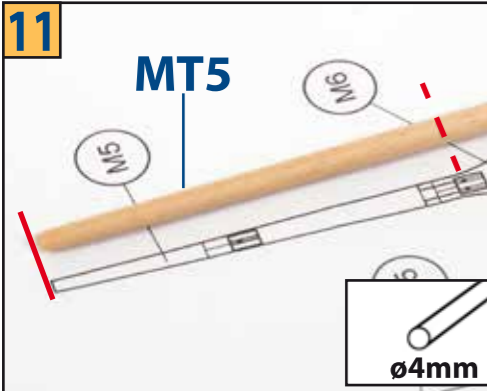
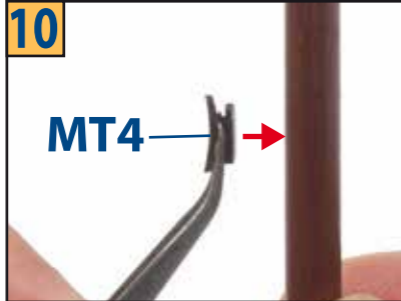
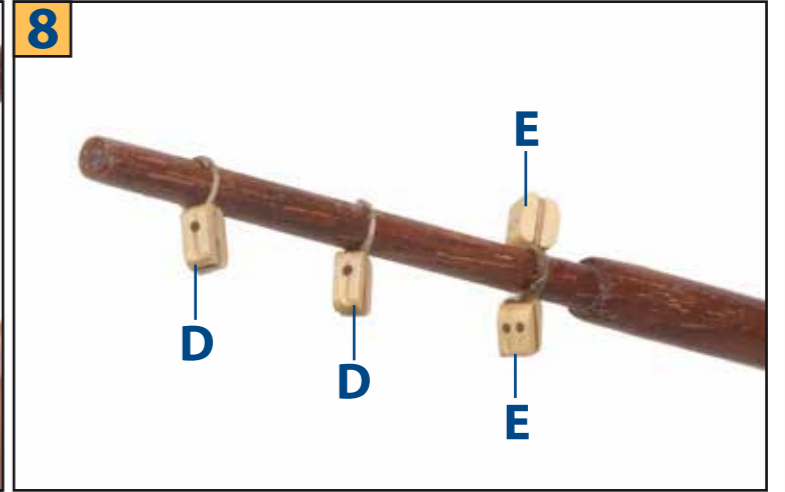
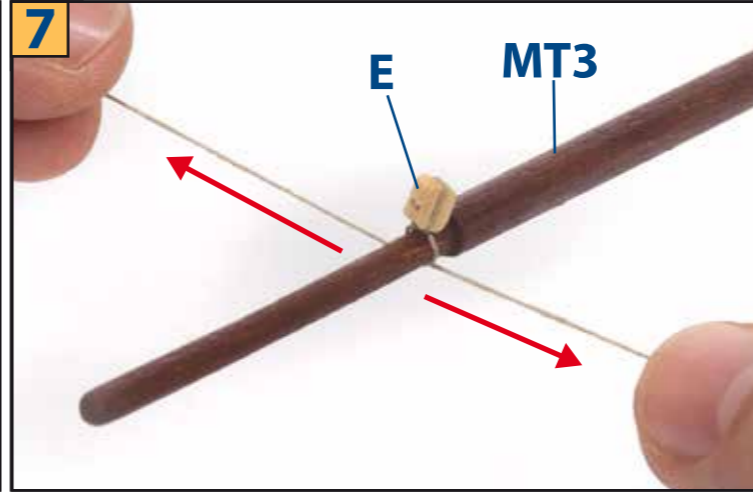
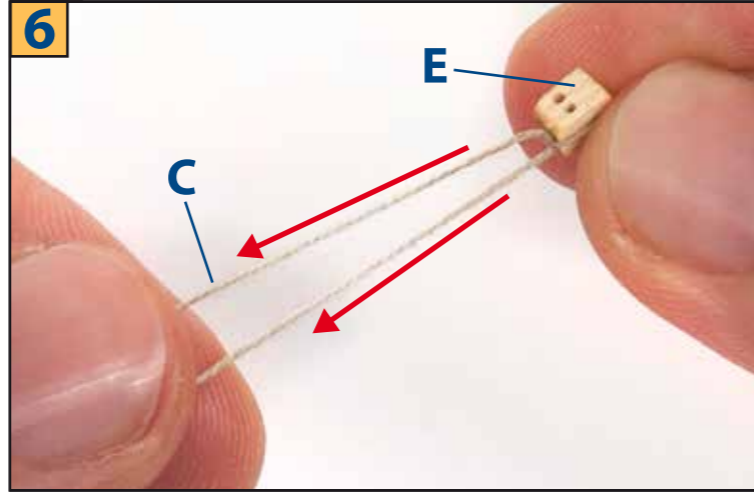
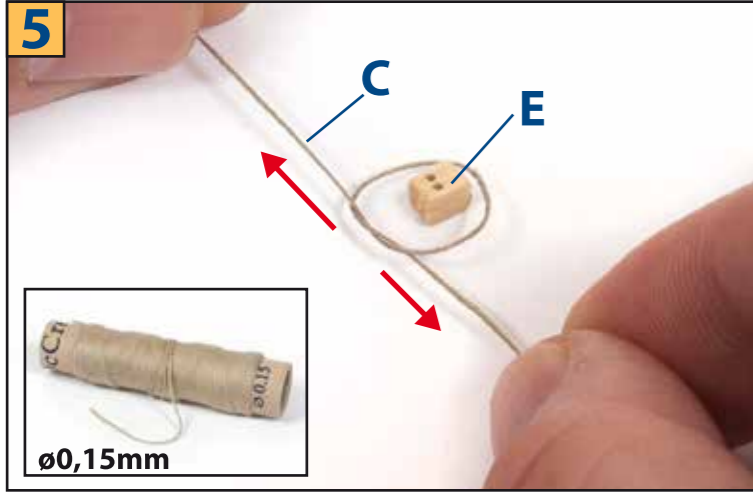
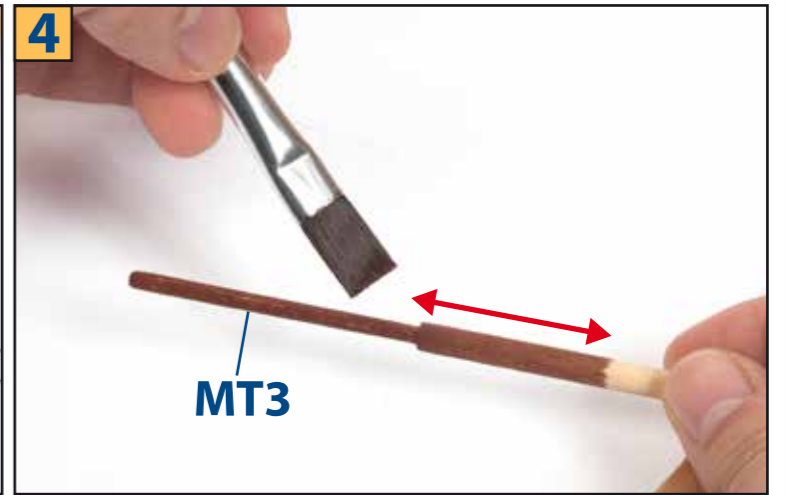
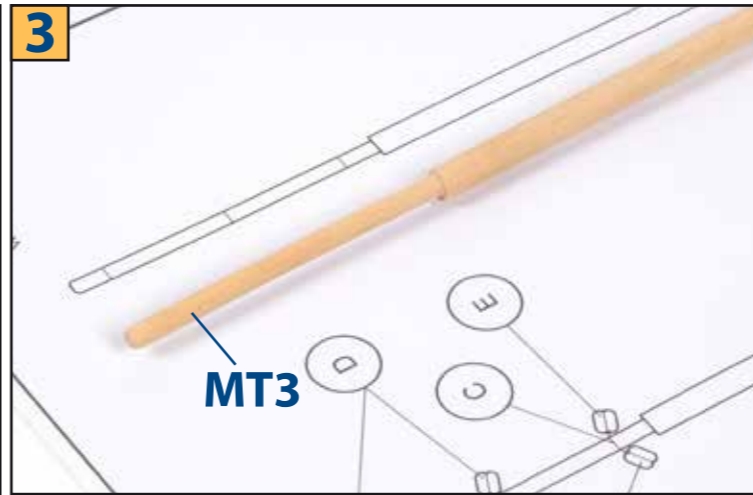
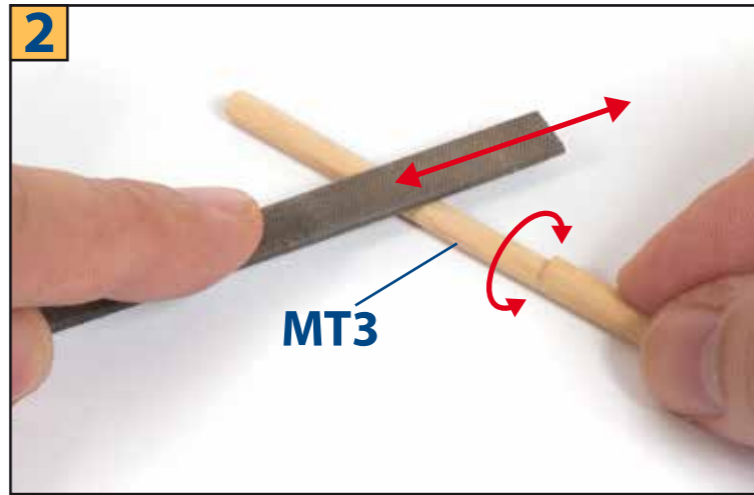
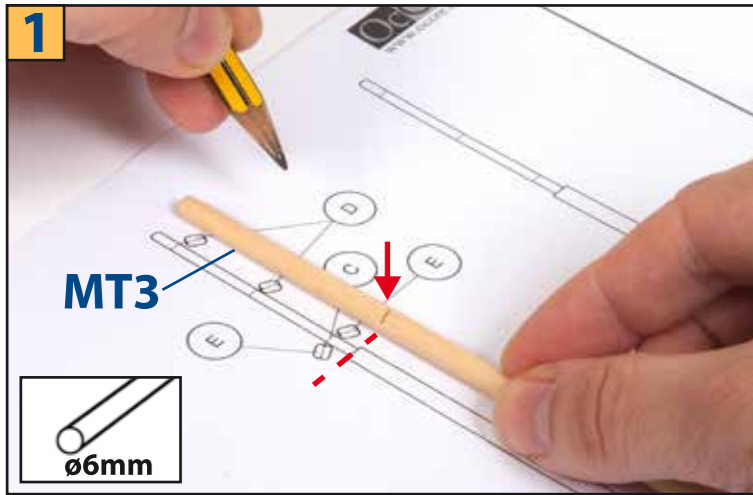

Palo mayor / Main mast / Grand mât / Hauptmast / Albero principale

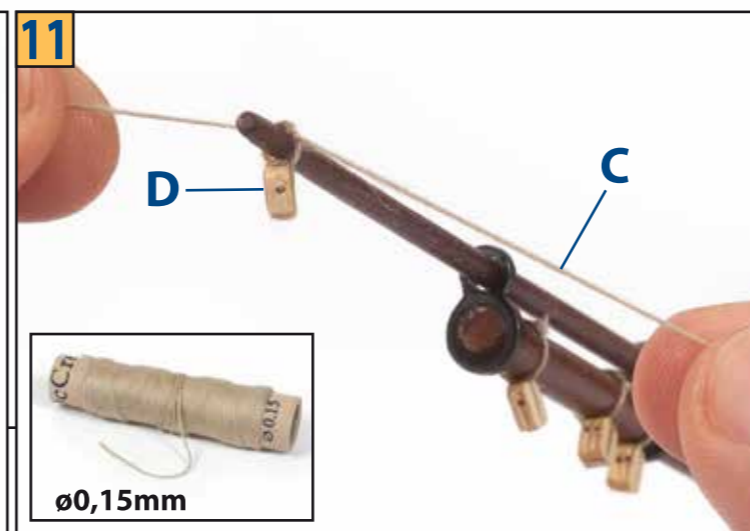
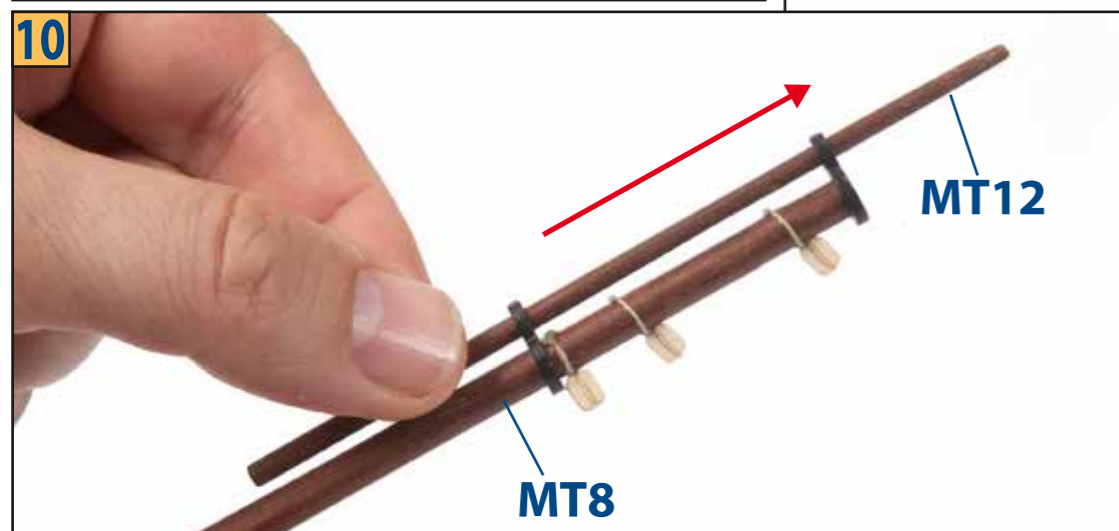
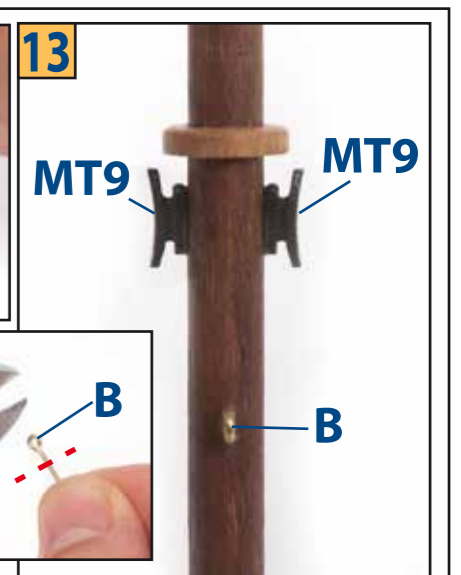
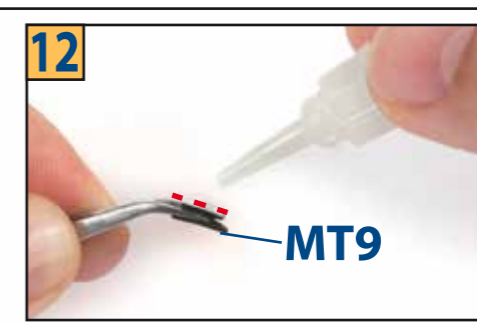
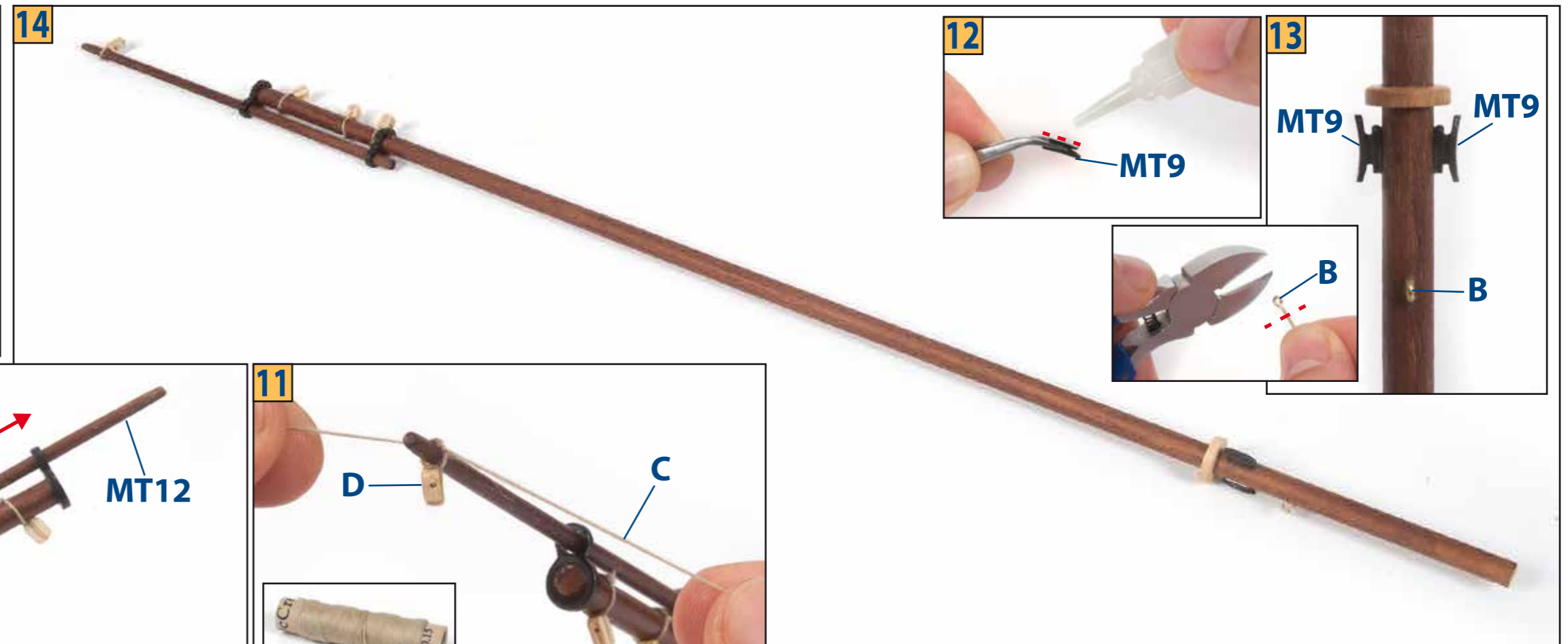
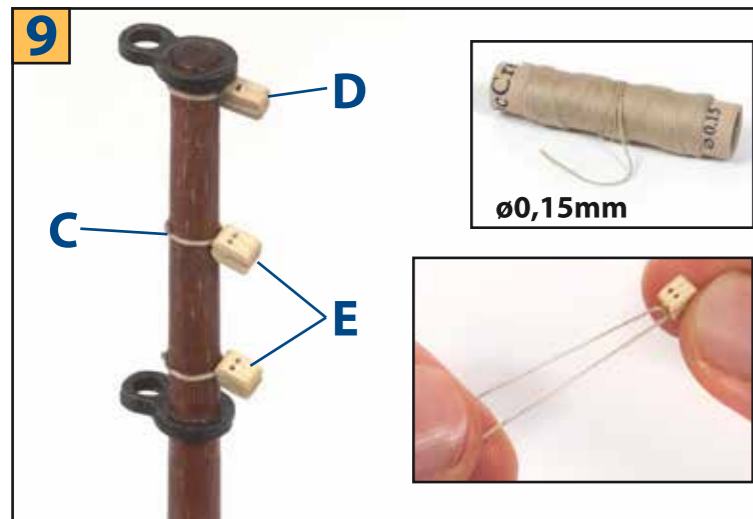
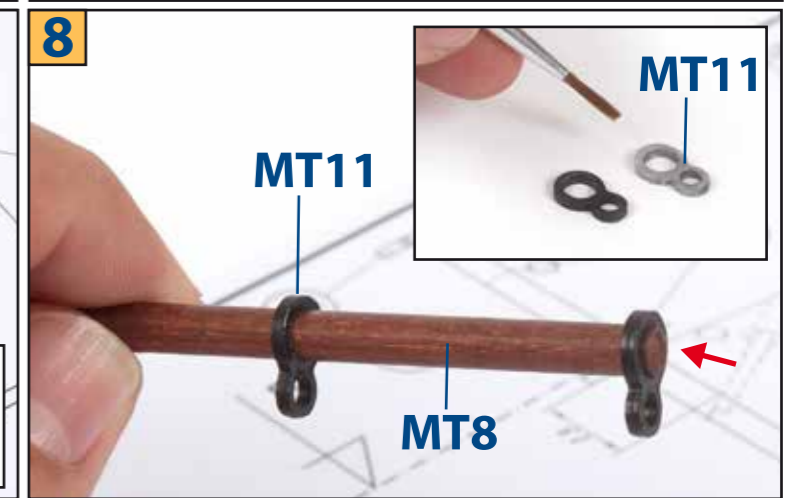
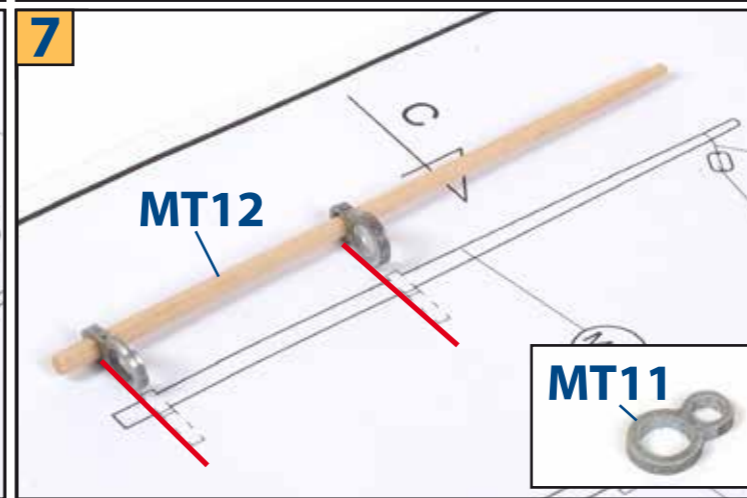
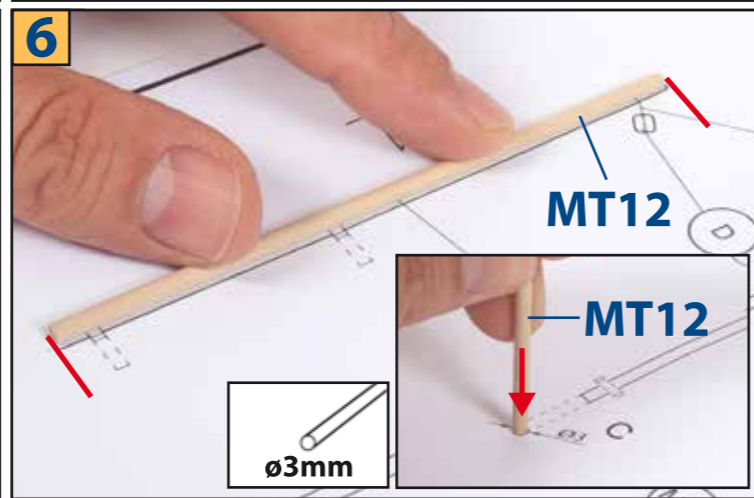
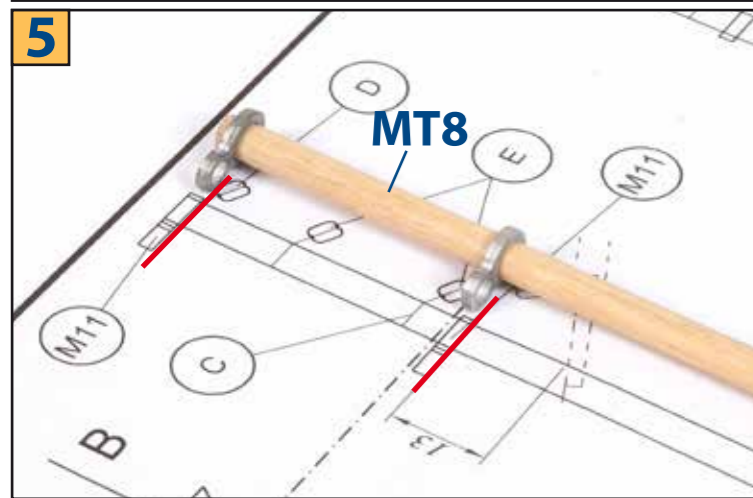
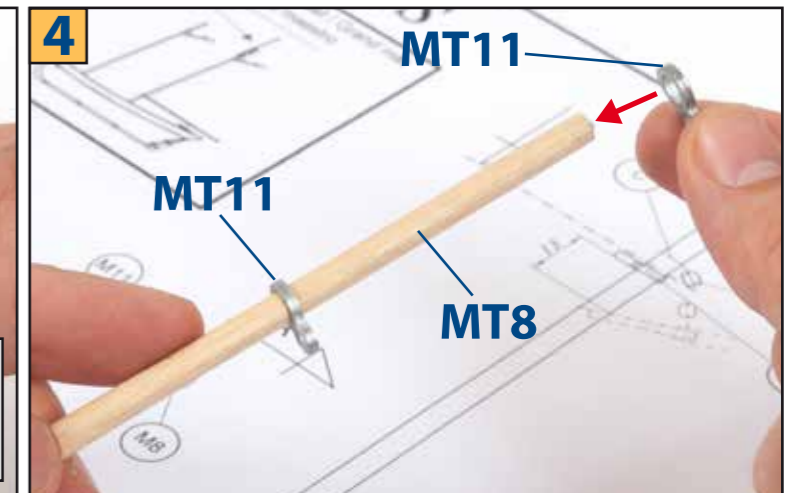
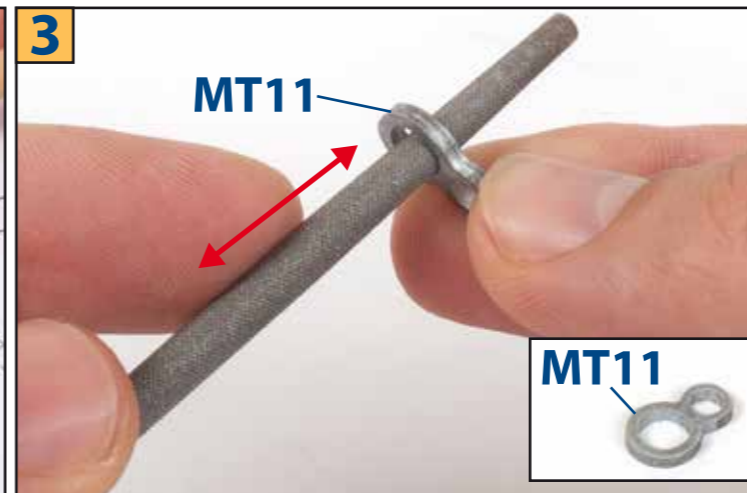
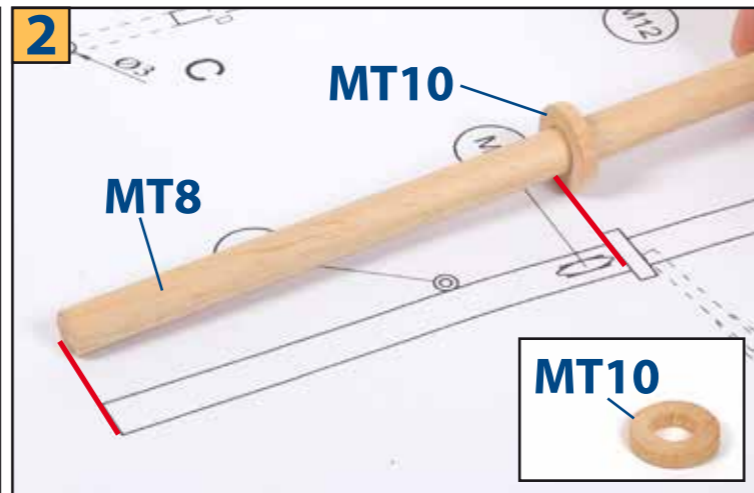
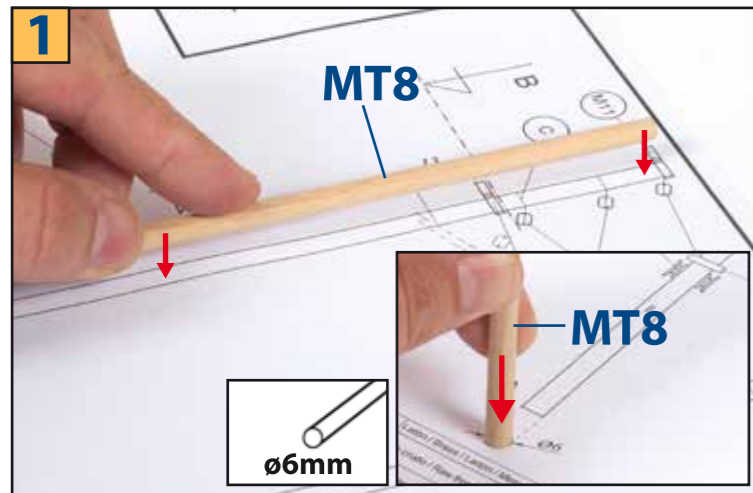

Palo mayor / Main mast / Grand mât / Hauptmast / Albero principale

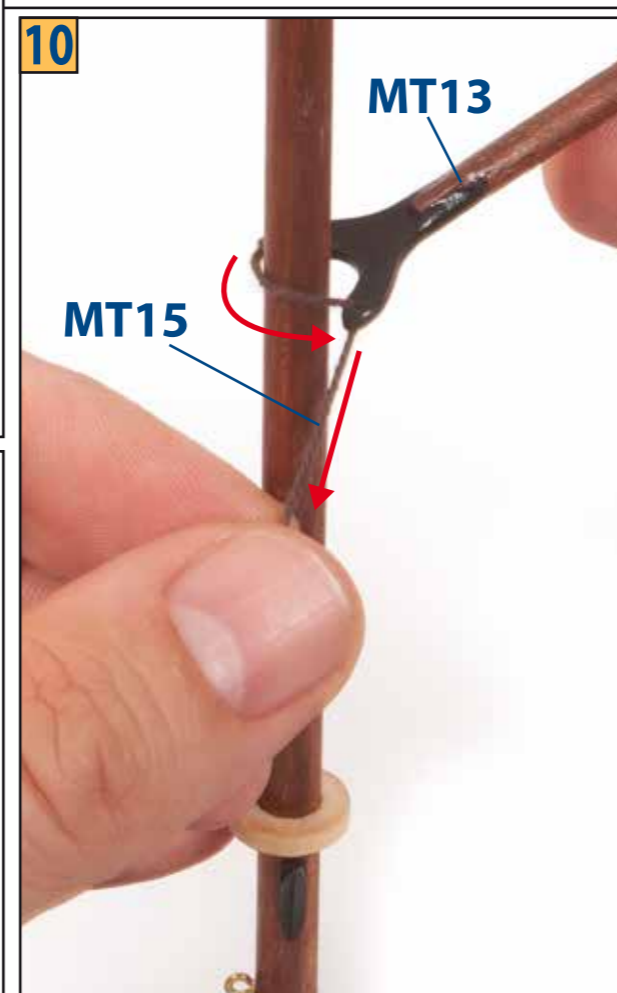
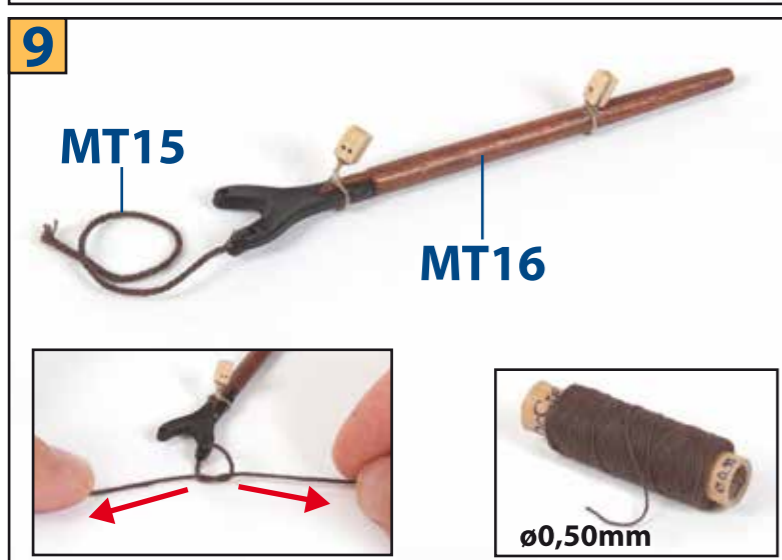
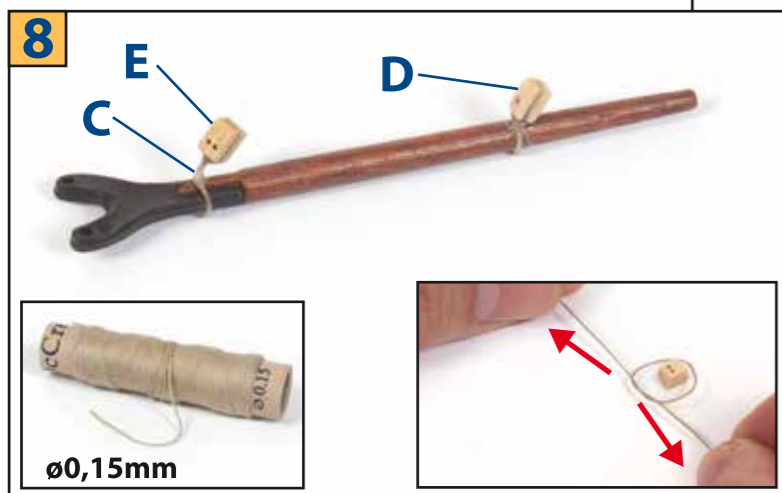
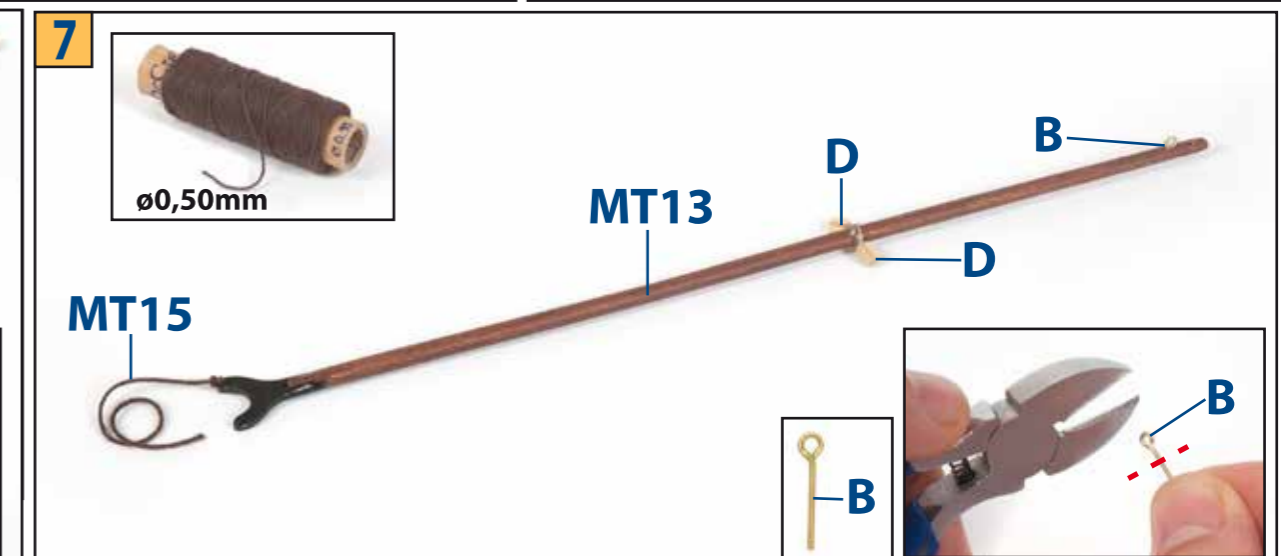
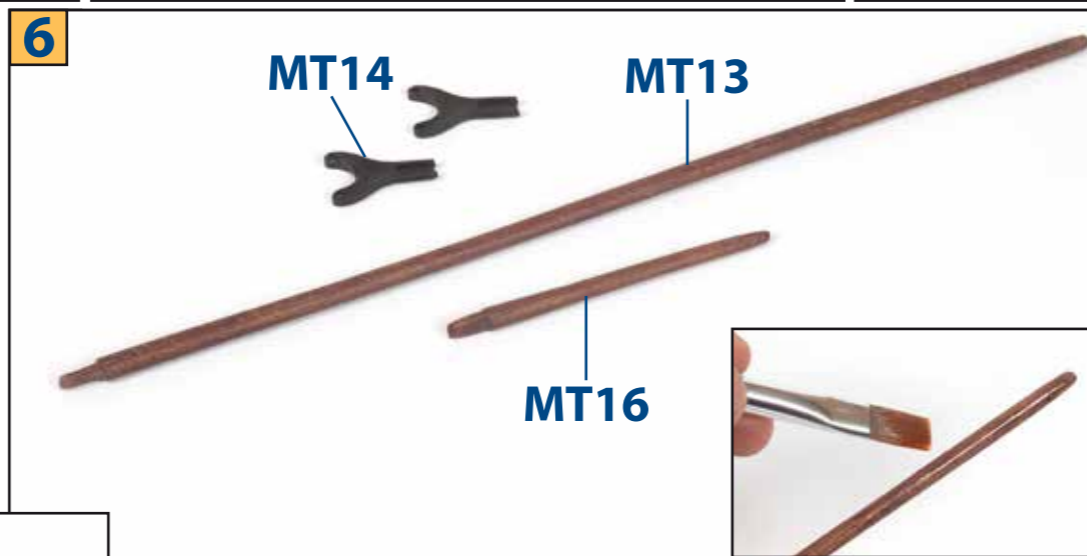
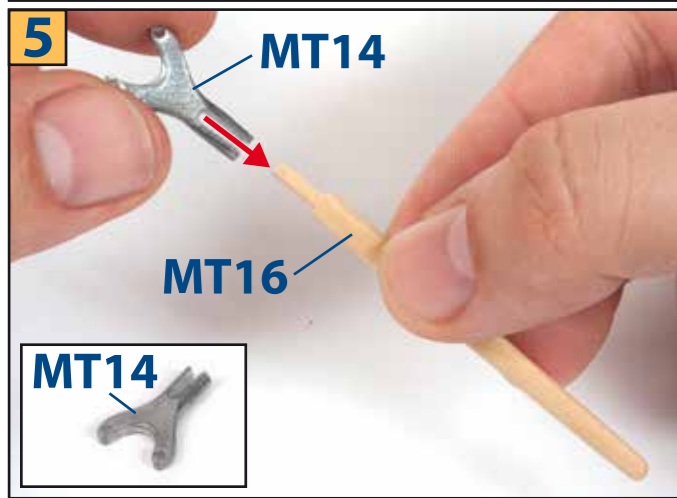
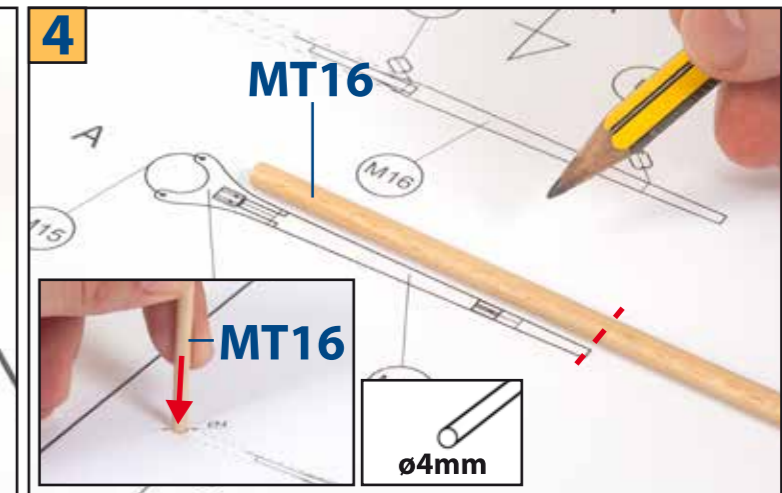
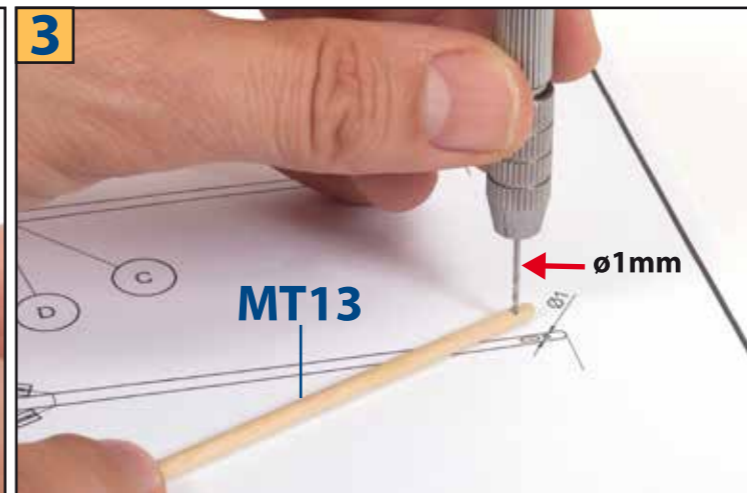
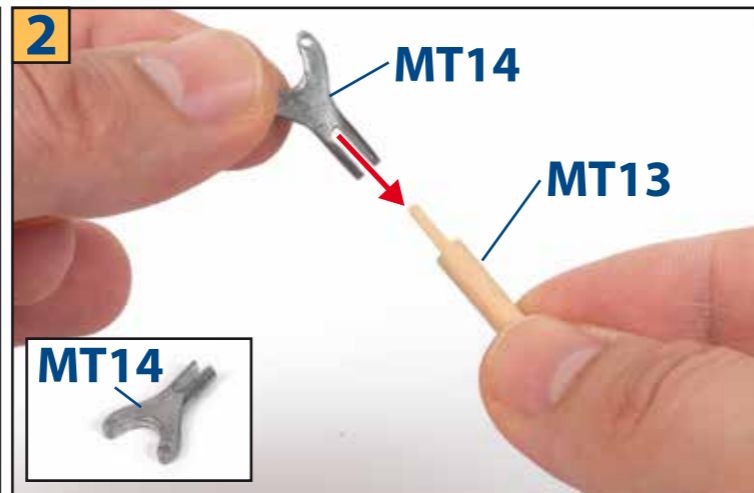
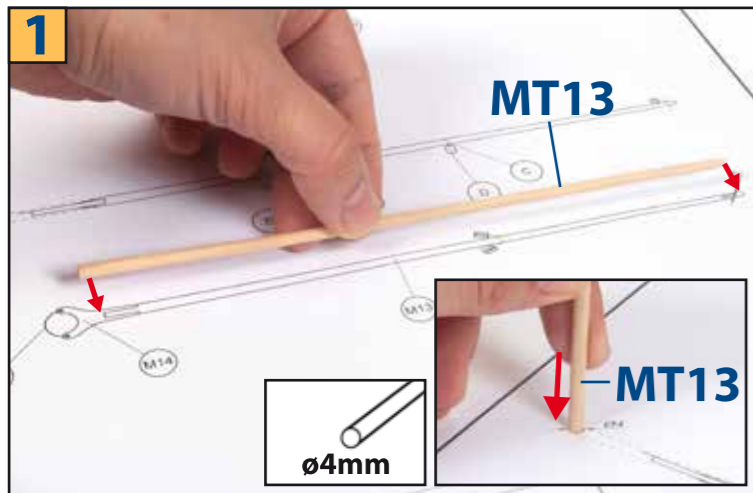

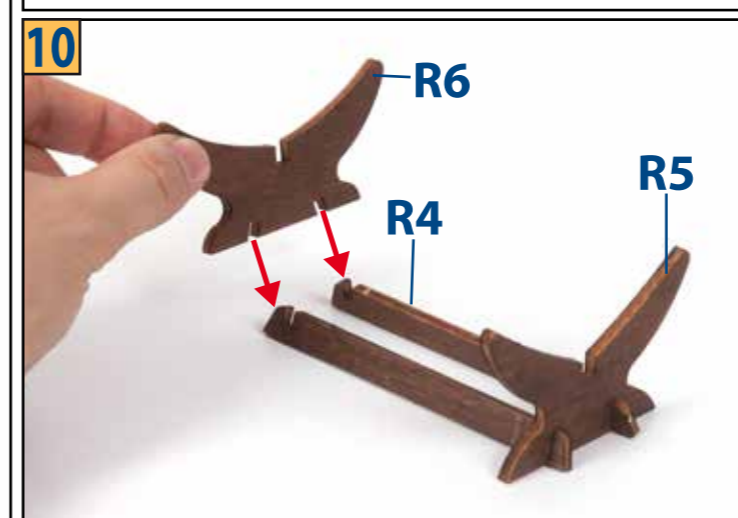
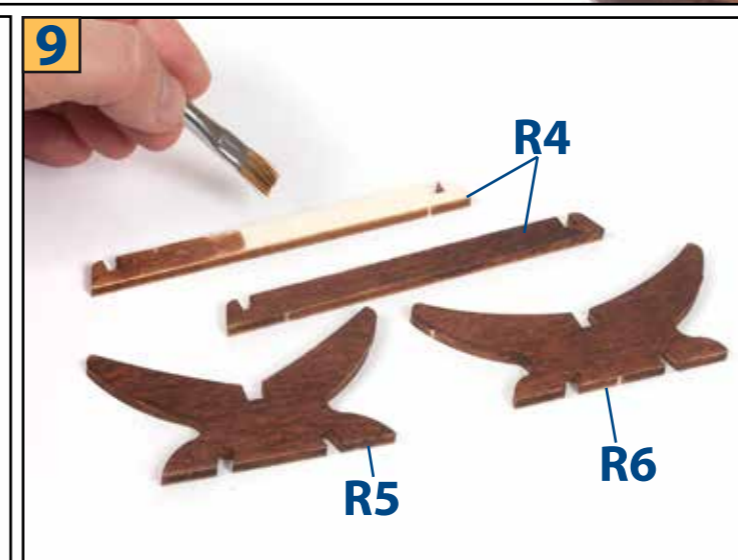
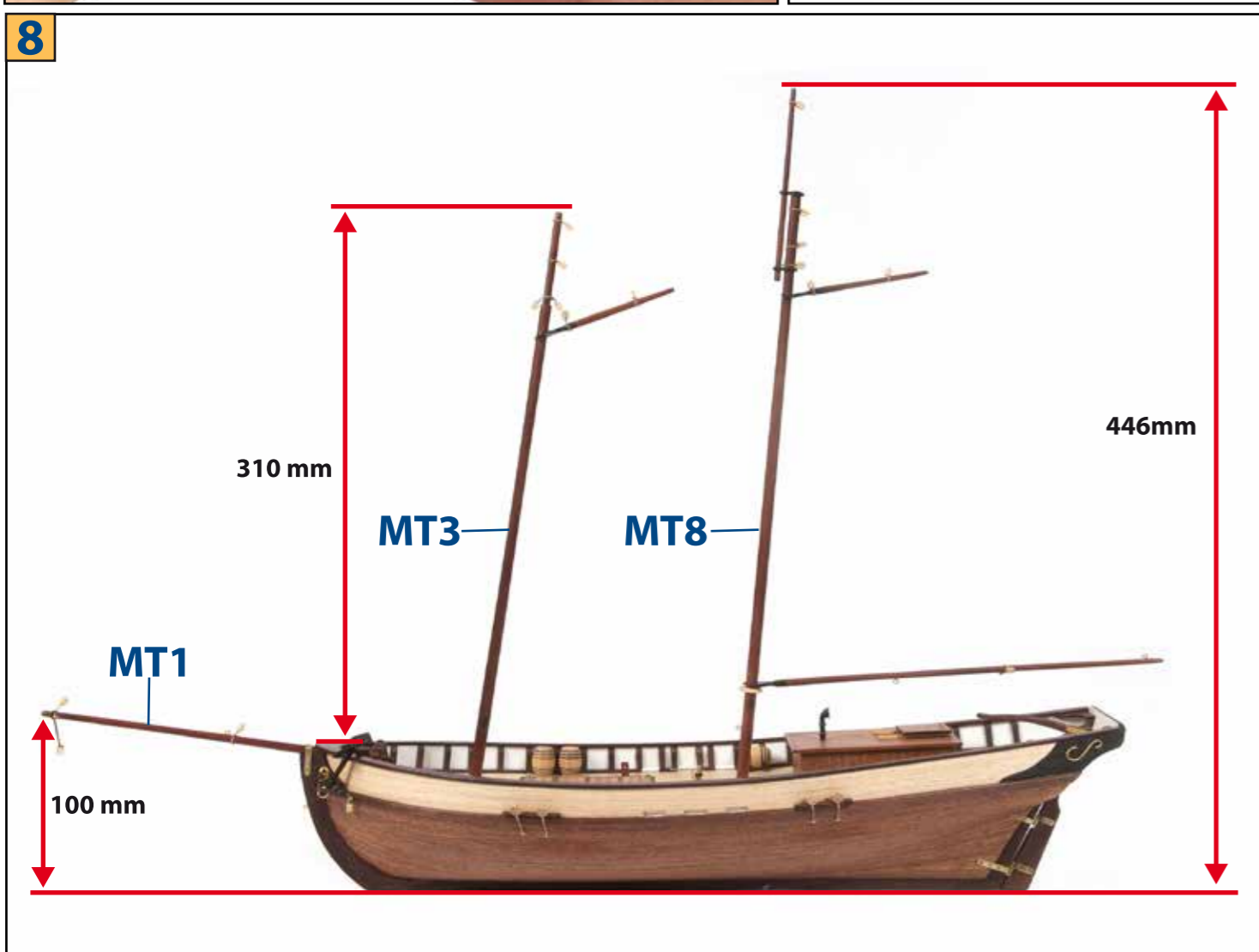
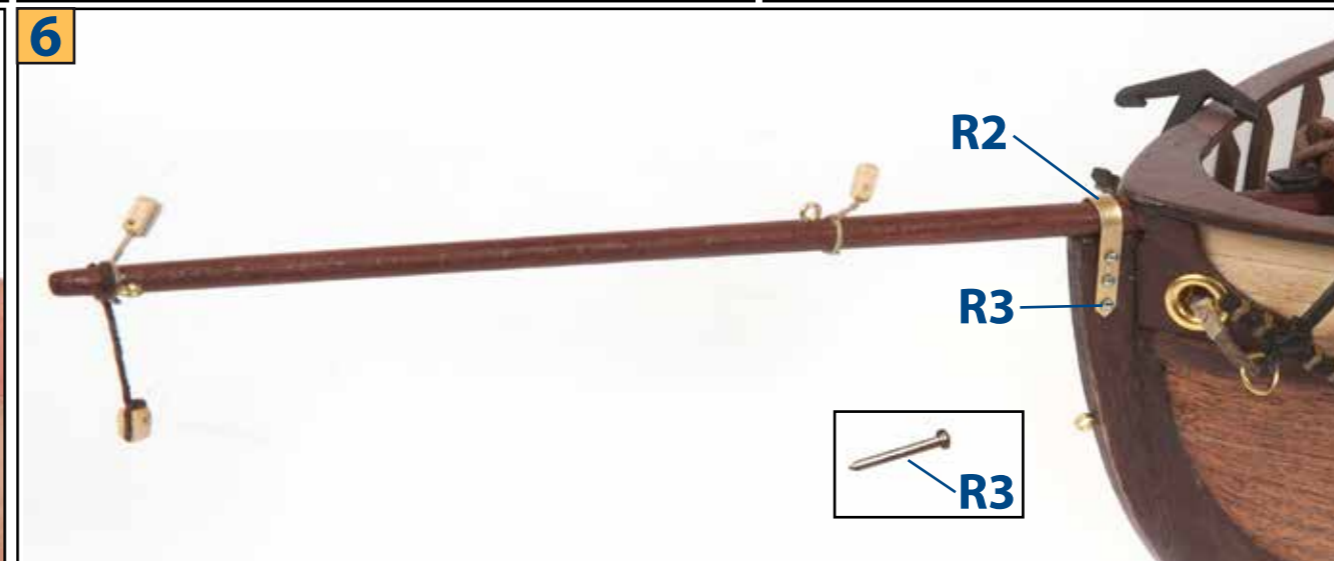
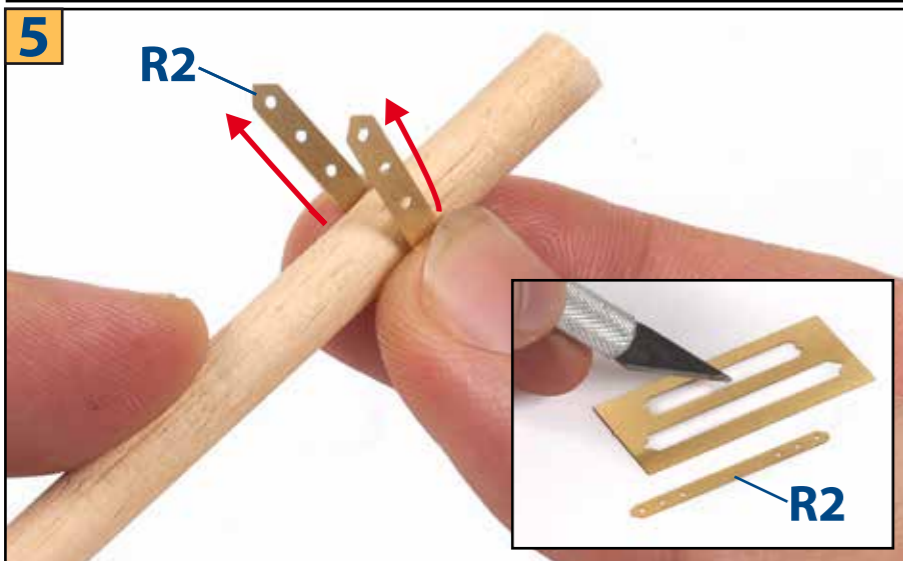
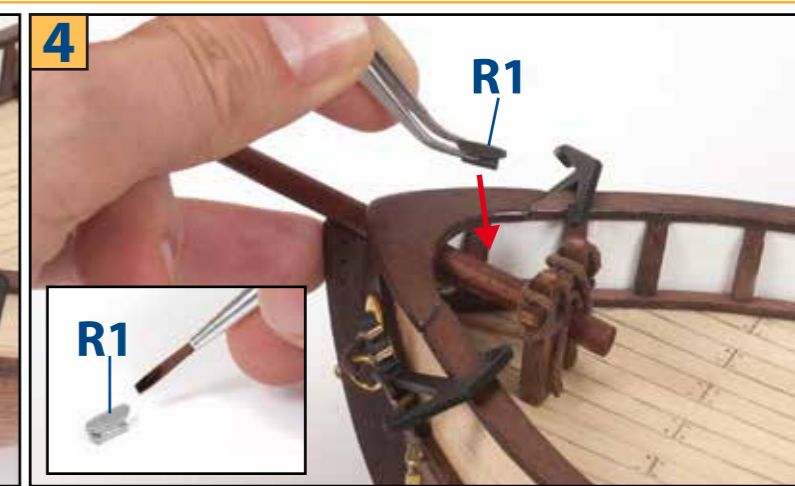
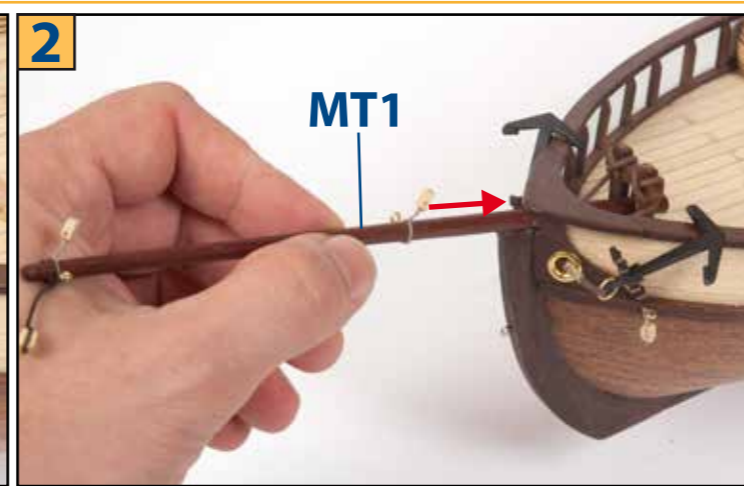
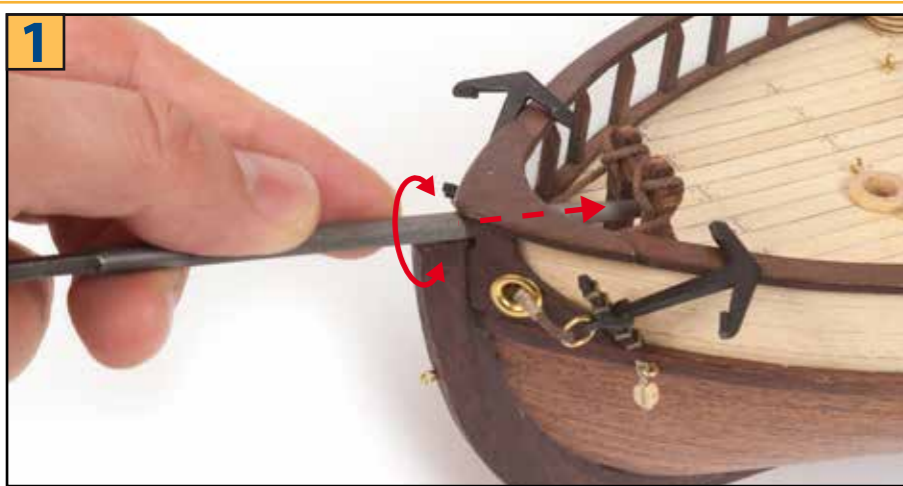

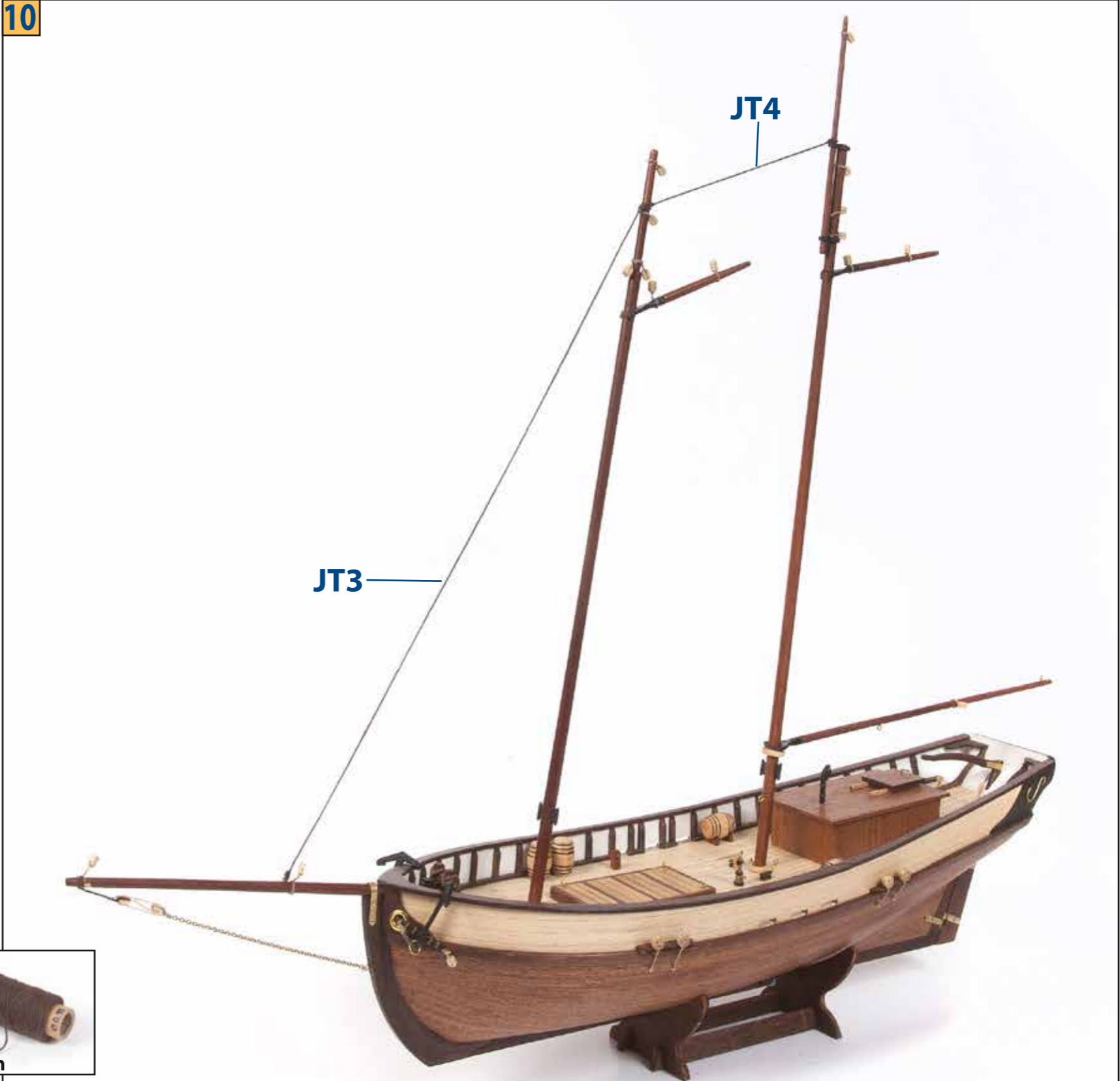
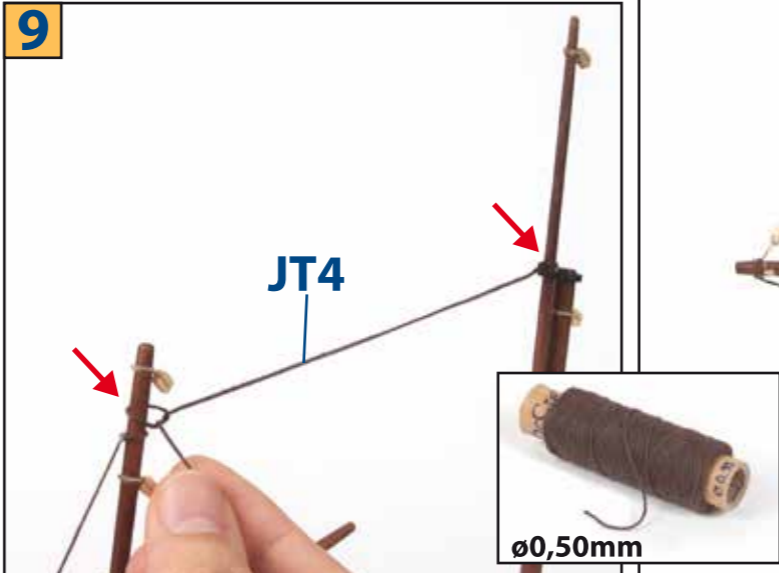
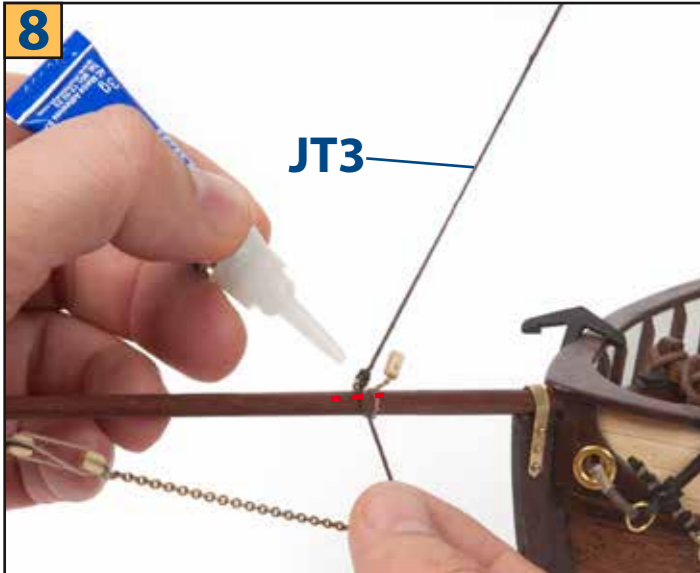
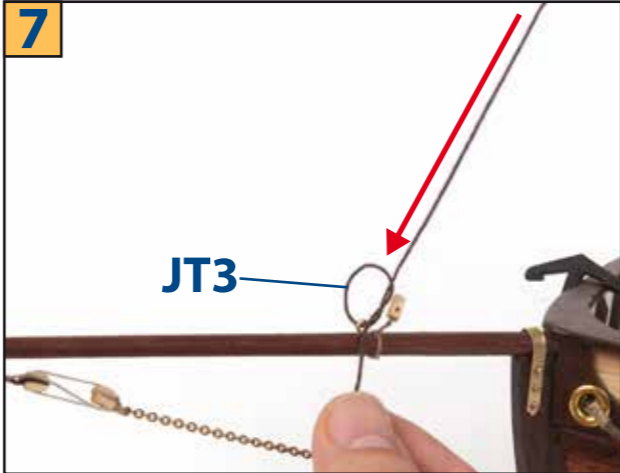
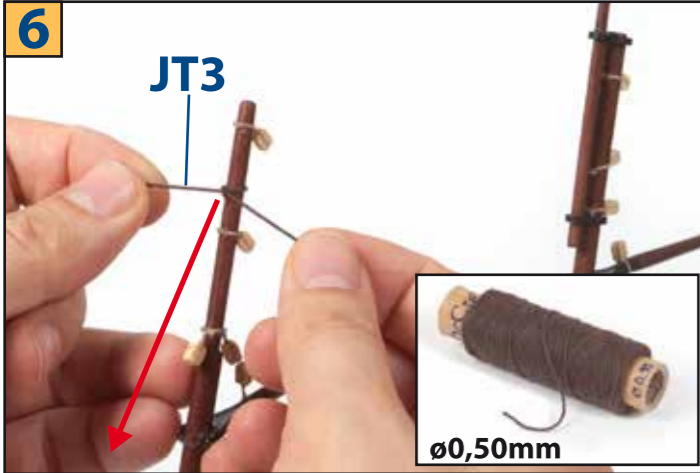
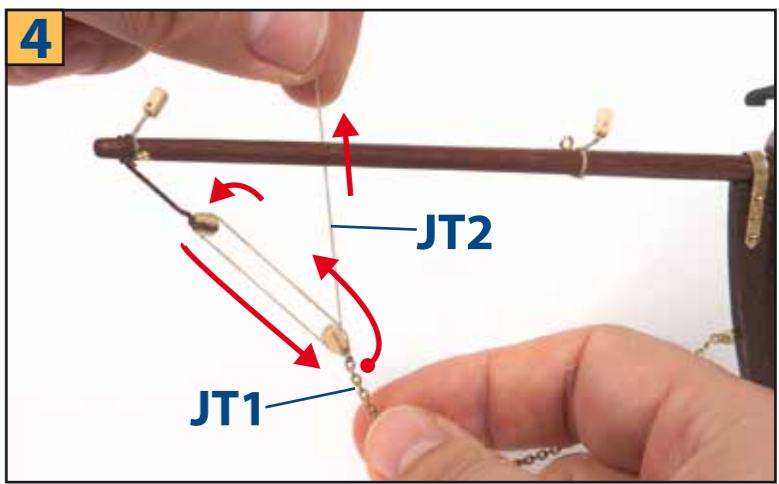
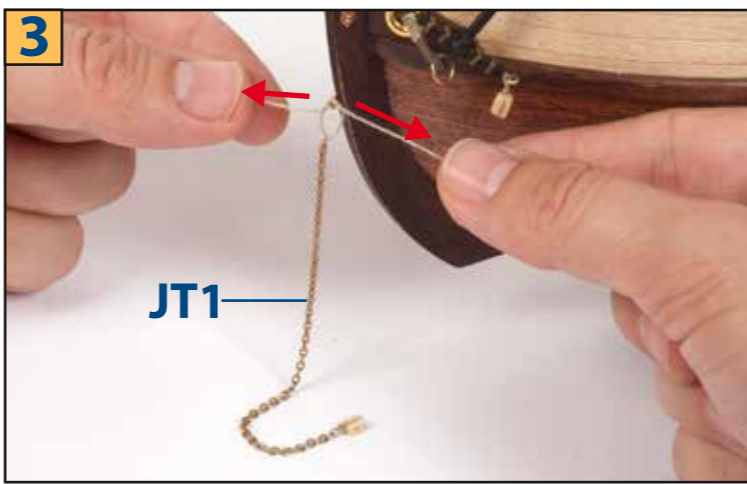
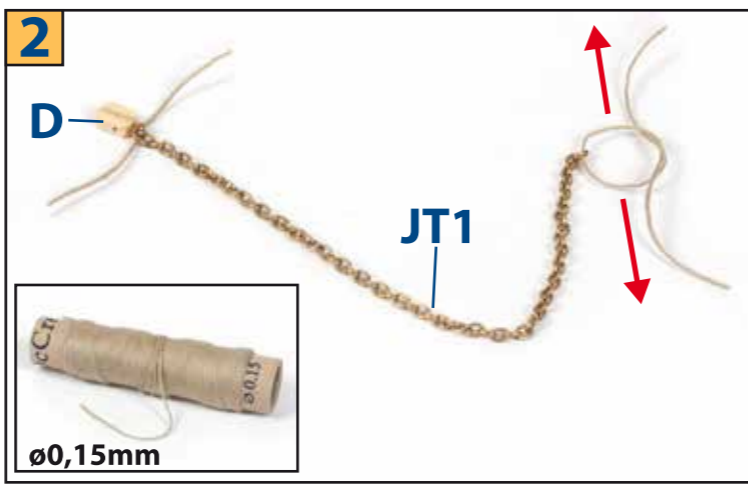

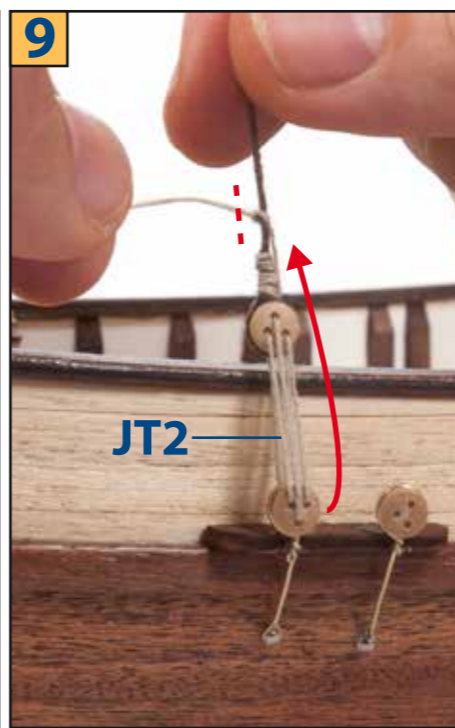
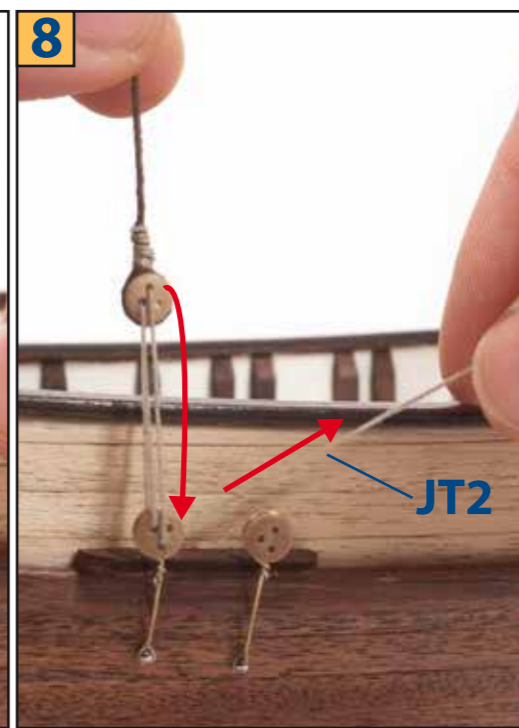
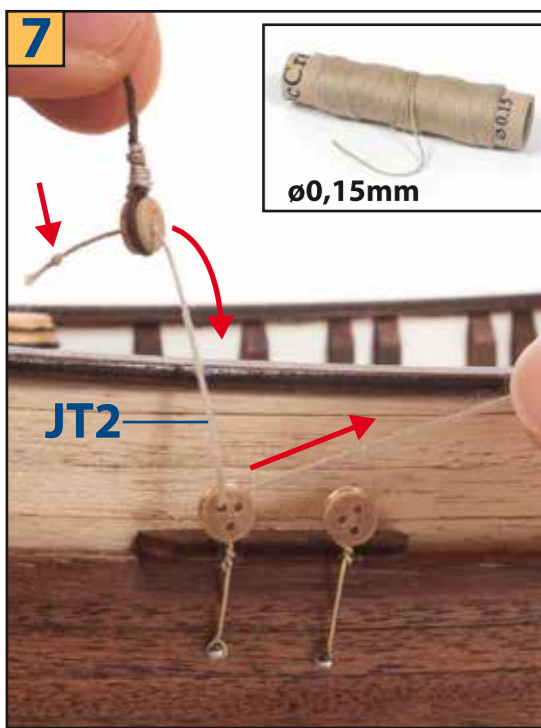
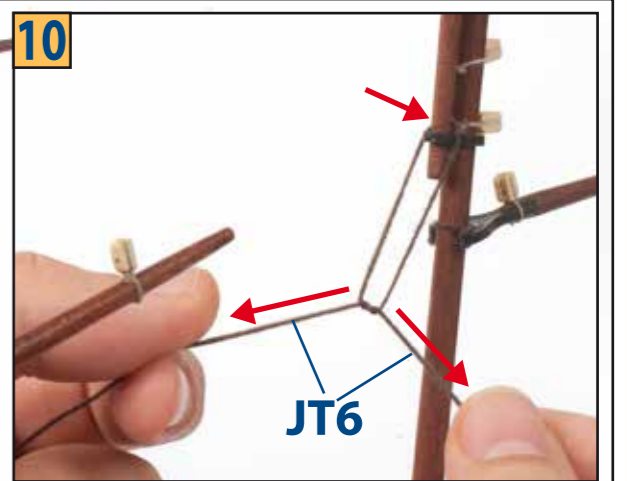
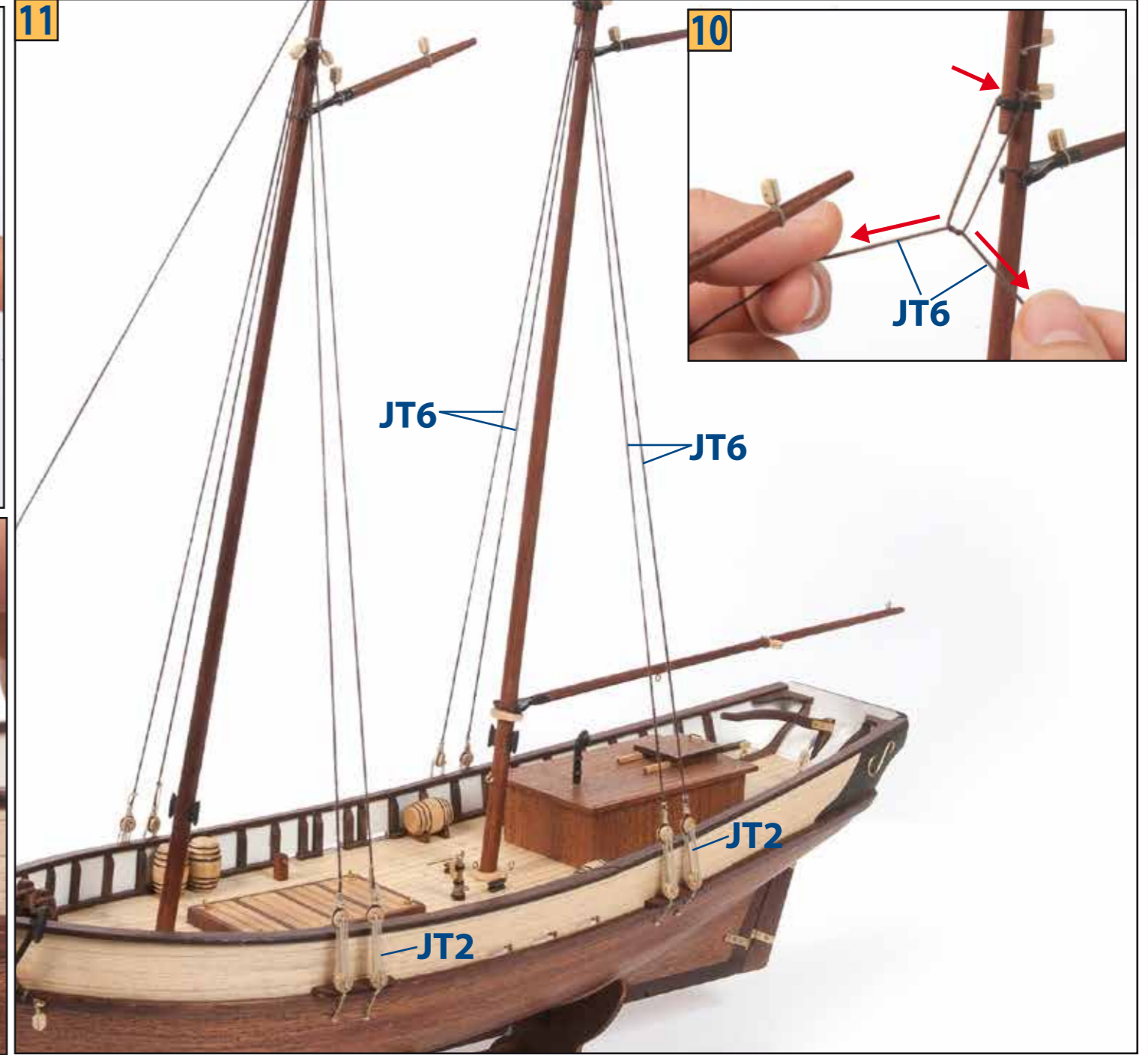
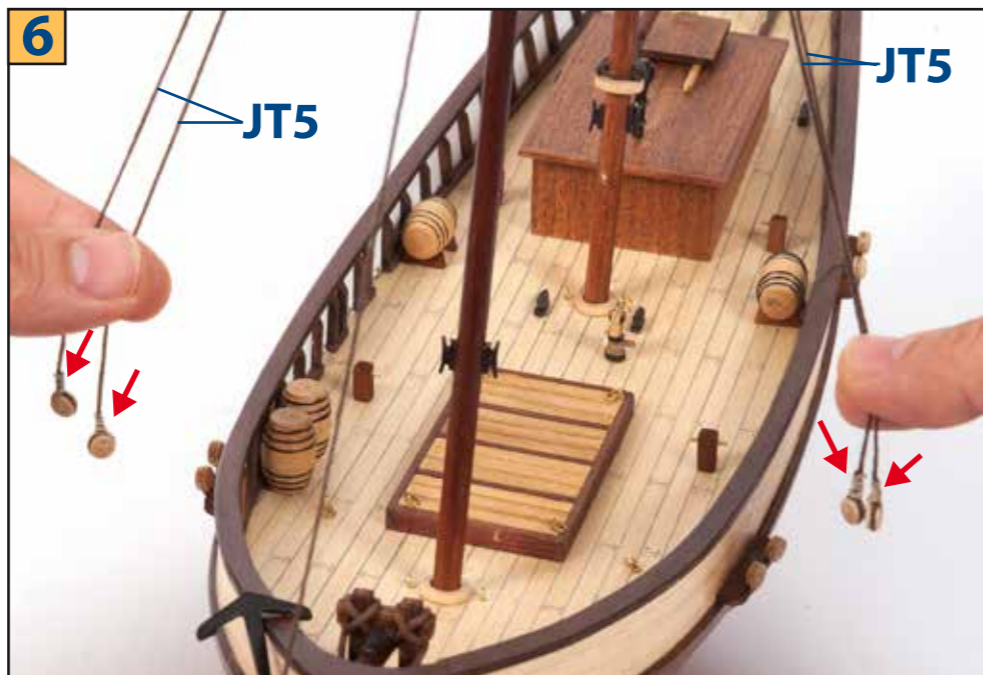
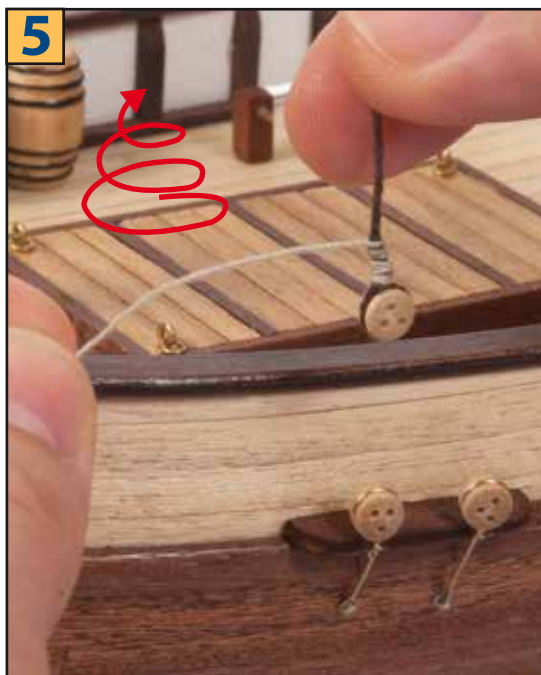
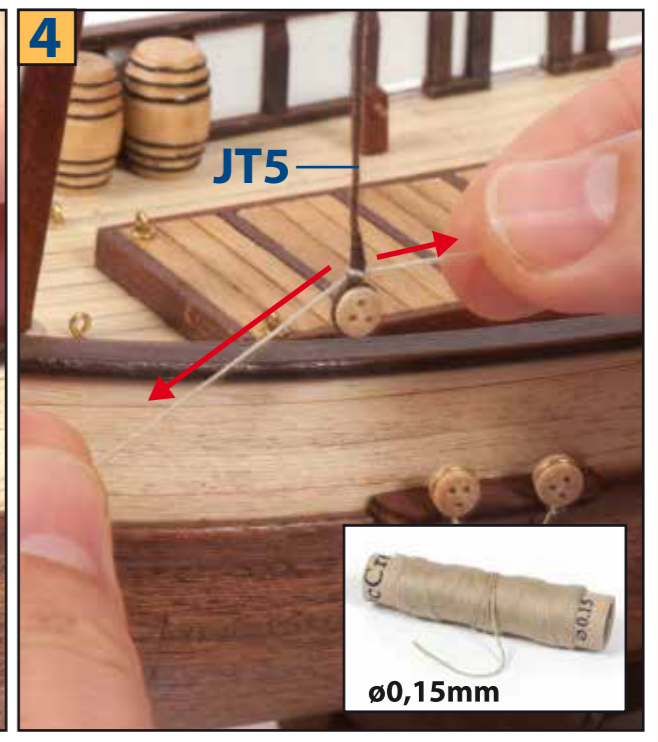
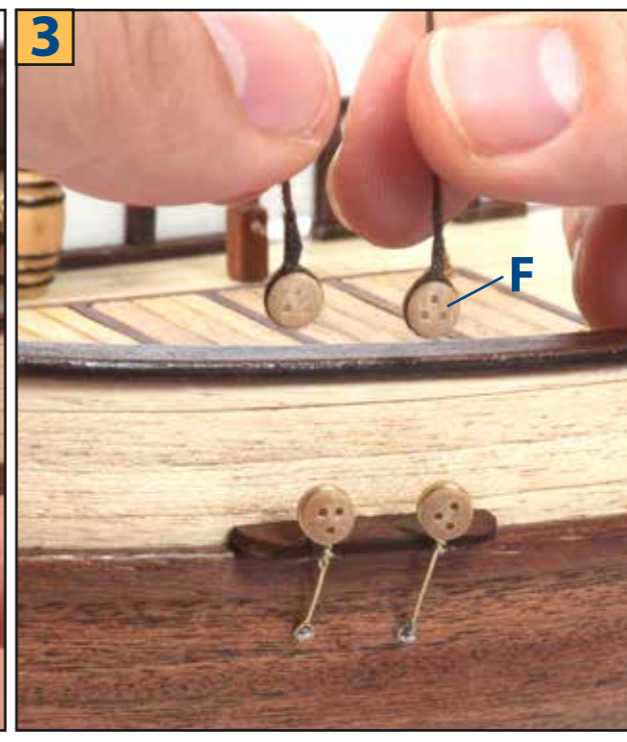
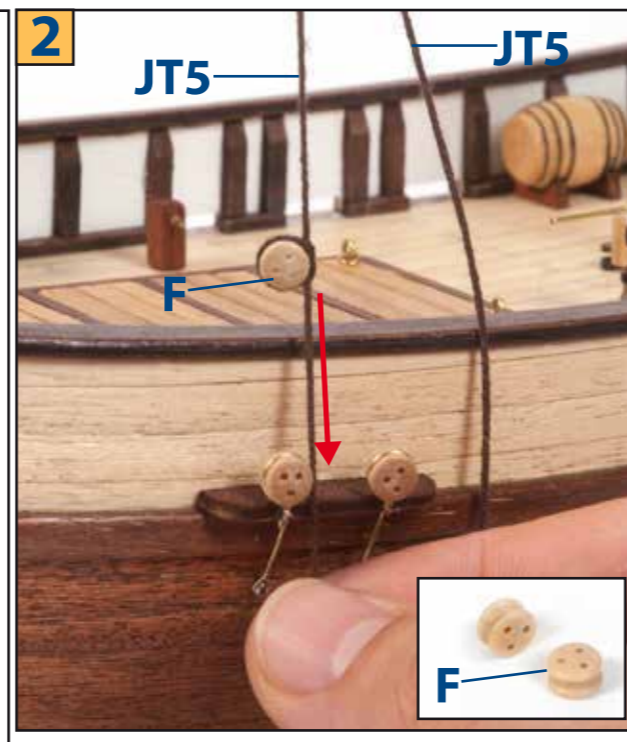
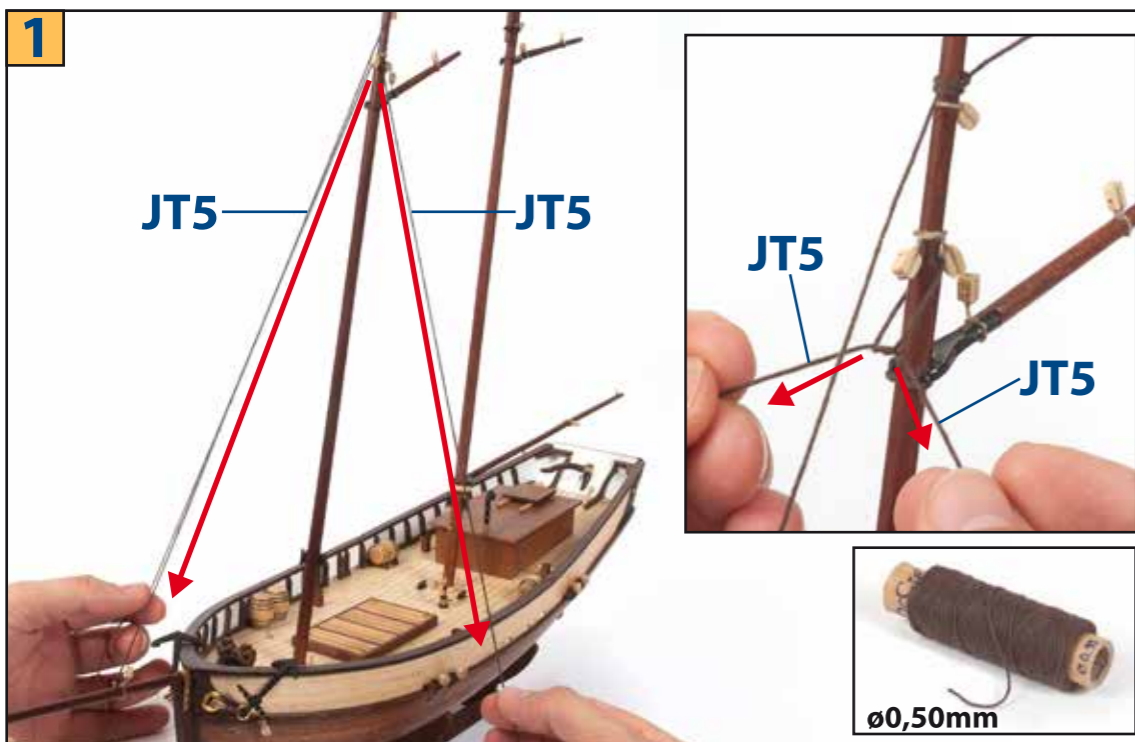

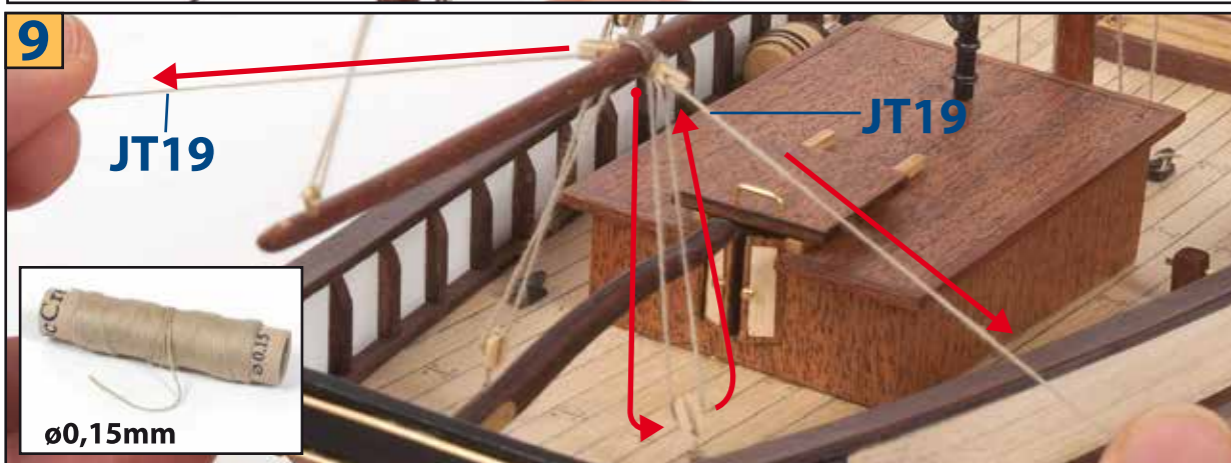
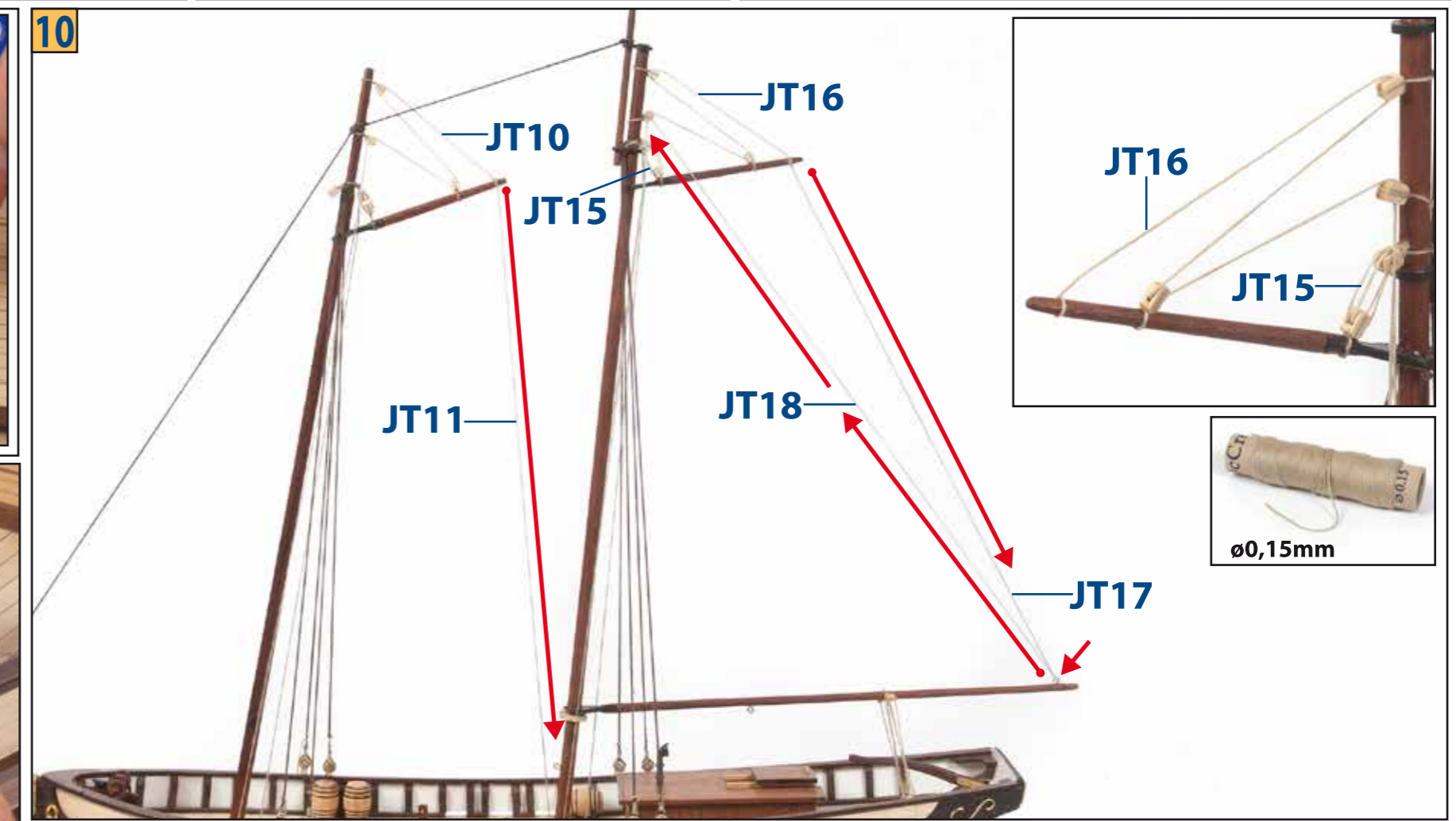
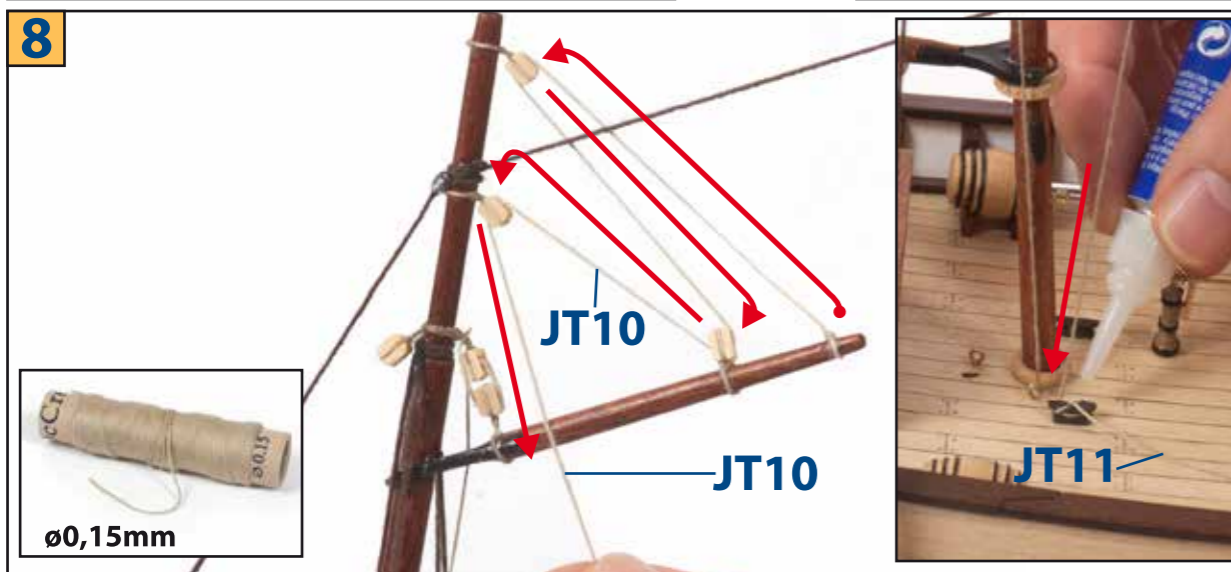
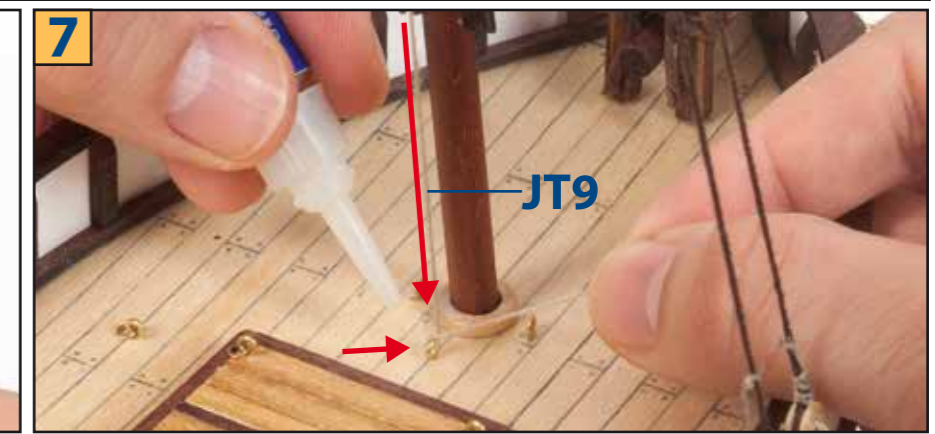
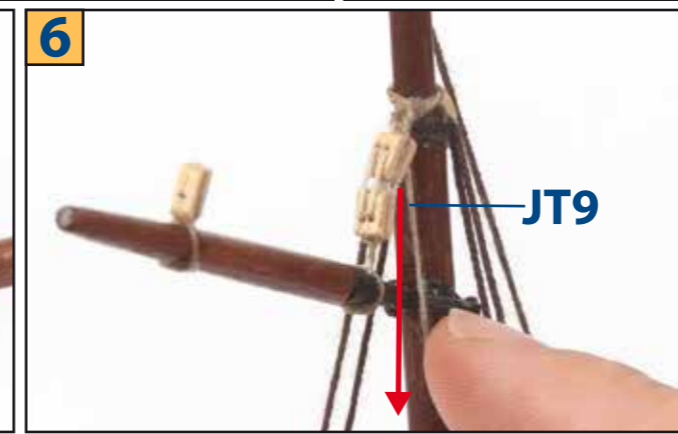
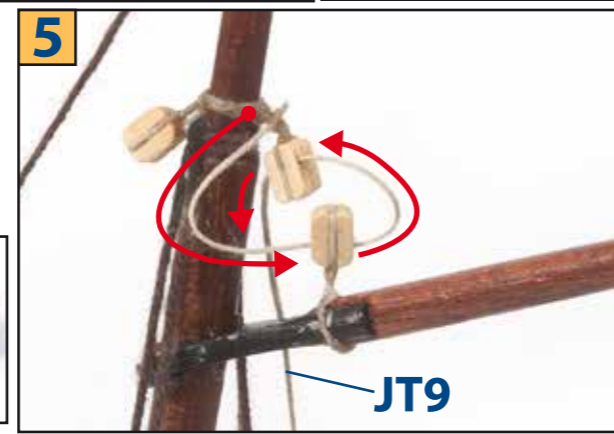
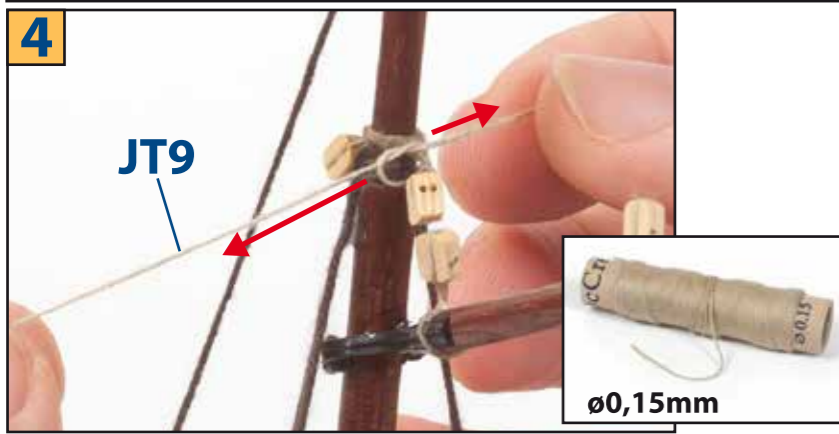
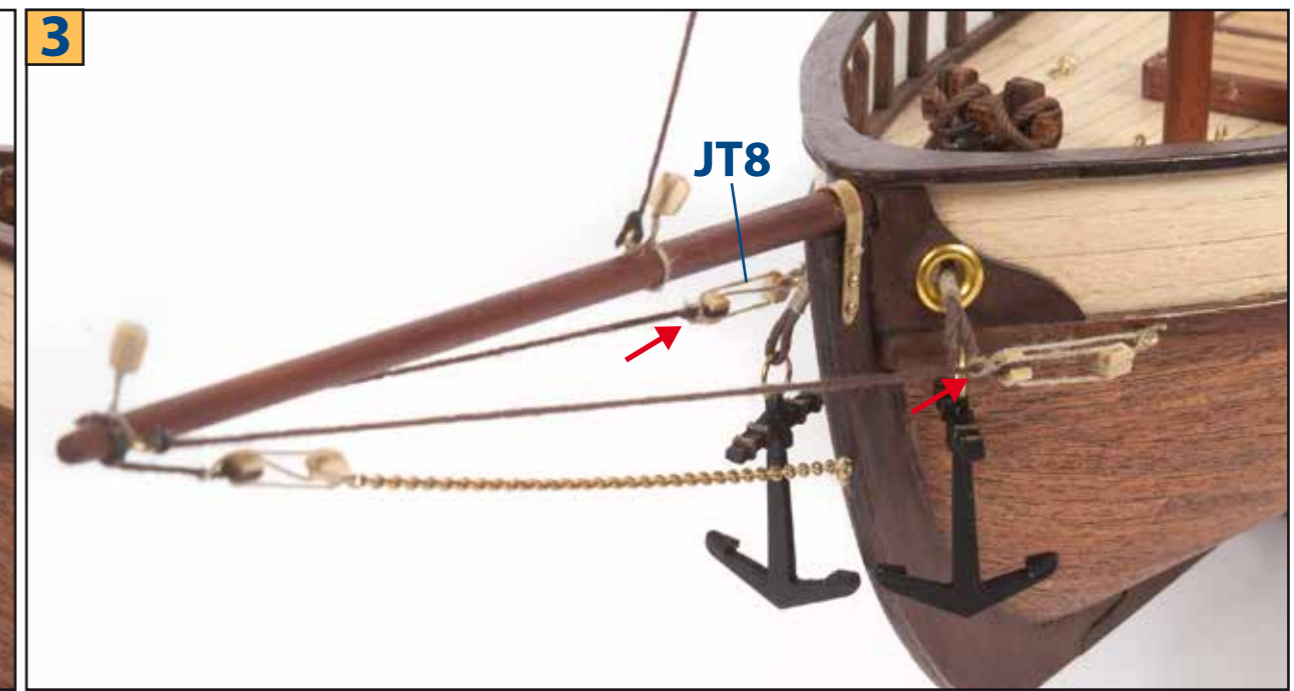
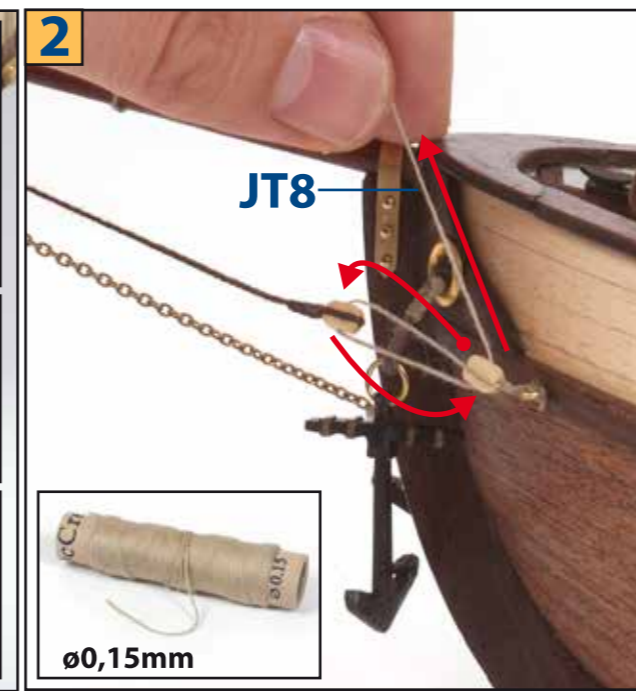
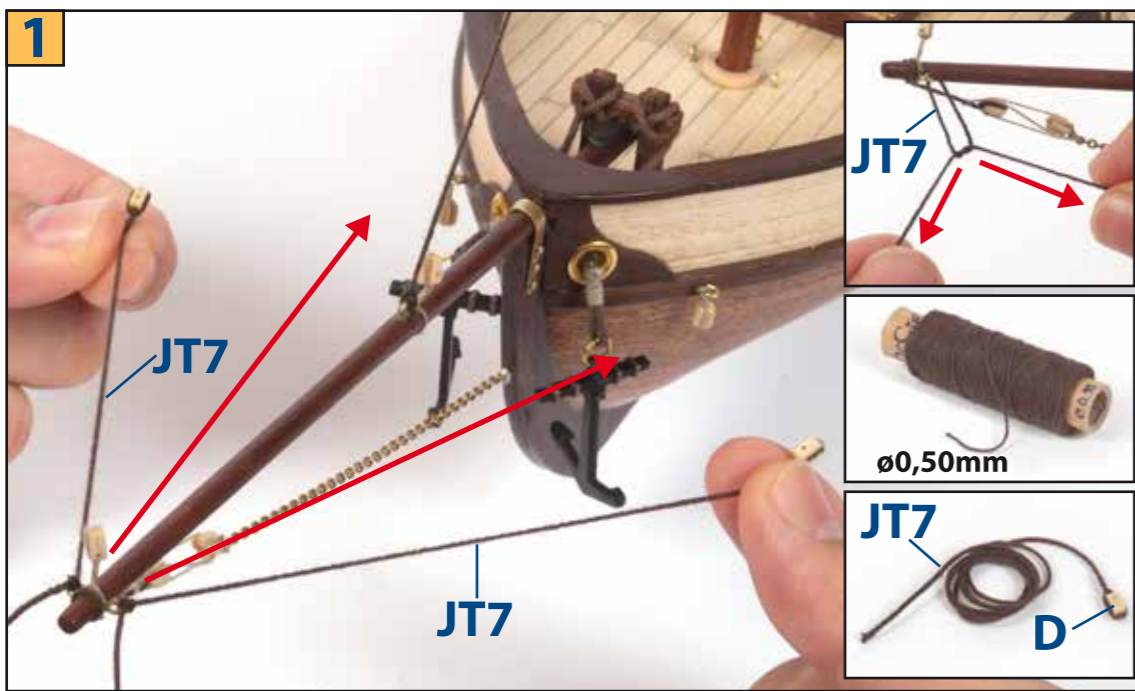

Velas / Sails / Voiles / Segelt / Vele

x1

x1

V4

V2

x1

V1

V3

x1

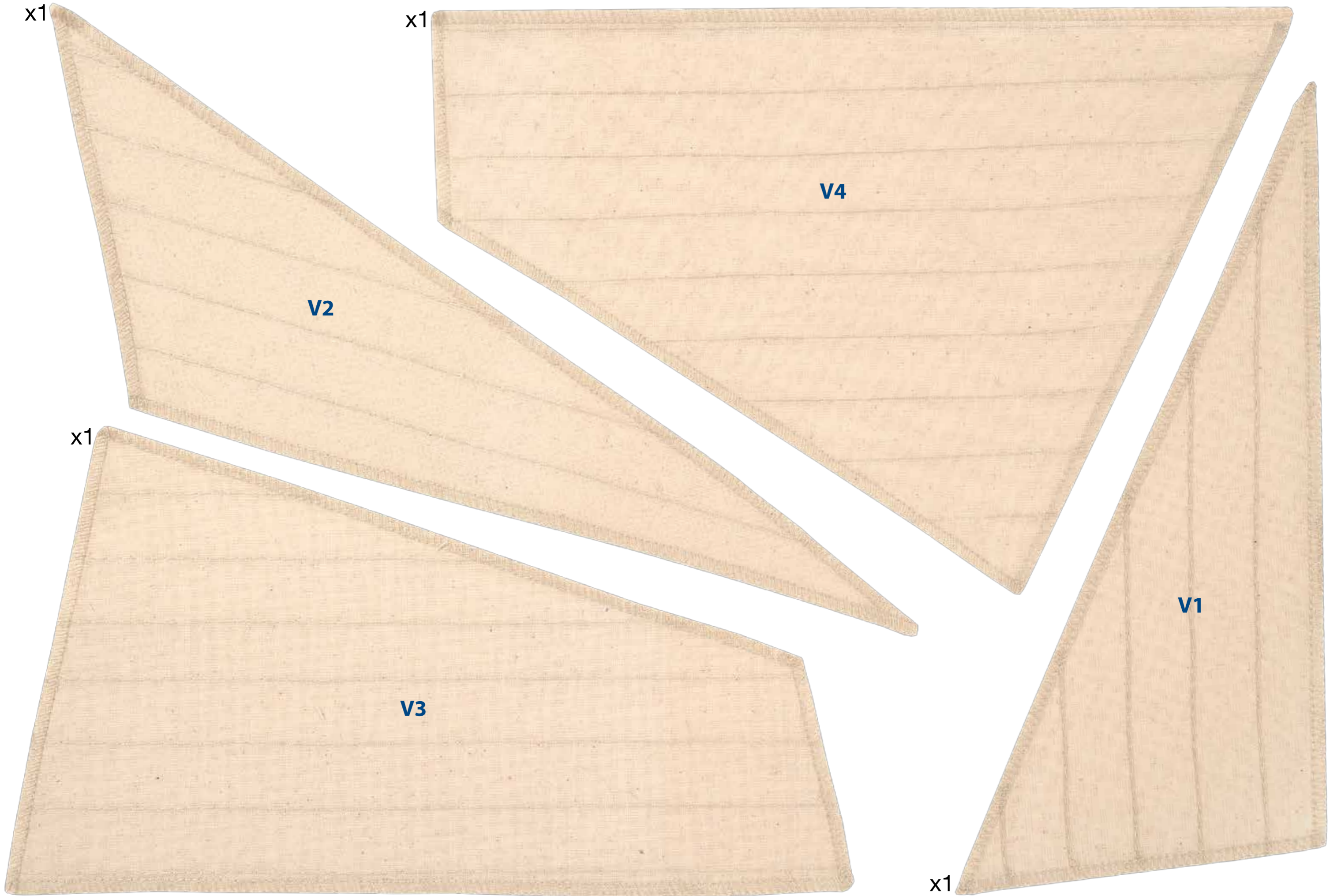

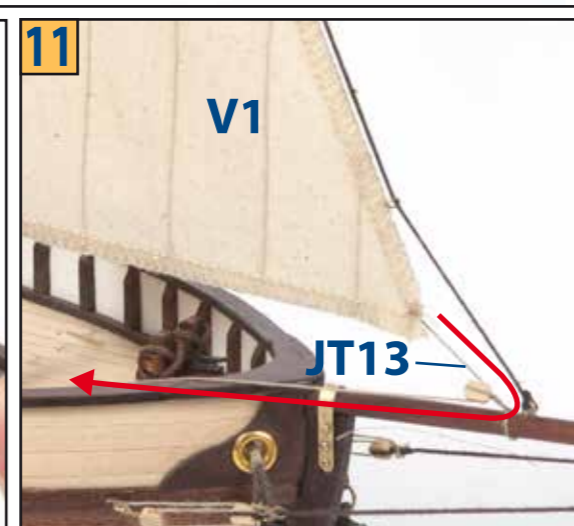
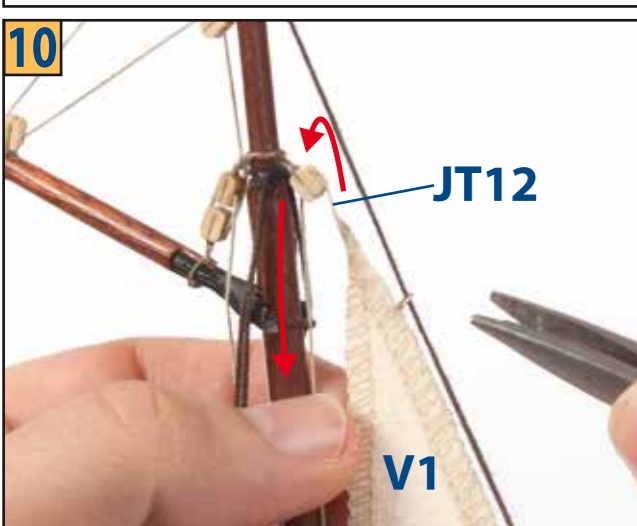
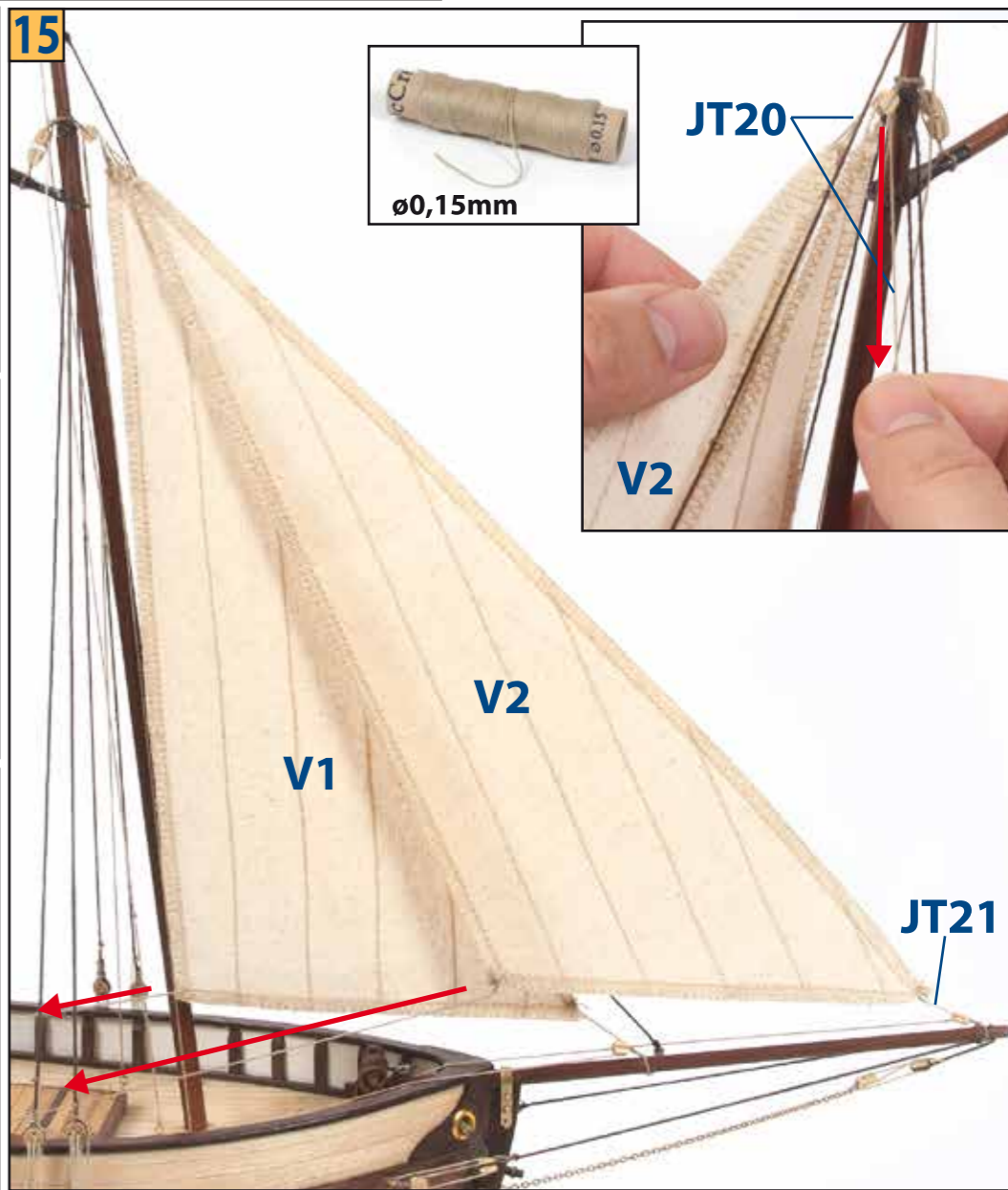
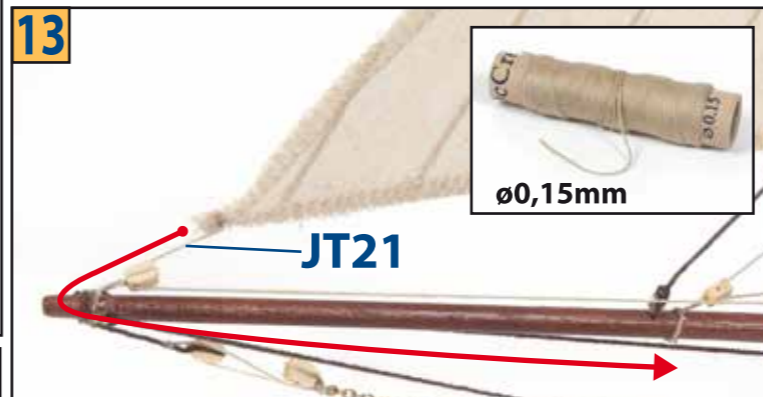
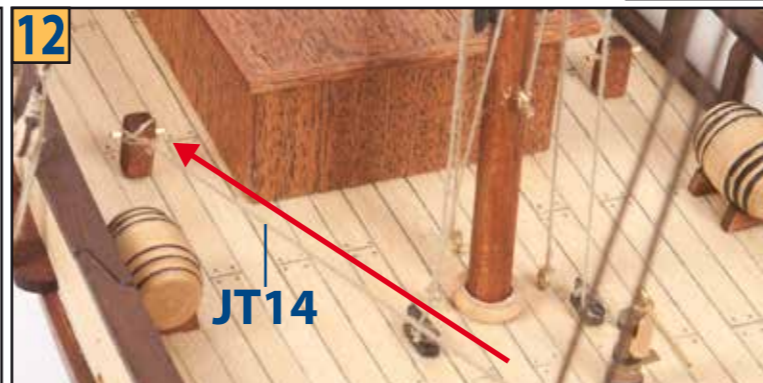
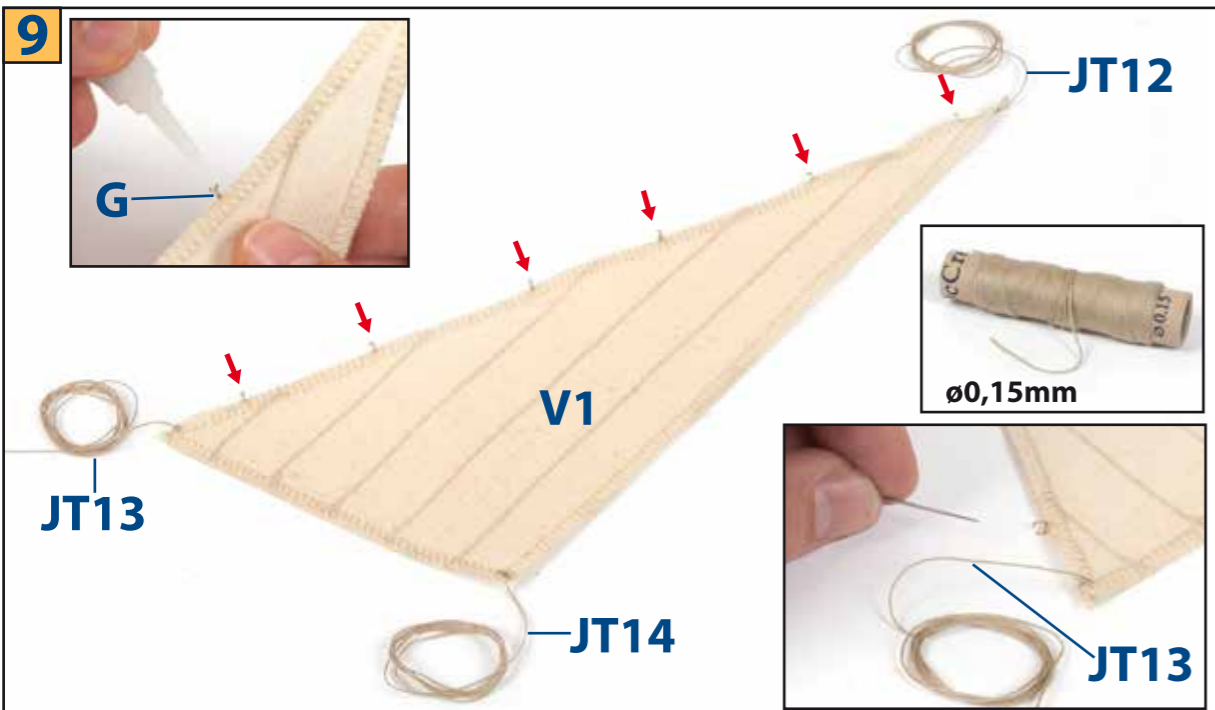
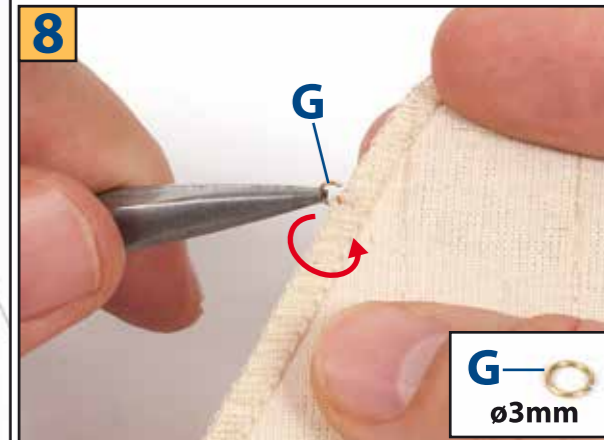
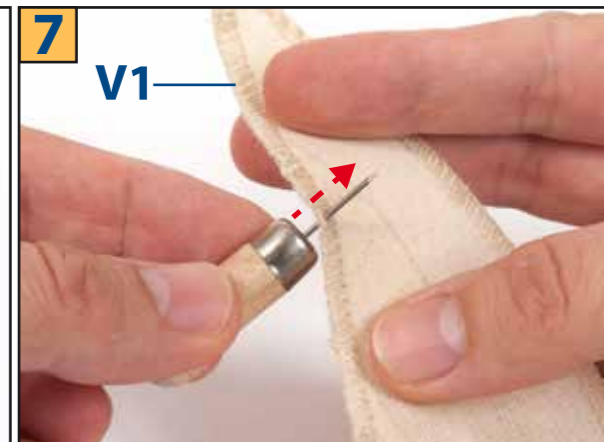
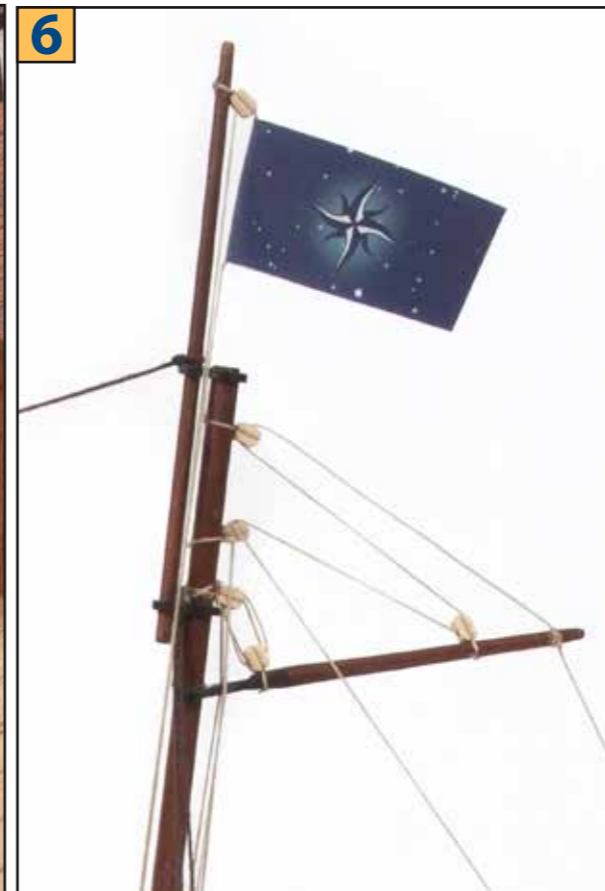
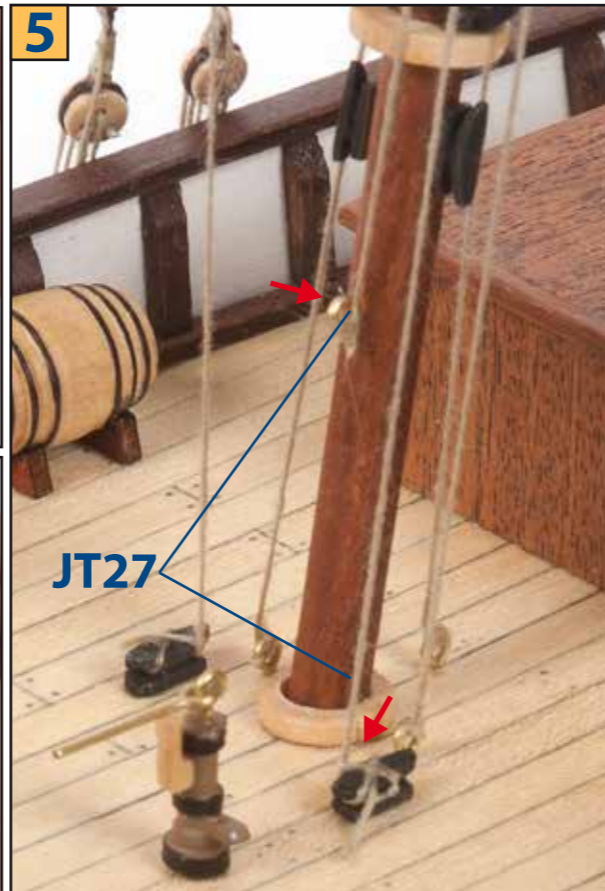
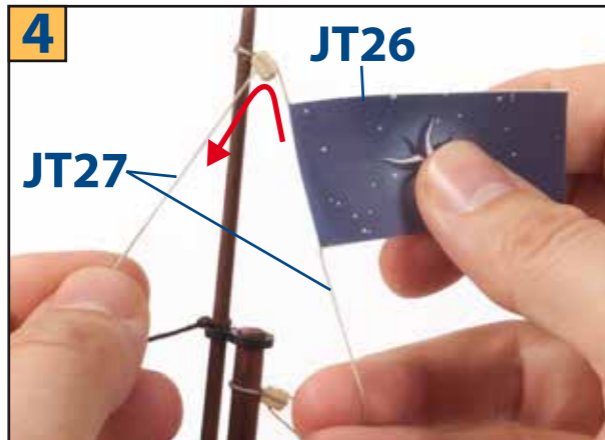
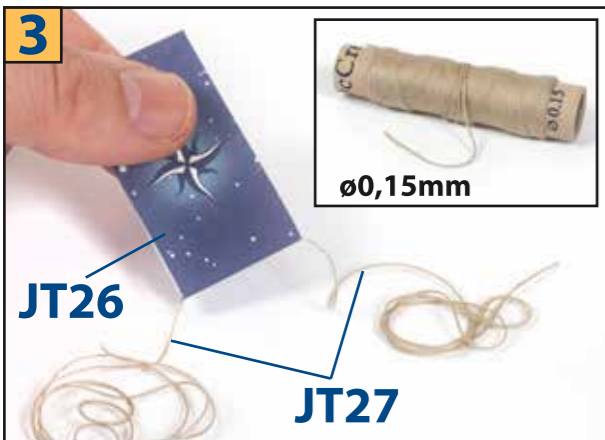
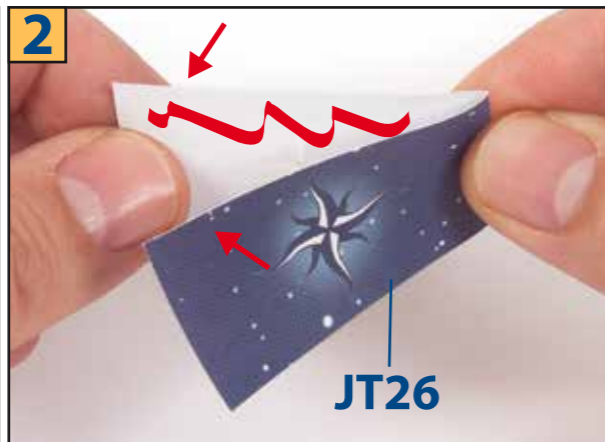
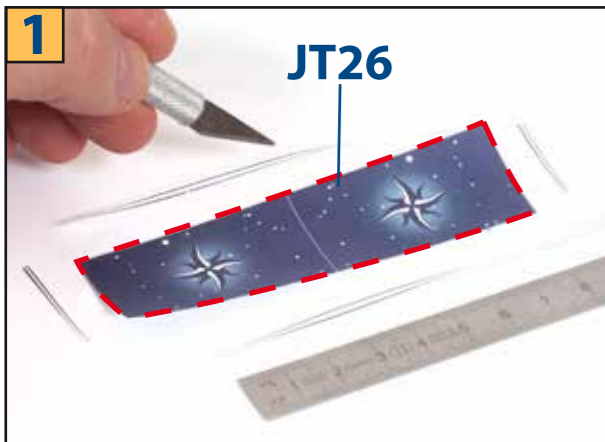

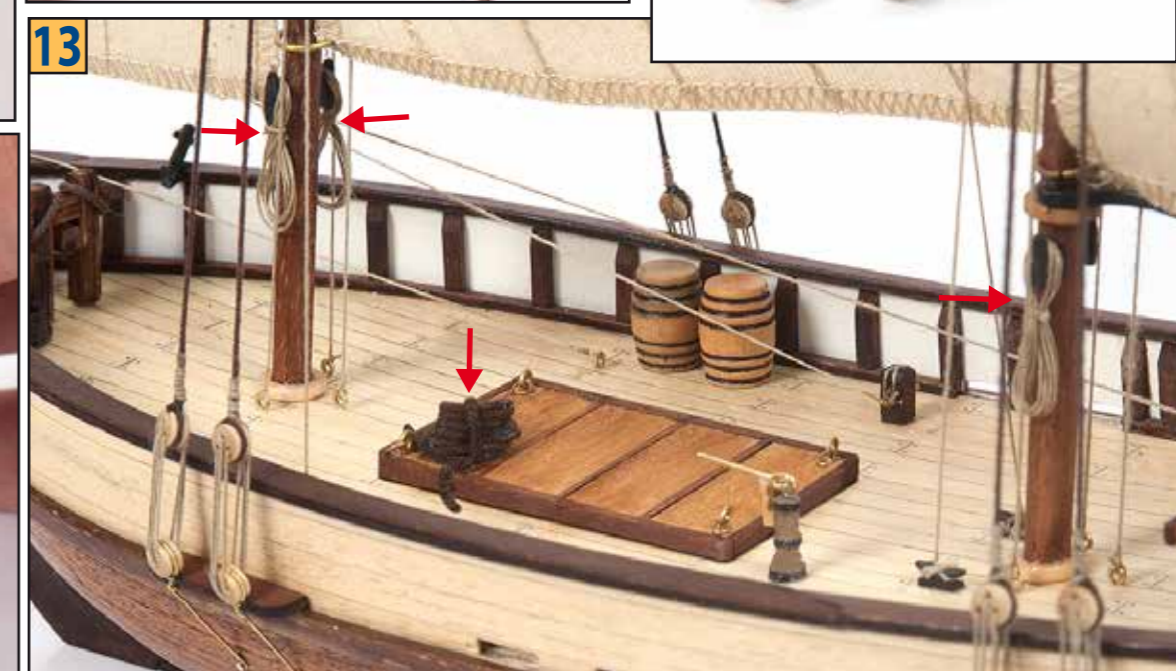
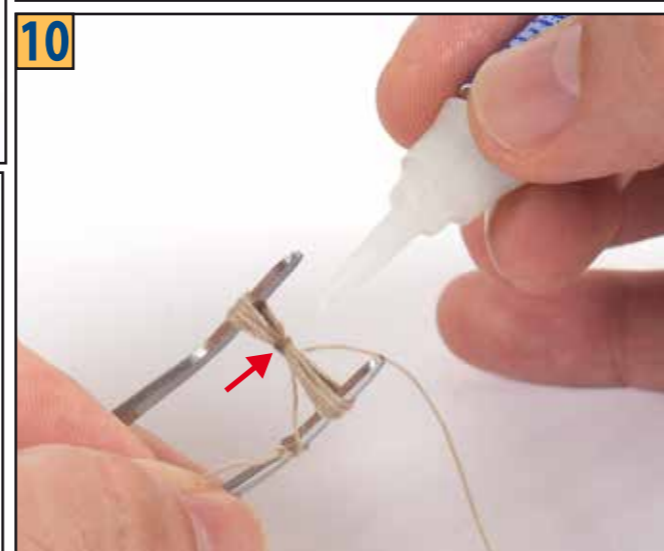
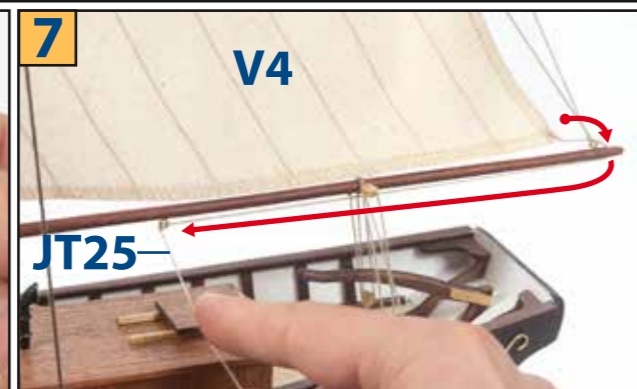
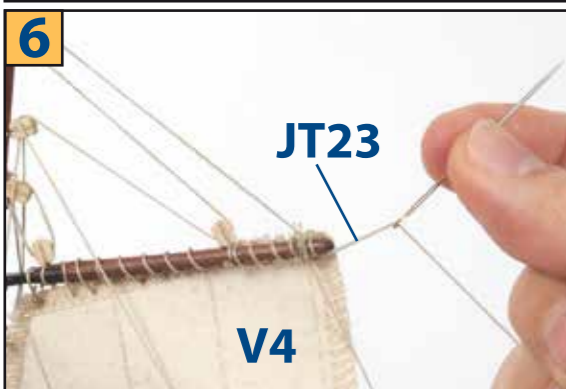
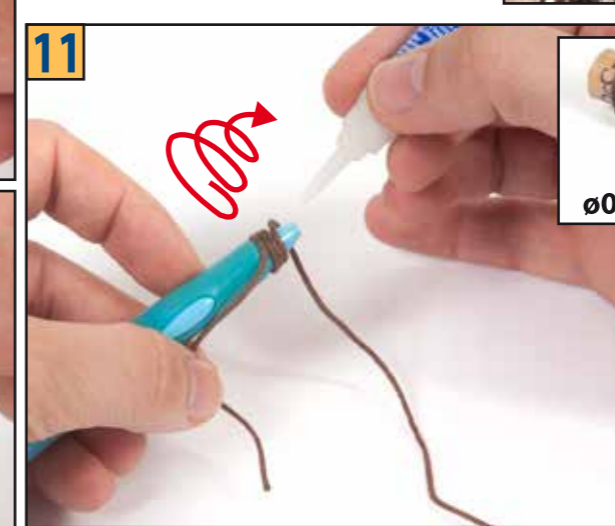
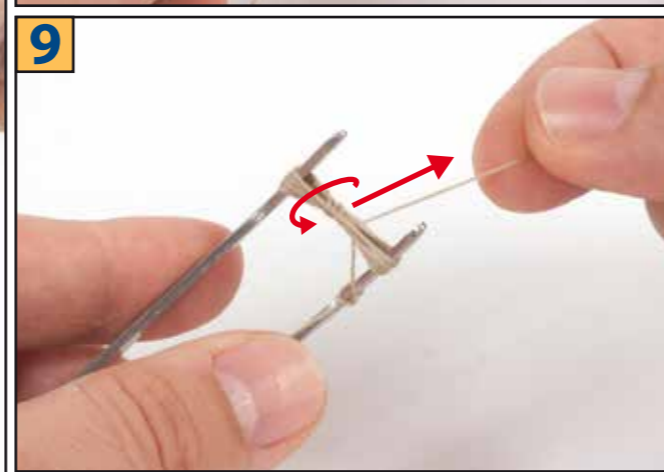
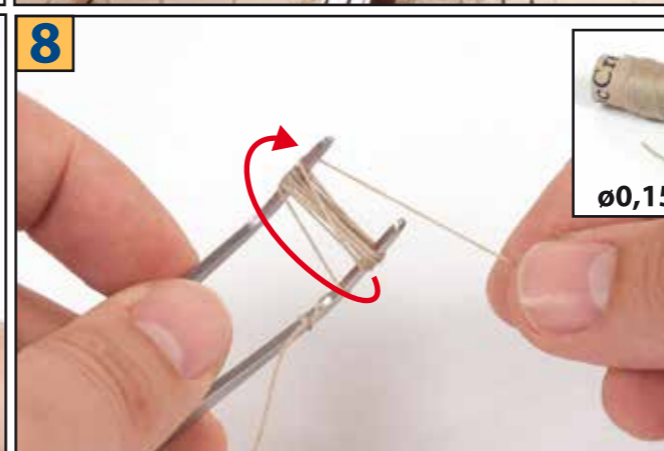
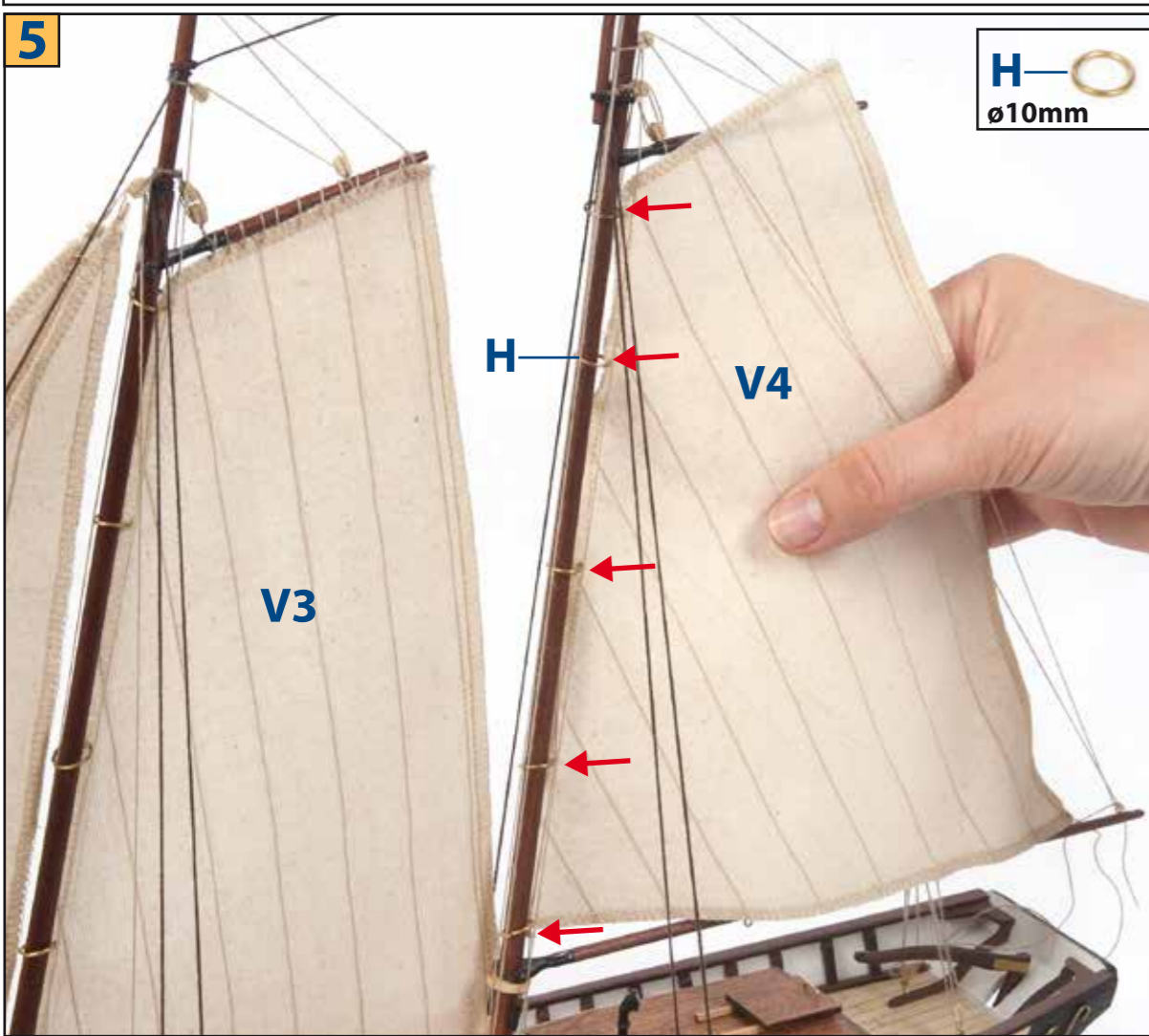
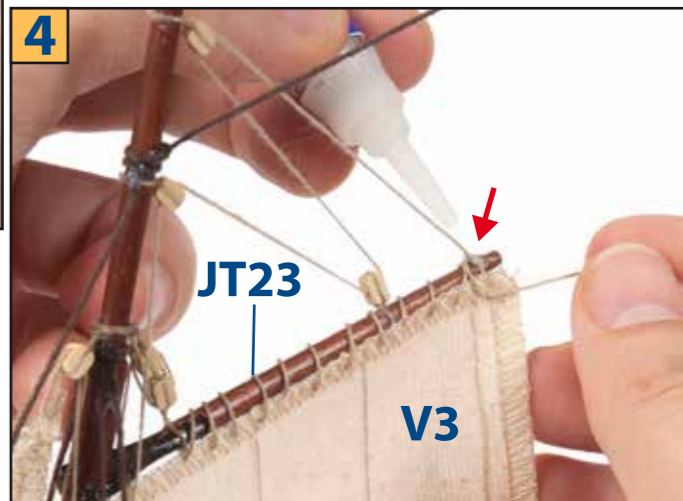
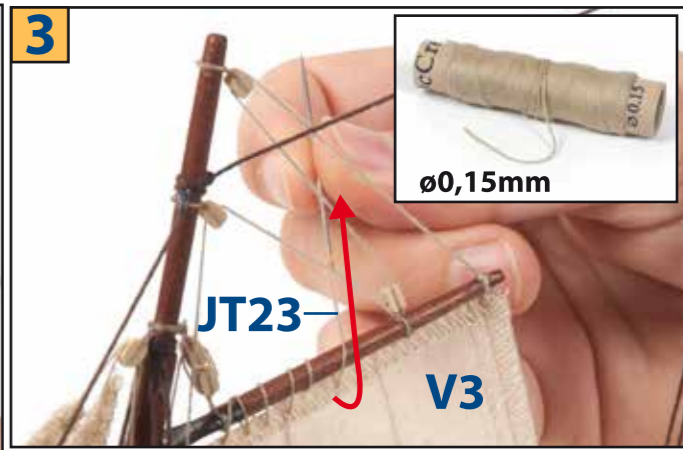
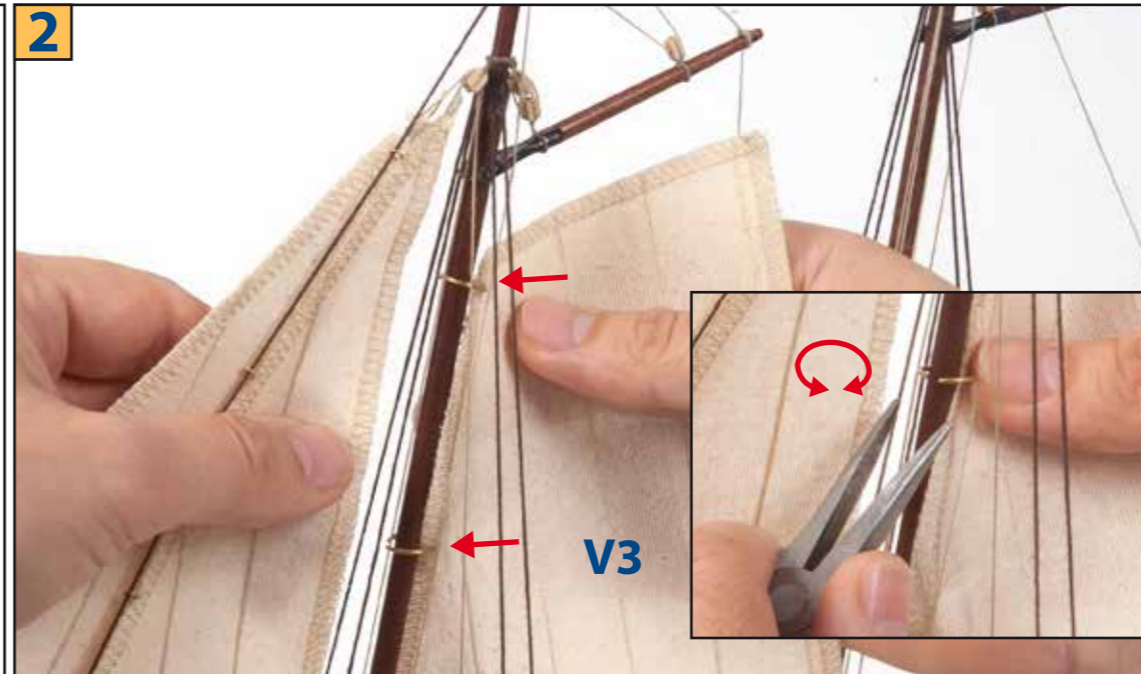
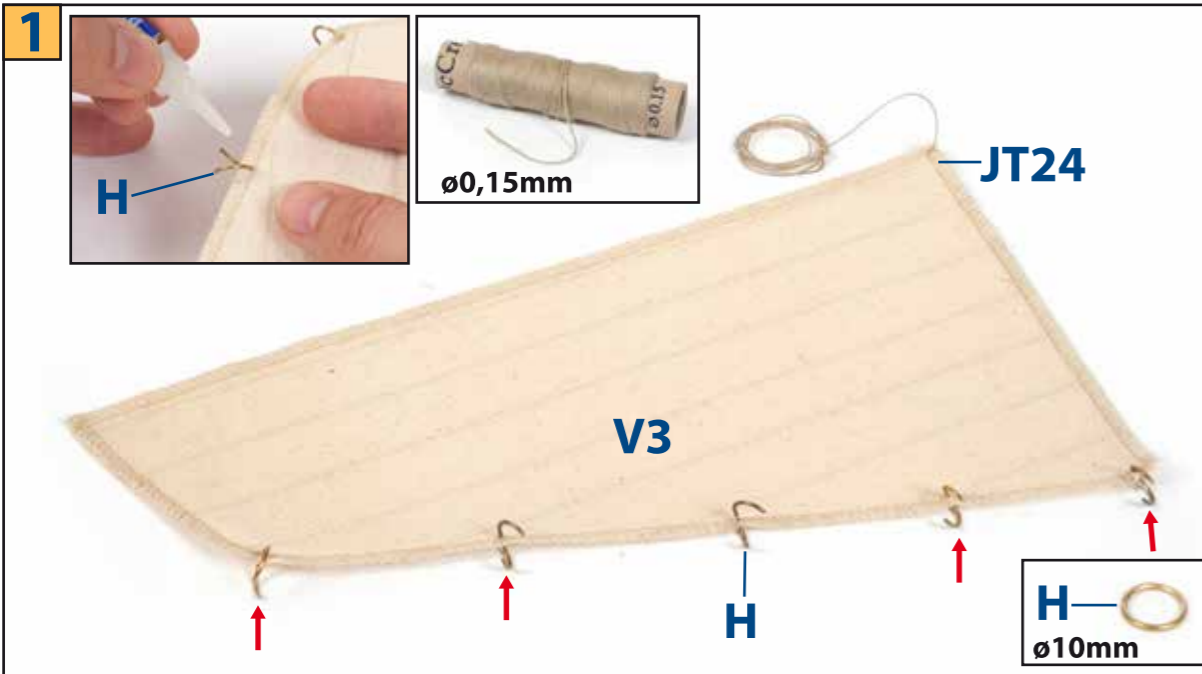



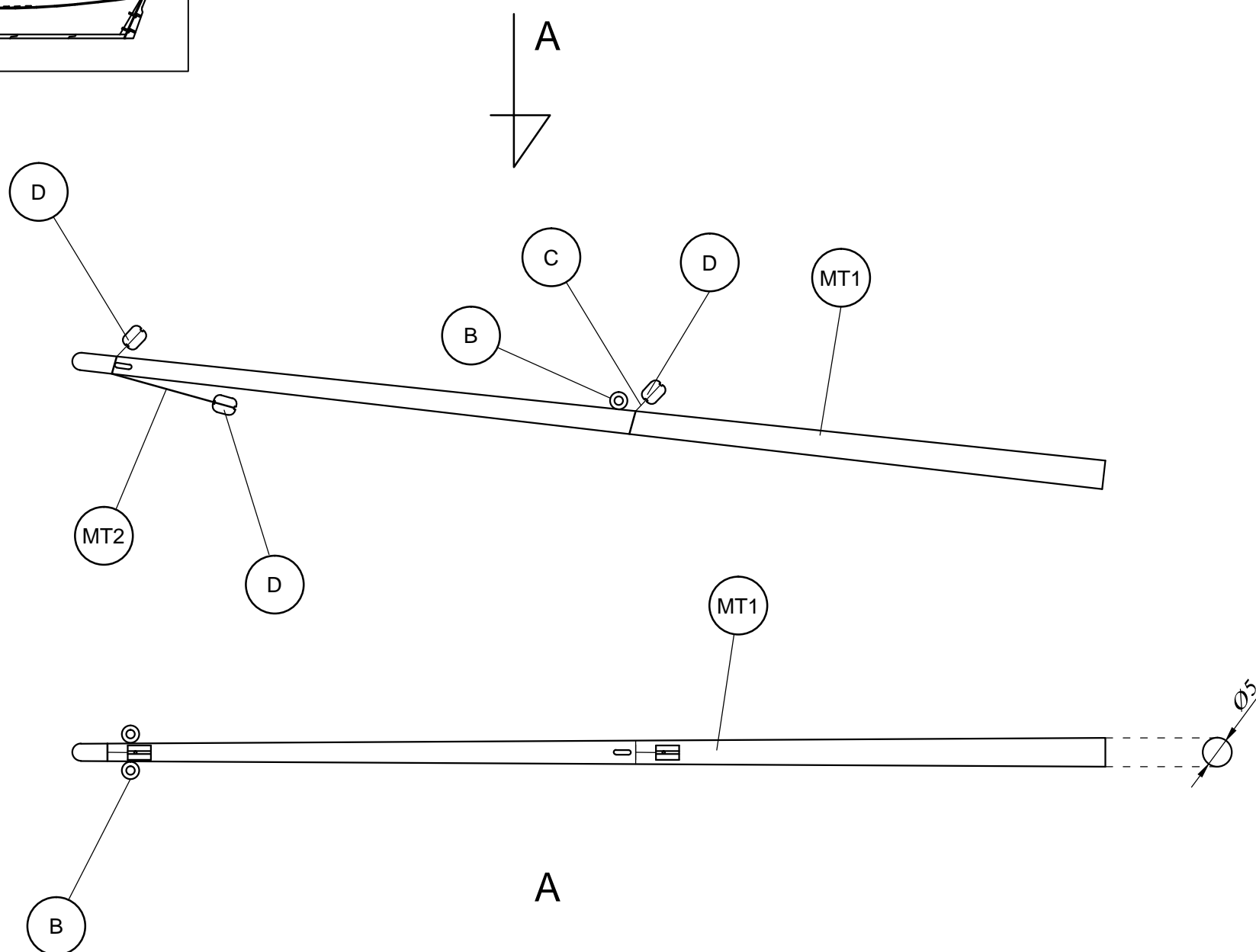
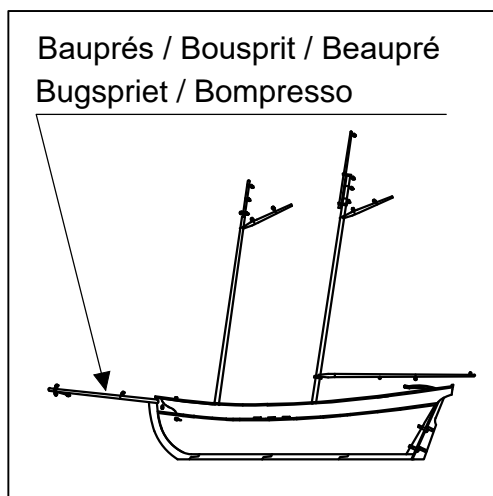

Nº/No./ N° / Nr. / No	Medidas / Measurements / Dimensions / Maße / Misure	Material / Material / Matériau / Material / Materiale
MT1	ø5x180	Tilo / Lime wood / Tilleul / Linde / Tiglio
MT2	ø0,50x110	Hilo marrón / Brown thread / Fil brun / braunes Baumwollfaden / Filo marrone
B	15	Latón / Brass / Laiton / Messing / Ottone
C	ø0,15x100	Hilo crudo / Raw thread / Fil brut / Rohes Baumwollfaden / Filo crudo
D	4	Composite / Composite / Composite / Composite / Composite

Scale 1/1



B

Cáncamo
Eyebolts
Piton à oeil
Tragöse
Caviglia di ferro ad anello



D

Moton
Blocks
Poulie
Blockrolle
Bozzello



E

Cuadernal
Double blocks
Poulie double
Block
Pastecca



F

Vigota
Dead eyes
Cap de mouton
Jungfernblock
Bigotta



G-H

Anilla
Rings
Oeil
Öse
Anello

Polaris

Palo trinquete / Fore mast / Mât de misaine
Fockmast / Albero trinchetto

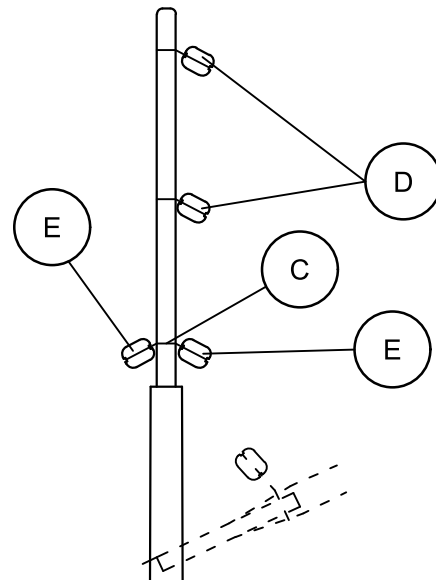
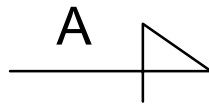
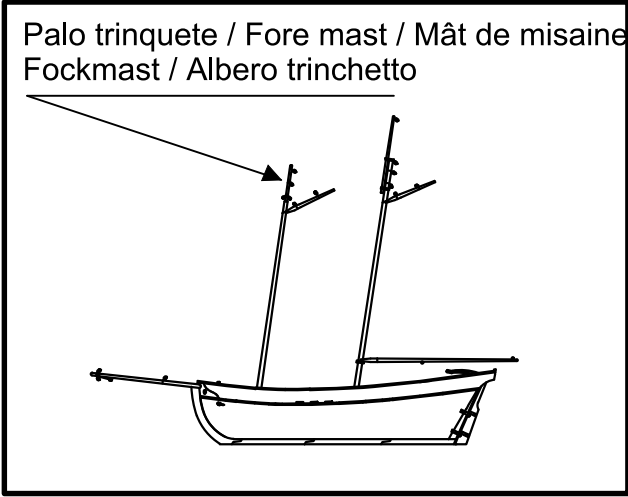

MT3

MT3

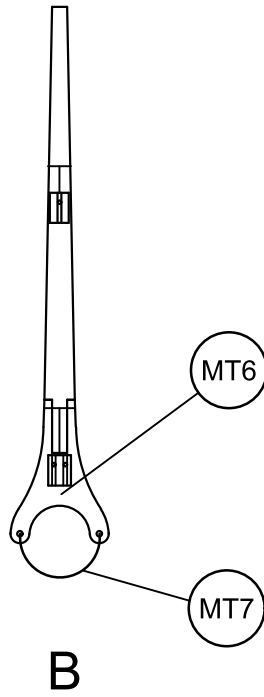
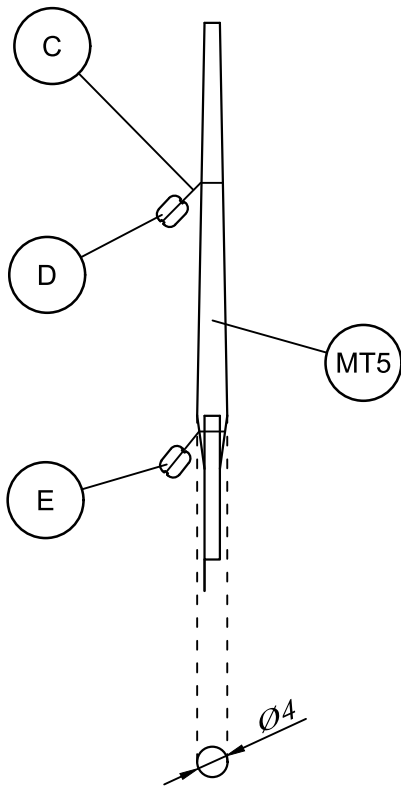
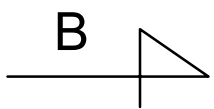

B

MT4

MT4

A

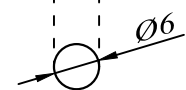

Scale 1/1

Nº/No./ N° / Nr. / No	Medidas / Measurements / Dimensions / Maße / Misure	Material / Material / Matériau / Material / Materiale	Nº/No./ N° / Nr. / No	Medidas / Measurements / Dimensions / Maße / Misure	Material / Material / Matériau / Material / Materiale
MT3	ø6x340	Tilo / Lime wood / Tilleul / Linde / Tiglio	MT7	ø0,50x110	Hilo marrón / Brown thread / Fil brun / braunes Baumwollfaden / Filo marrone
MT4	Preformado / Preformed/ Préformé / Vorgeformt / Preformato	Metal / Metal / Metal / Metall / Metallo	C	ø0,15x100	Hilo crudo / Raw thread / Fil brut / Rohes Baumwollfaden / Filo crudo
MT5	ø4x60	Tilo / Lime wood / Tilleul / Linde / Tiglio	D	4	Composite / Composite / Composite / Composite / Composite
MT6	Preformado / Preformed/ Préformé / Vorgeformt / Preformato	Metal / Metal / Metal / Metall / Metallo	E	4	Composite / Composite / Composite / Composite / Composite

Polaris

Palo mayor / Main mast / Grand mât
Hauptmast / Albero maestro

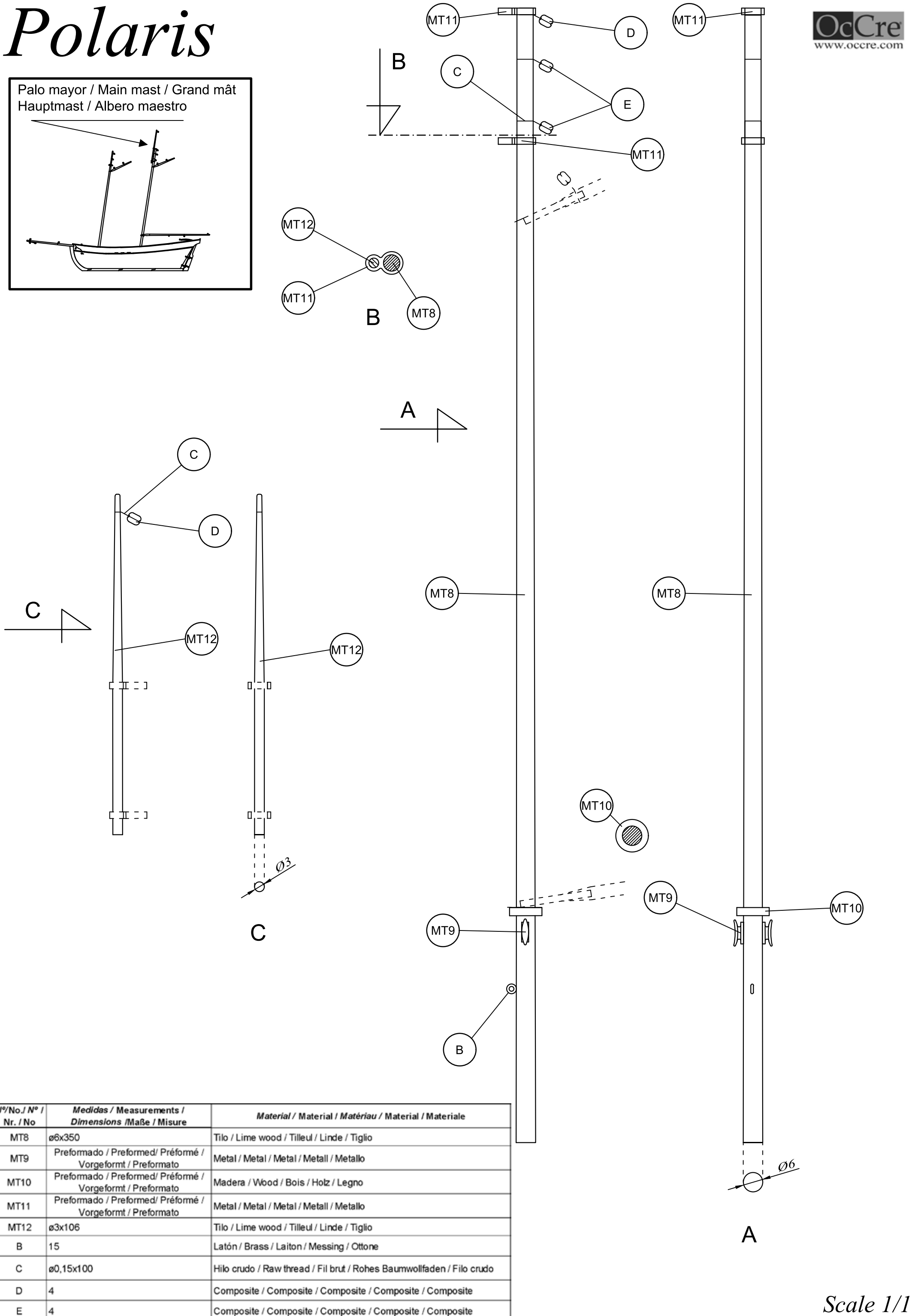
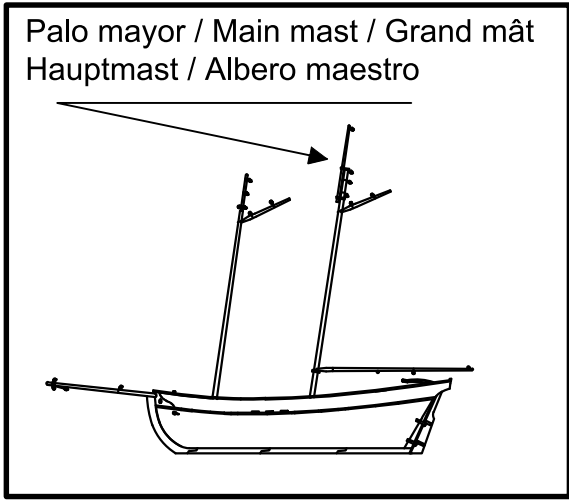

Nº/No. / N° / Nr. / No	Medidas / Measurements / Dimensions / Maße / Misure	Material / Material / Matériau / Material / Materiale
MT8	ø6x350	Tilo / Lime wood / Tilleul / Linde / Tiglio
MT9	Preformado / Preformed/ Préformé / Vorgeformt / Preformato	Metal / Metal / Metal / Metall / Metallo
MT10	Preformado / Preformed/ Préformé / Vorgeformt / Preformato	Madera / Wood / Bois / Holz / Legno
MT11	Preformado / Preformed/ Préformé / Vorgeformt / Preformato	Metal / Metal / Metal / Metall / Metallo
MT12	ø3x106	Tilo / Lime wood / Tilleul / Linde / Tiglio
B	15	Latón / Brass / Laiton / Messing / Ottone
C	ø0,15x100	Hilo crudo / Raw thread / Fil brut / Rohes Baumwollfaden / Filo crudo
D	4	Composite / Composite / Composite / Composite / Composite
E	4	Composite / Composite / Composite / Composite / Composite

Polaris

Palo mayor / Main mast / Grand mât
Hauptmast / Albero maestro

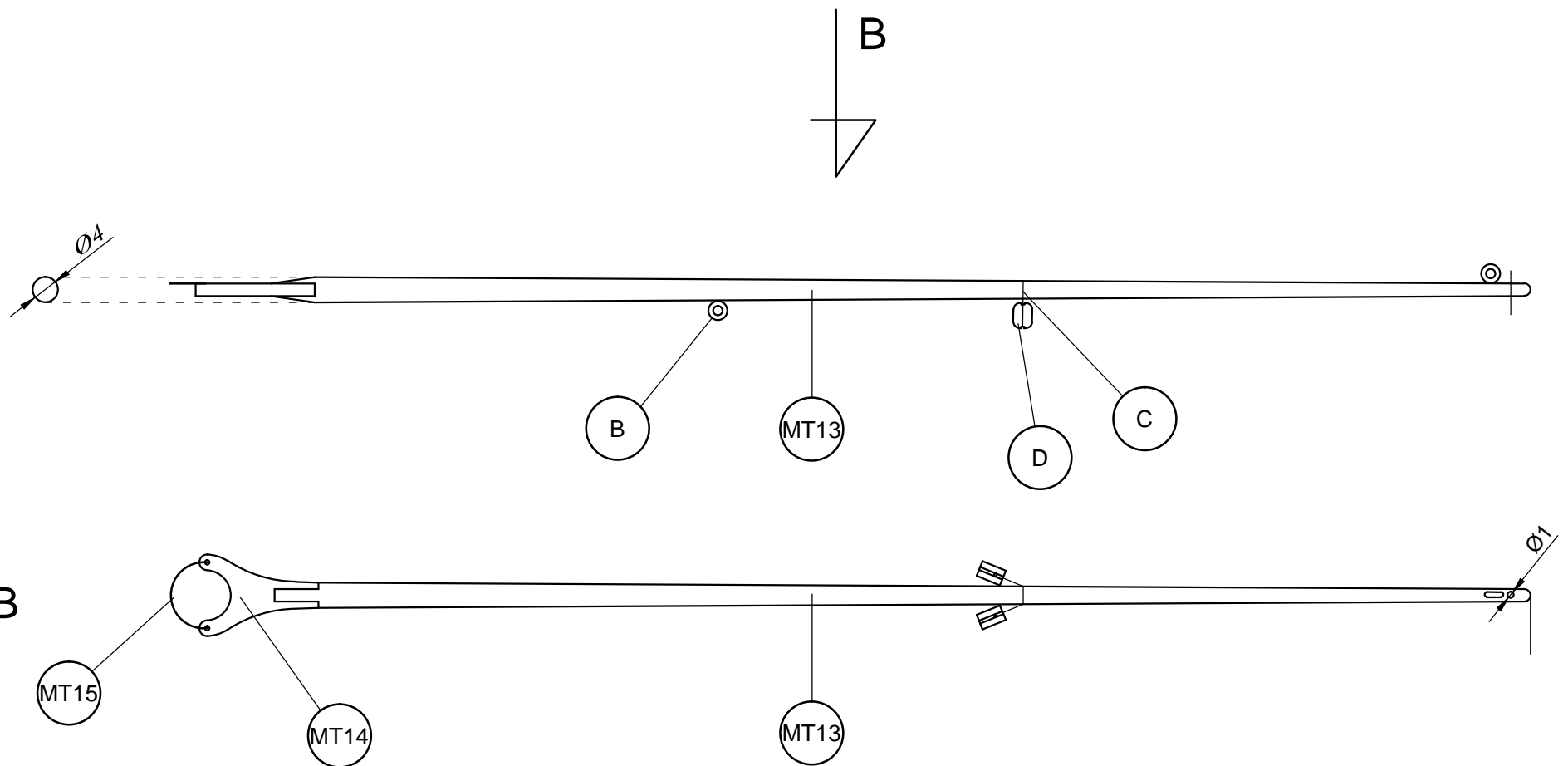
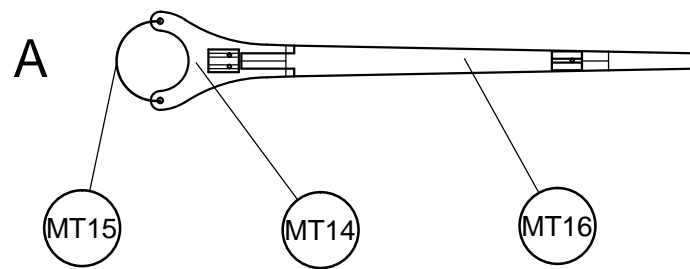
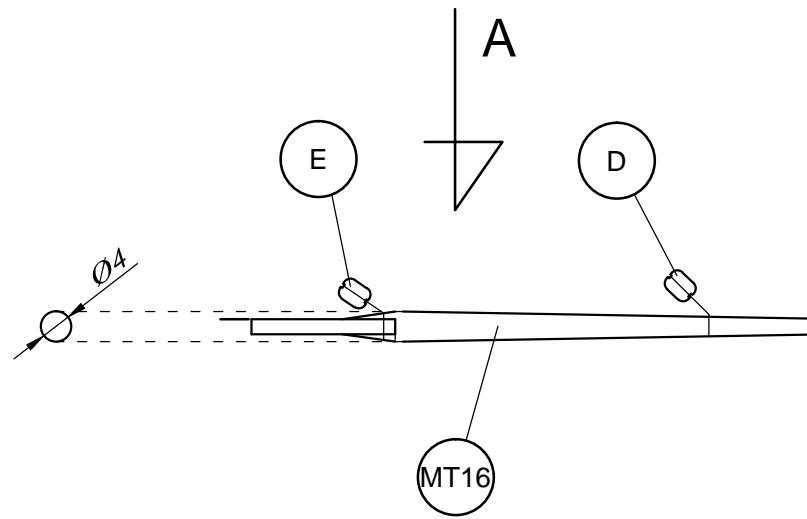

Scale 1/1

Nº/No./ N° / Nr. / No	Medidas / Measurements / Dimensions /Maße / Misure	Material / Material / Matériau / Material / Materiale	Nº/No./ N° / Nr. / No	Medidas / Measurements / Dimensions /Maße / Misure	Material / Material / Matériau / Material / Materiale
MT13	ø4x200	Tilo / Lime wood / Tilleul / Linde / Tiglio	B	15	Latón / Brass / Laiton / Messing / Ottone
MT14	Preformado / Preformed/ Préformé / Vorgeformt/ Preformato	Metal / Metal / Metal / Metall / Metallo	C	ø0,15x100	Hilo crudo / Raw thread / Fil brut / Rohes Baumwollfaden / Filo crudo
MT15	ø0,50x110	Hilo marrón / Brown thread / Fil brun / braunes Baumwollfaden / Filo marrone	D	4	Composite / Composite / Composite / Composite / Composite
MT16	ø4x60	Tilo / Lime wood / Tilleul / Linde / Tiglio	E	4	Composite / Composite / Composite / Composite / Composite

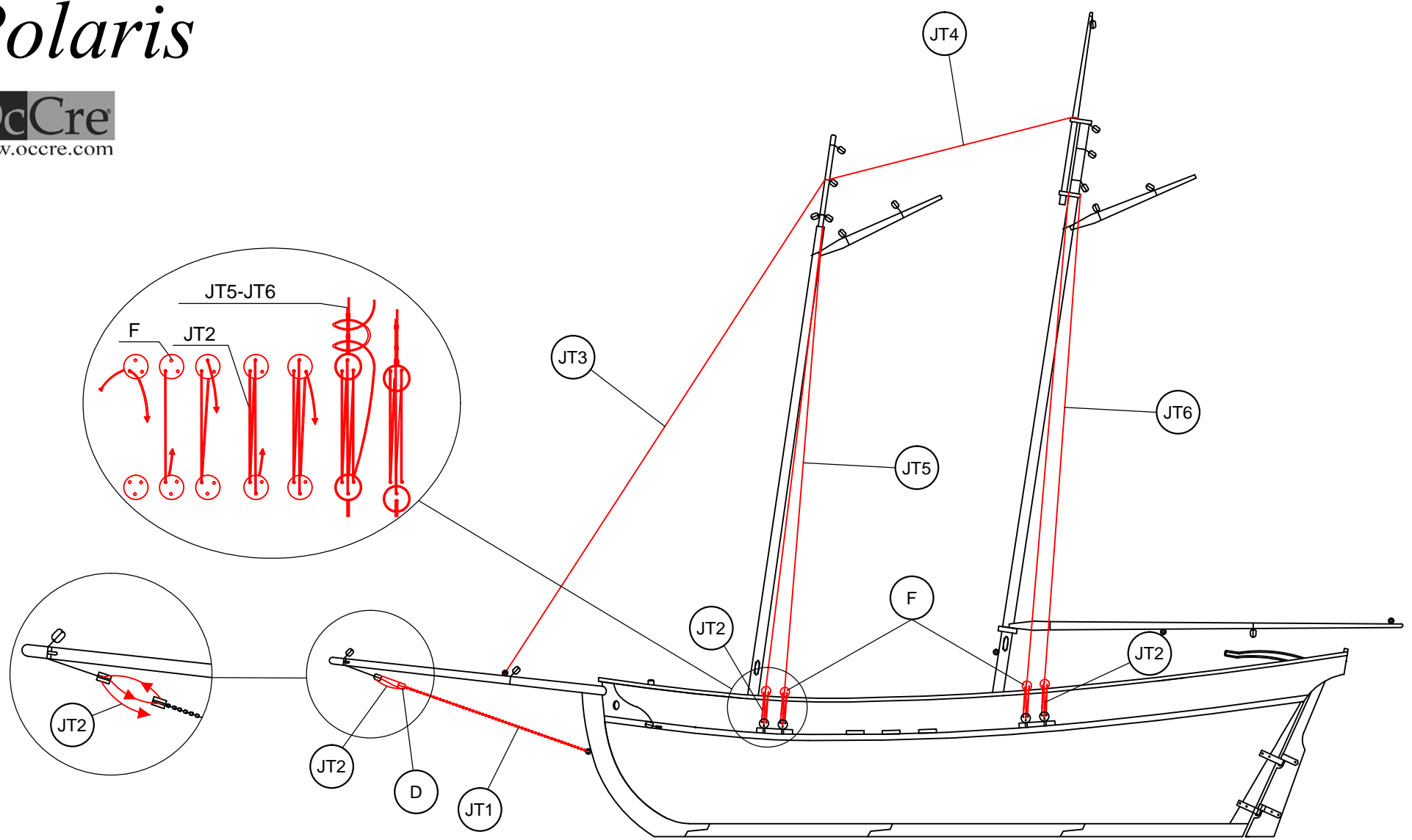

Nº/No./ N° / Nr. / No	Medidas / Measurements / Dimensions / Maße / Misure	Material / Material / Matériau / Material / Materiale	Nº/No./ N° / Nr. / No	Medidas / Measurements / Dimensions / Maße / Misure	Material / Material / Matériau / Material / Materiale
JT1	1x100	Latón / Brass / Laiton / Messing / Ottone	JT5	ø0,50x800	Hilo marrón / Brown thread / Fil brun /braunes Baumwollfaden / Filo marrone
JT2	ø0,15x150	Hilo crudo / Raw thread / Fil brut / Rohes Baumwollfaden / Filo crudo	JT6	ø0,50x980	Hilo marrón / Brown thread / Fil brun /braunes Baumwollfaden / Filo marrone
JT3	ø0,50x400	Hilo marrón / Brown thread / Fil brun /braunes Baumwollfaden / Filo marrone	D	4	Composite / Composite / Composite / Composite / Composite
JT4	ø0,50x250	Hilo marrón / Brown thread / Fil brun /braunes Baumwollfaden / Filo marrone	F	ø5	Composite / Composite / Composite / Composite / Composite

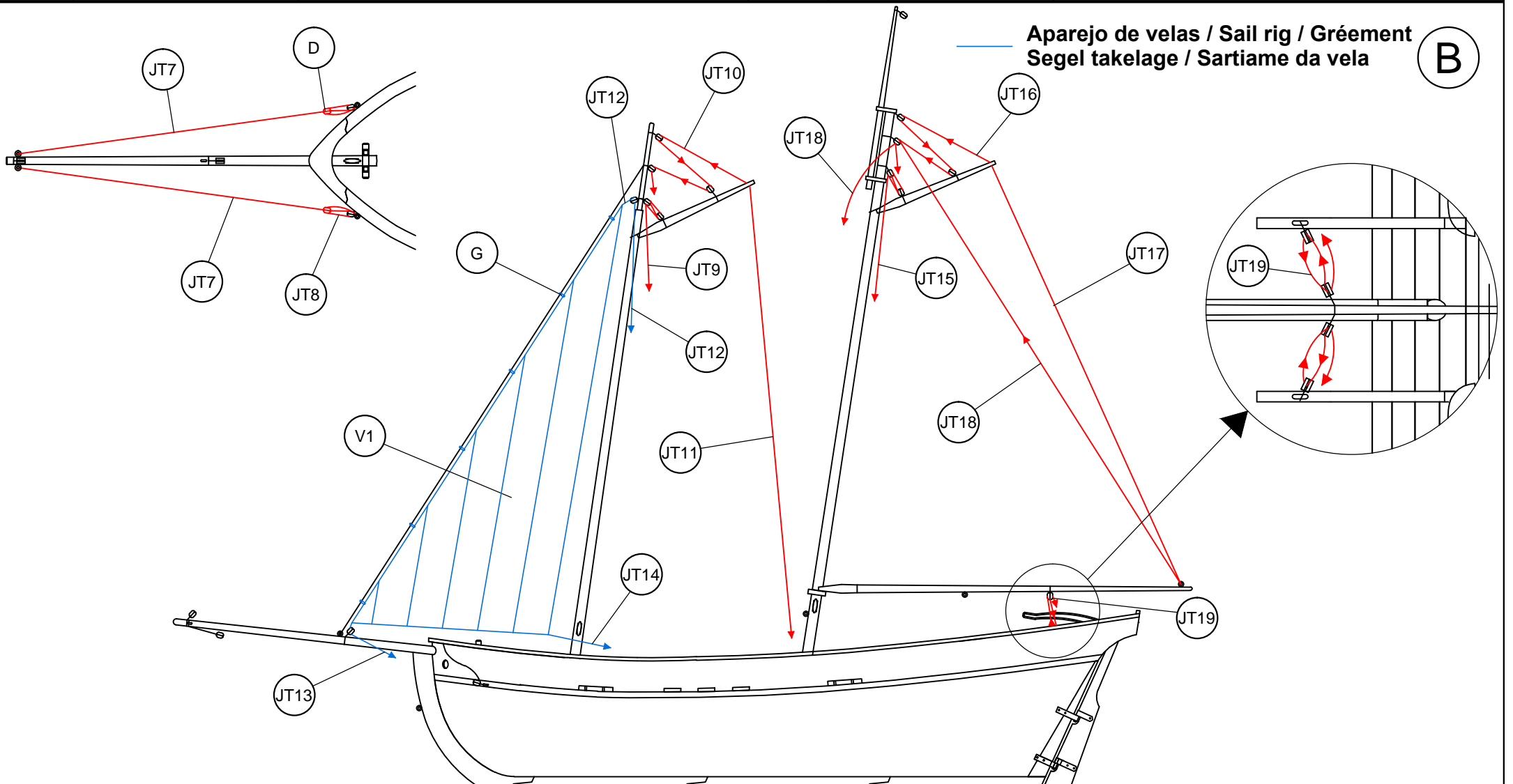

Aparejo de velas / Sail rig / Grément
Segel takelage / Sartiamo da vela

Nº/No./ N° / Nr. / No	Medidas / Measurements / Dimensions / Maße / Misure	Material / Material / Matériau / Material / Materiale	Nº/No./ N° / Nr. / No	Medidas / Measurements / Dimensions / Maße / Misure	Material / Material / Matériau / Material / Materiale
JT7	ø0,50x400	Hilo marrón / Brown thread / Fil brun /braunes Baumwollfaden / Filo marrone	JT14	ø0,15x300	Hilo crudo / Raw thread / Fil brut / Rohes Baumwollfaden / Filo crudo
JT8	ø0,15x200	Hilo crudo / Raw thread / Fil brut / Rohes Baumwollfaden / Filo crudo	JT15	ø0,15x600	Hilo crudo / Raw thread / Fil brut / Rohes Baumwollfaden / Filo crudo
JT9	ø0,15x500	Hilo crudo / Raw thread / Fil brut / Rohes Baumwollfaden / Filo crudo	JT16	ø0,15x500	Hilo crudo / Raw thread / Fil brut / Rohes Baumwollfaden / Filo crudo
JT10	ø0,15x600	Hilo crudo / Raw thread / Fil brut / Rohes Baumwollfaden / Filo crudo	JT17	ø0,15x550	Hilo crudo / Raw thread / Fil brut / Rohes Baumwollfaden / Filo crudo
JT11	ø0,15x400	Hilo crudo / Raw thread / Fil brut / Rohes Baumwollfaden / Filo crudo	JT18	ø0,15x700	Hilo crudo / Raw thread / Fil brut / Rohes Baumwollfaden / Filo crudo
V1	Preformado / Preformed/ Préformé / Vorgeformt	Tela / Cloth / Étoffe / Stoff / Tela	JT19	ø0,15x200	Hilo crudo / Raw thread / Fil brut / Rohes Baumwollfaden / Filo crudo
JT12	ø0,15x400	Hilo crudo / Raw thread / Fil brut / Rohes Baumwollfaden / Filo crudo	D	4	Composite / Composite / Composite / Composite / Composite
JT13	ø0,15x325	Hilo crudo / Raw thread / Fil brut / Rohes Baumwollfaden / Filo crudo	G	ø3	Latón / Brass / Laiton / Messing / Ottone

Polaris

OcCre
www.occre.com

Aparejo de velas / Sail rig / Gréement
Segel takelage / Sartieme da vela

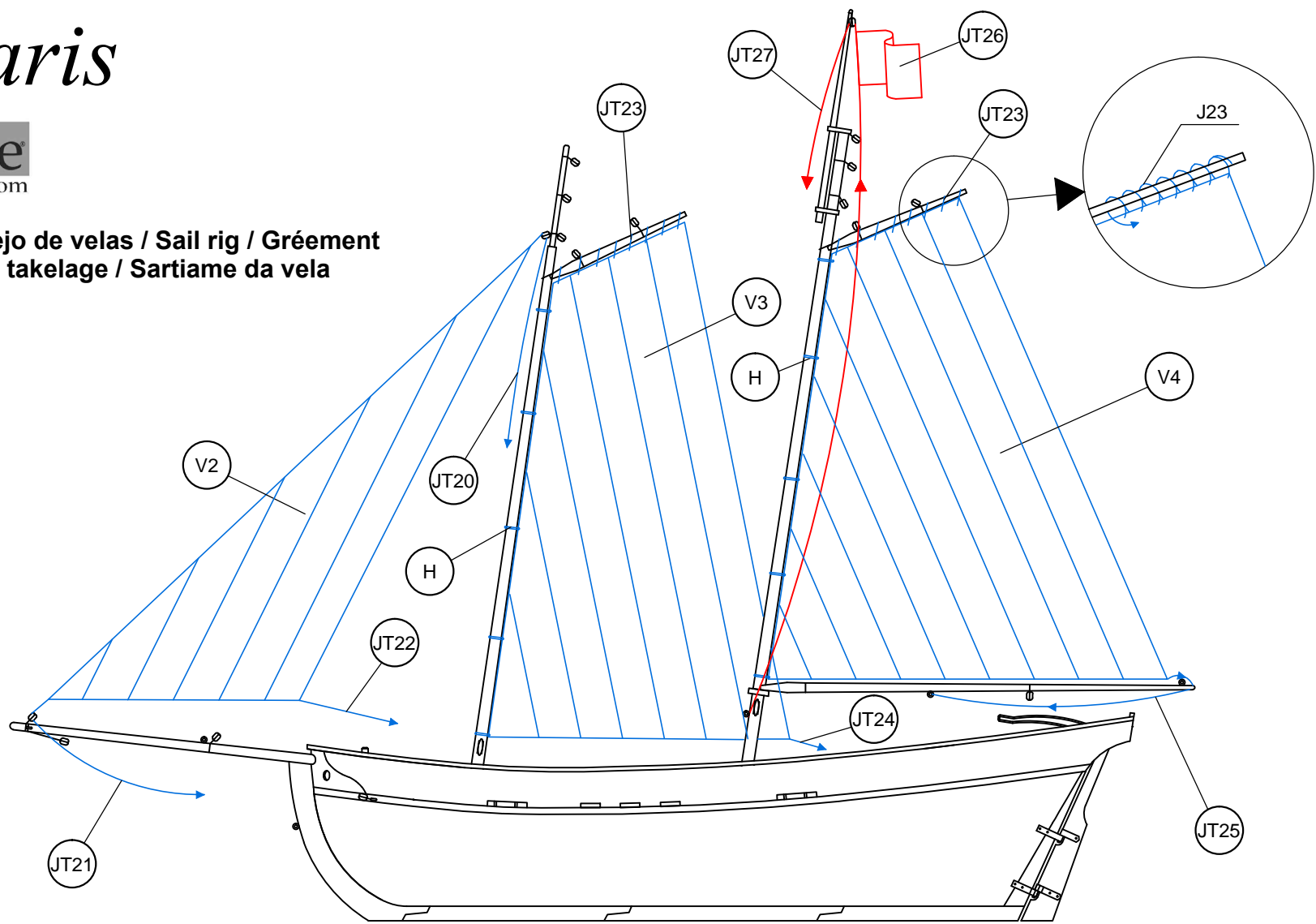

C

Nº/No./ N° / Nr. / No	Medidas / Measurements / Dimensions /Maße / Misure	Material / Material / Matériau / Material / Materiale	Nº/No./ N° / Nr. / No	Medidas / Measurements / Dimensions /Maße / Misure	Material / Material / Matériau / Material / Materiale
V2	Preformado / Preformed/ Préformé / Vorgeformt / Preformato	Tela / Cloth / Étoffe / Stoff / Tela	JT24	ø0,15x350	Hilo crudo / Raw thread / Fil brut / Rohes Baumwollfaden / Filo crudo
JT20	ø0,15x585	Hilo crudo / Raw thread / Fil brut / Rohes Baumwollfaden / Filo crudo	V4	Preformado / Preformed/ Préformé / Vorgeformt / Preformato	Tela / Cloth / Étoffe / Stoff / Tela
JT21	ø0,15x400	Hilo crudo / Raw thread / Fil brut / Rohes Baumwollfaden / Filo crudo	JT25	ø0,15x350	Hilo crudo / Raw thread / Fil brut / Rohes Baumwollfaden / Filo crudo
JT22	ø0,15x525	Hilo crudo / Raw thread / Fil brut / Rohes Baumwollfaden / Filo crudo	JT26	Preformado / Preformed/ Préformé / Vorgeformt / Preformato	Tela / Cloth / Étoffe / Stoff / Tela
JT23	ø0,15x1000	Hilo crudo / Raw thread / Fil brut / Rohes Baumwollfaden / Filo crudo	JT27	ø0,15x800	Hilo crudo / Raw thread / Fil brut / Rohes Baumwollfaden / Filo crudo
V3	Preformado / Preformed/ Préformé / Vorgeformt / Preformato	Tela / Cloth / Étoffe / Stoff / Tela	H	ø10	Latón / Brass / Laiton / Messing / Ottone

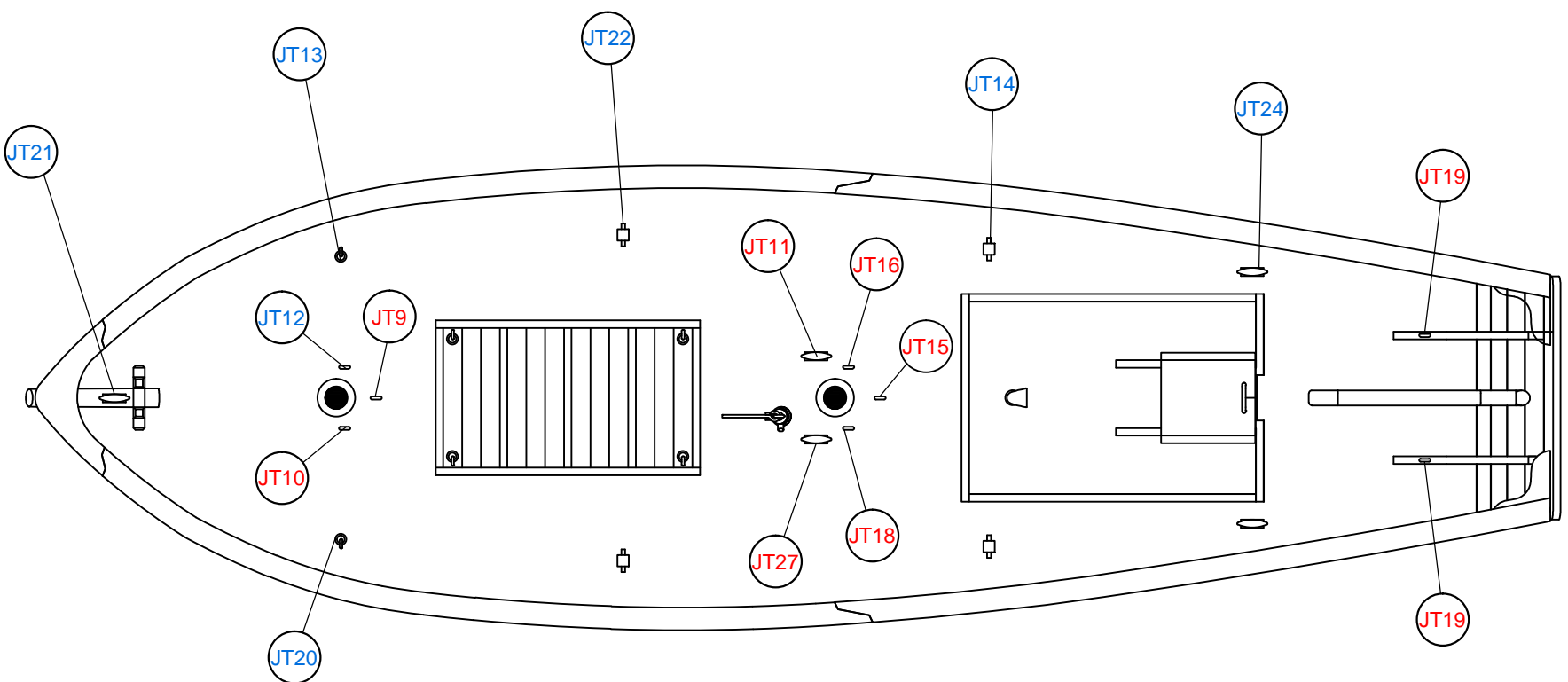

D